



Viz Multiplay User Guide

Version 2.5





Copyright © 2019 Vizrt. All rights reserved.

No part of this software, documentation or publication may be reproduced, transcribed, stored in a retrieval system, translated into any language, computer language, or transmitted in any form or by any means, electronically, mechanically, magnetically, optically, chemically, photocopied, manually, or otherwise, without prior written permission from Vizrt. Vizrt specifically retains title to all Vizrt software. This software is supplied under a license agreement and may only be installed, used or copied in accordance to that agreement.

Disclaimer

Vizrt provides this publication “as is” without warranty of any kind, either expressed or implied. This publication may contain technical inaccuracies or typographical errors. While every precaution has been taken in the preparation of this document to ensure that it contains accurate and up-to-date information, the publisher and author assume no responsibility for errors or omissions. Nor is any liability assumed for damages resulting from the use of the information contained in this document. Vizrt’s policy is one of continual development, so the content of this document is periodically subject to be modified without notice. These changes will be incorporated in new editions of the publication. Vizrt may make improvements and/or changes in the product (s) and/or the program(s) described in this publication at any time. Vizrt may have patents or pending patent applications covering subject matters in this document. The furnishing of this document does not give you any license to these patents.

Technical Support

For technical support and the latest news of upgrades, documentation, and related products, visit the Vizrt web site at www.vizrt.com.

Created on

2019/02/18

Contents

1	Introduction.....	9
1.1	Document Structure.....	9
1.2	Related Documents.....	10
1.3	Feedback and Suggestions.....	10
2	Viz Multiplay.....	11
2.1	Key Features.....	12
2.2	System Diagrams.....	13
2.3	End-to-End Workflows.....	14
2.3.1	Basic Workflow.....	14
2.3.2	Extended Workflow.....	14
2.4	User Workflows.....	14
2.4.1	For the Journalist.....	15
2.4.2	In the Control Room.....	15
2.4.3	For the Presenter.....	15
3	Setup.....	16
3.1	Installing Viz Multiplay.....	16
3.1.1	Installation Prerequisites.....	16
3.1.2	Required reading.....	16
3.1.3	Required and optional components/products.....	16
3.1.4	Viz Multiplay Installer.....	16
3.1.5	Licensing.....	17
3.2	Setting up the Viz Multiplay Client.....	17
3.2.1	Viewing in a Browser.....	17
3.2.2	Connecting to Media Sequencer.....	18
3.2.3	Configuring Asset Search in Viz One.....	18
3.3	Viz Multiplay Settings.....	19
3.3.1	General Tab.....	19
3.3.2	Profiles Tab.....	23
3.3.3	Workspaces Tab.....	25
3.3.4	Inboxes Tab.....	27
3.3.5	Servers Tab.....	28
3.3.6	Color correction tab.....	30
3.4	Preparing Channels and Shows.....	36
3.4.1	Profiles and Channels.....	36

3.4.2	Shows and Playlists	37
4	Using Viz Multiplay	39
4.1	Overview of the Interface	39
4.2	Configuring Your Display	40
4.2.1	Layout Options	40
4.2.2	Toolbar	40
4.2.3	Hide Sources Pane and Show pane	40
4.2.4	Settings	41
4.2.5	On Air Mode	41
4.2.6	1-Tap Mode	41
4.2.7	Set up on a Tablet	42
4.2.8	Resizing and collapsing channels	42
4.3	Importing graphics	45
4.3.1	Basic scene import	45
4.4	Work with Shows, Playlists and Groups	47
4.4.1	Open	47
4.4.2	Browse Shows Window	48
4.4.3	Show Pane	49
4.4.4	Cleanup	55
4.4.5	Initialize	56
4.5	Move elements	57
4.5.1	Move elements in off air mode	57
4.5.2	Moving elements in on air mode	62
4.6	Sources Pane	65
4.6.1	Media Tab	66
4.6.2	Inbox Tab	70
4.6.3	GFX Tab	71
4.6.4	Videowall Tab	73
4.6.5	Templates Tab	75
4.7	Workspaces	80
4.7.1	Hiding channels	81
4.7.2	Shortcuts per workspace	82
4.8	Arming and Taking Elements	83
4.8.1	Media Pane	83
4.8.2	Armed	87
4.8.3	Program	88
4.8.4	Arm and Take Multiple Elements	91

4.8.5	Reload Scene	91
4.9	Shortcuts Bar	93
4.9.1	Elements in the Shortcuts bar	93
4.9.2	Layers	96
4.9.3	Working with the Shortcuts Bar	96
4.9.4	GFX preset mode	98
4.10	Status and Logs	101
4.10.1	Status Bar	101
4.10.2	Logs	101
4.10.3	Version Information	101
4.11	Editing Graphics, Videos and Images	101
4.11.1	Editing Images	102
4.11.2	Editing Videos	104
4.11.3	Editing Graphics	106
4.11.4	Editing Presets	112
4.11.5	Renaming playlist entries	116
4.12	Keyboard Shortcuts	117
4.12.1	Main window	118
4.12.2	Profile Configuration	119
4.12.3	Video Editor	120
4.12.4	Workspaces	120
4.12.5	Video Wall Designer	121
5	Tools	122
5.1	Video Wall Setup Tool	122
5.1.1	Video Wall Setup Fields	123
5.1.2	Clip Channels	124
5.1.3	Multi Video Wall Control	124
5.1.4	External Preview	125
5.2	Video Wall Designer	125
5.2.1	Areas of the Video Wall Designer	126
5.2.2	Channel Bin	128
5.2.3	Presets Bin	128
5.2.4	Channel Details	129
5.2.5	Channel Layout Editor	130
5.2.6	Active Areas Editor	133
5.3	Preset Content Editor	135
5.3.1	Open the Preset Content Editor	135

5.4	Advanced Settings	137
5.4.1	Offset	137
5.4.2	Color Correction on the GPU	137
5.4.3	Show Viz expert mode	138
6	Workflows.....	139
6.1	Glossary of terms.....	139
6.2	Setup and organize content	140
6.2.1	Setting up a preview server	140
6.2.2	Getting started with shows and profiles	141
6.2.3	Shortcuts	146
6.2.4	Working with graphics	147
6.2.5	Inboxes	151
6.2.6	Working with images and videos.....	152
6.2.7	Edit graphics, videos and images	154
6.3	Preparing and playing out content	157
6.3.1	Preparing content	157
6.3.2	Playing out content.....	159
6.4	Setup and configure single and multiple video walls	159
6.4.1	Get started with one video wall	160
6.4.2	Screens with different sizes and resolutions.....	167
6.4.3	Combine video walls	168
6.4.4	Setup and use external preview.....	170
6.5	Presets.....	171
6.5.1	Creating presets	172
6.5.2	Using your new presets.....	173
6.5.3	Fine tune size or position of GFX channels	174
6.5.4	Workflow without using the VideoWall tab	174
6.6	Creating prefilled walls	175
6.6.1	Common workflow.....	175
6.6.2	Adapt the GUI to prefilled walls	177
6.7	Working with Viz Pilot and MOS content.....	178
6.7.1	Viz Pilot playlists	179
6.7.2	MOS workflow.....	179
6.7.3	Pilot Data Server	181
6.8	Using a switcher	183
6.8.1	Background	183
6.8.2	Configuring the Media Sequencer	184

6.8.3	Learning elements	185
6.8.4	Recalling and trigger.....	187
6.9	Using Graphic Hub image staging	188
6.9.1	Required components	188
6.9.2	Configuration and setup	188
6.9.3	Workflow in Viz Multiplay.....	189
6.10	Using Datapath Fx4 display controller.....	191
6.10.1	Connecting the devices.....	191
6.10.2	Calculating resolution.....	193
6.10.3	Setting up the video wall in Multiplay.....	194
7	Troubleshooting and Common Issues	198
7.1	Troubleshooting	198
7.1.1	The Viz Engine output keeps going black randomly	198
7.1.2	When I run Viz Engine in fullscreen my graphic quality downgrades to SD.....	198
7.1.3	Video transfer from a search result to a GFX channel stays on 0%	198
7.1.4	Video transfer from a search result gives errors	199
7.1.5	The search panel looks disabled and it returns an error about Viz One	199
7.1.6	My clips/graphics do not appear on the output engines when I put them on air	199
7.1.7	No thumbnails for my graphics appear in Viz Multiplay.....	199
7.1.8	The show opens but doesn't display any stories or content.....	199
7.1.9	I have set up profiles but get an error about No Viz/video program	200
7.1.10	Problems running Preview Server	200
7.2	Known Issues.....	200
7.3	Tricks and Hints.....	200
7.3.1	Filling clips/images in GFX channels instead of letterboxing	201
7.3.2	Enabling transitions between video clips	202
7.3.3	Tricks and Hints for Viz Engine 3.8.2 or later	205
7.3.4	Tricks and Hints for NVIDIA Mosaic.....	205
7.3.5	Performance Issues.....	205
7.4	Frequently Asked Questions.....	207
7.4.1	How do I set up a video wall with screens with different aspects and resolutions?.....	207
7.4.2	Does Viz Multiplay support clips with non broadcast format?.....	207
7.4.3	Can I use Viz Pilot instead of Viz Trio?	208
7.4.4	What is the technical limitation of playing HD clips?.....	208
7.4.5	Does the playlist update after changes in the newsroom system rundown?	208
7.4.6	Can Viz Multiplay play out graphics created via Viz Pilot templates?.....	208
7.4.7	Can Viz Multiplay open a playlist from Viz Pilot?	208

7.4.8	Can Viz Multiplay open a MOS rundown? What is the workflow?	209
7.4.9	How do I run movie clips?	209
7.4.10	Can we have live input in one of the monitors or across a group?	209
7.4.11	Can I use a touch screen monitor in my live-to-air control room?.....	209
7.4.12	Can Viz Multiplay be controlled by Viz Mosart, VDCP, Viz Trio or Viz Pilot?	209
7.4.13	Can Viz Multiplay be integrated into a Mosart workflow?.....	209
7.4.14	Can we use Social TV as a source for Viz Multiplay?	209
7.4.15	Do I need a Viz One to feed Viz Multiplay with clips and images?.....	210

1 Introduction

Viz Multiplay gives broadcasters a powerful tool for controlling studio screen content. The simple interface can be used in the control room or by the presenter in the studio.

The main features of Viz Multiplay are:

- Send content quickly to multiple screens,
- Dynamic control from a single interface,
- Controls live, video, graphics and still content.



1.1 Document Structure

This User Guide includes both information on the technical aspects of installation and maintenance, as well as instructions for end users.

- [Viz Multiplay](#) provides an overview of the features of Viz Multiplay and the various workflows that it supports.
- [Setup](#) describes how to install and run Viz Multiplay, and how to set it up to work with other applications, such as Viz Trio and newsroom control systems.
- [Using Viz Multiplay](#) describes how to use the Viz Multiplay application on your desktop or tablet device.
- [Tools](#) describes the set of editors within Viz Multiplay that are used during setup of videowalls and studios.
- [Workflows](#) explains how to setup and use Viz Multiplay in step-by-step instructions.
- [Troubleshooting and Common Issues](#) lists tips for troubleshooting Viz Multiplay.

1.2 Related Documents

- [Viz Trio User Guide](#): How to use the **Viz Trio** client, and configure the output channels and playout pages in shows, based on templates.
- [Viz Engine Administrator Guide](#): Setup the Viz Engine including a correct Video Wall Configuration.
- [Graphic Hub Administrator Guide](#): Setup Graphic Hub with image staging, default ingest folders etc.
- For more information on integrating with **Viz One**, please contact your local Vizrt customer support team at www.vizrt.com.

For more information about all of the Vizrt products, visit:

- www.vizrt.com
 - [Vizrt Documentation Center](#)
 - [Viz University](#)
 - [Vizrt Forum](#)
-

1.3 Feedback And Suggestions

We welcome your feedback and suggestions regarding Vizrt products and this documentation.

To give feedback and/or suggestions, please contact your local Vizrt customer support team at <http://www.vizrt.com>.

2 Viz Multiplay



Viz Multiplay is a control application that is designed for controlling the increasing number of screens that are now present in studios. It can be used to take graphics, images or video clips on air to all the screens in the studio.

Viz Multiplay can control an individual screen or trigger content to multiple screens simultaneously. Screens of different resolutions and aspect ratios can be incorporated, allowing for a wide range of studio configurations.

Media elements can be graphics elements rendered by the Viz Engine, video clips, or SDI live inputs.

Viz Multiplay can be used in the control room in combination with Viz Trio to manage all the screens. It can also be used by a presenter, allowing them to drive the graphics or videos themselves. All instances of Viz Multiplay are linked, so users in the control room and studio can work together.

Viz Multiplay is built on top of the existing Vizrt infrastructure, so it can be used together with your other Vizrt applications and Viz Engine outputs.

The application itself is browser based, so it can run on any computer or a tablet, and has an easy-to-use interface. Viz Multiplay gives broadcasters a simple way to control studio screen content from a single interface.

This section contains the following topics:

- [Key Features](#)
- [System Diagrams](#)
- [End-to-End Workflows](#)
- [User Workflows](#)

2.1 Key Features



The key features of Viz Multiplay are:

- Multiple channel/output control
- Anchor control
- Display of video, graphics and still images
- Multiplatform control
- MOS support
- Live video control
- Dynamic shows
- SD/HD/4K SDI and IP output
- Integration with Viz Trio, Viz One, Media Service and Pilot Data Server
- Touch-screen friendly for playout functions
- Collaboration between users

New main features in Viz Multiplay 2.5:

- Basic scene import directly from Graphic Hub.
- Easier access to overlapping GFX channels in the Filled Preset Editor.
- Shortcuts can be private per Workspace.
- Ability to lock playout channels.
- Access to Viz Layer on elements in the Main channel.
- Added setting for whether clips should loop per default.
- More keyboard shortcuts.
- Visual indication for possible keyboard shortcuts.
- Possibility to initialize single element.
- Show the renderer status for graphics and clips (loaded and prepared).

2.2 System Diagrams

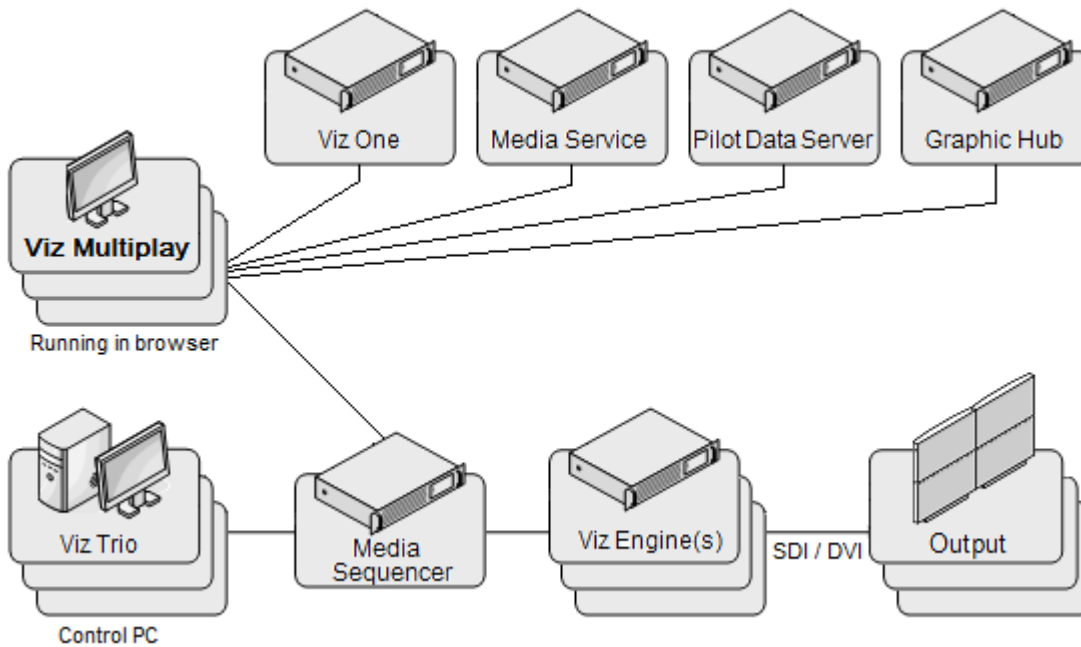

- Viz Multiplay is compatible with graphics from **Viz Trio** or **Viz Template Wizard**. Shows from Viz Trio are available in Viz Multiplay.
- Viz Multiplay can access and use templates and elements in a **Pilot Data Server**.
- Viz Multiplay is hosted on a URL on the **Media Sequencer**. Any number of Viz Multiplay clients can connect to the same Media Sequencer, which provides the scheduling for playout.
- The **Viz Engine(s)** are used for playout:
 - The video wall feature means that up to 4 DisplayPort outputs can come from a single GPU in a Viz Engine. Using either more GPUs, the number of outputs is limited to 16. Using one or more Datapath Fx4 display controllers, the number of outputs is unlimited. See the Release Notes for hardware requirements, and note that you should check the performance of your scenes when using complex configurations.
 - Standard SDI based playout (with one Viz Engine for each output).
- Viz Multiplay can also access the media assets stored in **Viz One** and **Media Service**.

2.3 End-To-End Workflows

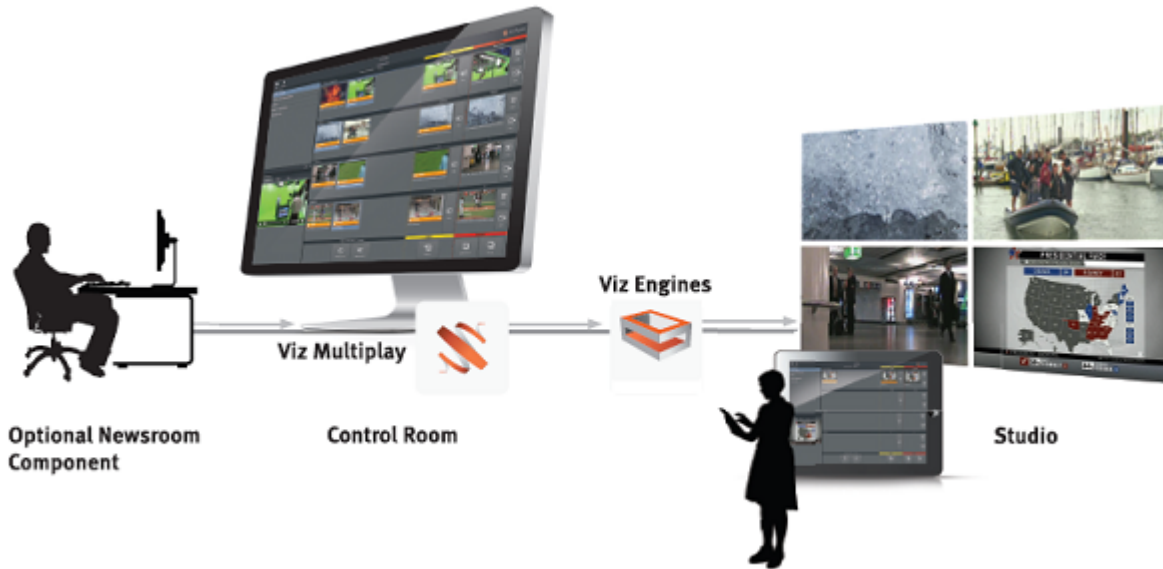

2.3.1 Basic Workflow

1. In the studio Viz Multiplay is used to create shows.
2. Operators use Viz Multiplay to manage the shows and trigger content for each screen.
3. Viz Engines composite graphics and video in real-time in SD/HD/4K SDI and IP streams.
4. In the studio, monitors and video walls are filled with the content controlled by Viz Multiplay.

2.3.2 Extended Workflow

1. Journalists create shows in Viz Trio or the newsroom control system.
2. In the control room, operators use Viz Multiplay to manage the shows, trigger content for each screen, and define content for the journalist in the studio to control.
3. Viz Engines composite graphics and video in real-time in SD/HD/4K SDI and IP streams.
4. The presenter in the studio controls screen content live with the Viz Multiplay touch-screen interface.
5. In the studio, monitors and video walls are filled with the content controlled by Viz Multiplay.

2.4 User Workflows

This section contains information about the following workflows:

- [For the Journalist](#)
- [In the Control Room](#)
- [For the Presenter](#)

2.4.1 For the Journalist

1. Prepare the show. Either:
 - Use Viz Multiplay to browse for content (images, clips and graphics) and add to a show.
 - Prepare a show in Viz Trio or your newsroom control system.
2. Define which channel(s) the content will be triggered on.

2.4.2 In the Control Room

The operator either triggers the show as it was created in the rundown, or rearranges elements on-the-fly.

1. Prepare a normal rundown in the control room or newsroom (Viz Multiplay is fully MOS enabled so clips can be managed through the normal newsroom workflow using our ActiveX component).
2. In Viz Multiplay, open a show.
3. Select and activate a profile.
4. Select and edit elements from the Sources pane. For example, media items, graphics, video wall layouts, or Viz Pilot templates.
5. Drag elements and arrange them in each channel:
6. Edit or preview the selected elements.
7. Drag or tap elements or video wall layouts to arm them, or take them to air:
Viz Trio can trigger events from Viz Multiplay and control the content available in Viz Multiplay. Manual changes to the Viz Multiplay show are **immediately reflected** in the Viz Trio show and vice versa.

All instances of Viz Multiplay are linked, so changes in one are reflected to all users. Users can **work in collaboration**, for example, a control room operator sets up elements for the studio presenter to take to air.

2.4.3 For the Presenter

The presenter can control the output on screen by using Viz Multiplay on a tablet.

1. Select a media element to play.
2. Drag or tap elements to take them to air.
The presenter's tablet can automatically follow the control room's Viz Multiplay client to reduce the number of actions required by the presenter.

3 Setup

Viz Multiplay is installed on top of the Media Sequencer, and is then run via a standard Internet browser.

This section contains the following topics:

- [Installing Viz Multiplay Server](#)
- [Setting up the Viz Multiplay Client](#)
- [Viz Multiplay Settings](#)
- [Preparing Channels and Shows](#)

3.1 Installing Viz Multiplay

3.1.1 Installation Prerequisites

Viz Multiplay is a web page hosted on a Media Sequencer, so a Media Sequencer must be installed on the computer hosting Viz Multiplay.

3.1.2 Required reading

A successful installation hinges almost entirely on a comprehensive understanding of the *Video Wall Configuration* section in the [Viz Engine manual](#).

Therefore, it is extremely important to review this section to ensure that your video wall setup is working properly before considering the other required components in this list.

3.1.3 Required and optional components/products

See release notes for a list of products and components, and their recommended version numbers.

3.1.4 Viz Multiplay Installer



Note:

A Viz Multiplay licensed Media Sequencer dongle is required on the server machine. See [Licensing](#).

1. On the Media Sequencer machine, run the Viz Multiplay installer file `VizMultiplay-[version].exe`
This will install the core files for Viz Multiplay, including documentation, and will add shortcuts to the desktop and Start menu which point to the application's URL.
The default installation location is: `<MEDIA_SEQUENCER>\www\app\vizmultiplay`
e.g. `%ProgramFiles%\Vizrt\Media Sequencer\www\app\vizmultiplay`
The default location is recommended, but can be configured if required.

 **Note:**
Media Sequencer must be running before starting the Viz Multiplay installation. The Media Sequencer acts as a web server, serving out the Viz Multiplay web application.

3.1.5 Licensing

Viz Multiplay requires a Viz Multiplay-licensed Media Sequencer dongle on the server machine. If a valid license is not present, a warning message appears when the Viz Multiplay client is started, and every 20 minutes thereafter.

3.2 Setting Up The Viz Multiplay Client

This section contains the following topics:

- [Viewing in a Browser](#)
- [Connecting to Media Sequencer](#)
- [Configuring Asset Search in Viz One](#)

3.2.1 Viewing in a Browser

It is possible to access Viz Multiplay from an internet browser. The URL to access Viz Multiplay is:

<ms_host>:8580/app/vizmultiplay/vizmultiplay.html

Desktop

For using Viz Multiplay on a desktop, we recommend using the latest version of Chrome, Firefox or Safari.

To run Viz Multiplay on a **touch screen**, Firefox is the recommended browser, as it fully supports touch screen drag-and-drop functionality. Touch screens work well for the playout functions of Viz Multiplay, but for editing (such as Profile Configuration and the Video Wall Designer), we recommend using a mouse and keyboard.

 **Note:**
The recommended minimum screen resolution is 1280 x 720

Tablets

The Viz Multiplay interface adapts automatically to smaller screens such as tablets.



3.2.2 Connecting to Media Sequencer

Viz Multiplay and your other control clients (e.g. Viz Trio) must be connected to the same Media Sequencer (MSE), in order to share a show. It is possible to host Viz Multiplay on one Media Sequencer and make it connect to the content of another Media Sequencer by adding the URL parameter `mse=<host>` to the URL:

```
<ms_host>:8580/app/vizmultiplay/vizmultiplay.html?mse=<mse_hostname>
```



Note:

Media sequencer stores all playlists/shows and makes them available to all control applications connected to it.

3.2.3 Configuring Asset Search in Viz One



Note:

If you require assistance configuring your Viz One, please contact your local Vizrt customer support team at www.vizrt.com.

Once Viz Trio is configured to work with Viz One, the Viz Multiplay integration is straight forward. In order to make the asset search from Viz Multiplay work, the following settings are required:

Viz One Login

A Viz One account is required in order for Viz Multiplay to log in. Viz Multiplay can use the same account as Viz Trio. If it is a separate account, it must have the same access rights as the one used by Viz Trio.

**Note:**

Viz Multiplay runs in a web browser, so the web browser handles authentication. This means that the user must enter username and password in a dialog box provided by the browser. It is up to the browser to cache the credentials.

To *configure* Viz One in Viz Multiplay:

1. Go to **Settings > Servers**.
2. Enter the hostname in the Viz One input box and press TAB. Viz Multiplay will fill in the rest of the URL.

To *configure* Viz One in Viz Trio:

1. Open Viz Trio.
2. Select **Configuration > Viz One** and enter the Service Document URL, Username and Password.

Internet Explorer Settings

If using Internet Explorer, you must allow cross-origin requests (this is supported automatically in Chrome and Firefox).

1. Open Internet Explorer.
2. Select **Tools > Internet Options > Security > Custom Level**.
3. Browse down to **Miscellaneous**, click **Enable for Access data sources across domains**.

3.3 Viz Multiplay Settings

Open the Settings window from the toolbar:

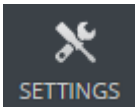

It has the following tabs:

- [General Tab](#)
- [Profiles Tab](#)
- [Workspaces Tab](#)
- [Inboxes Tab](#)
- [Servers Tab](#)
- [Color correction tab](#)

3.3.1 General Tab

Settings > General

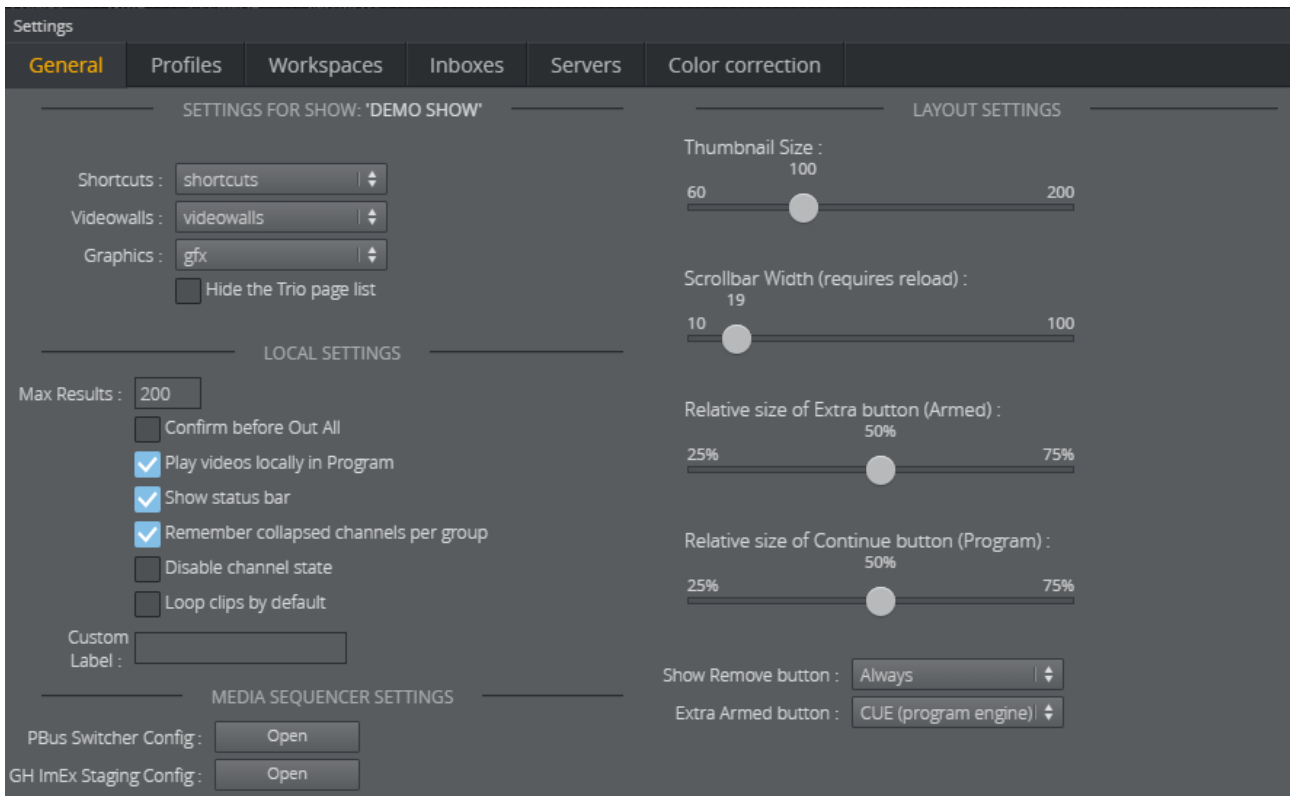

The settings are as follows:

- **SETTINGS FOR SHOW:**

- **Shortcuts:** Select the playlist that contains your preset layouts and background scenes. The shortcuts are then displayed in the [Shortcuts Bar](#) at the top of the main window.
- **Videowall:** Select the playlist that contains your videowall preset layouts. You can drag the presets onto the [Shortcuts Bar](#) or the main channel, edit them in the [Video Wall Designer](#) and create filled presets in the [Preset Content Editor](#).
- **Graphics:** Select the playlist that contains graphics imported with Trio. You can drag Trio pages into the Media Column in Viz Multiplay and edit them in the [Preset Content Editor](#).
- **Hide the Trio page list:** Check this box to hide the Trio page list. This can be useful if the Pilot workflow is used.

- **LOCAL SETTINGS**

- **Max Results:** Enter the max number of elements to be listed in the Media tab and Pilot data elements in the Templates tab in Sources.



Note:

The current search refreshes when the setting is changed.

- **Confirm before Out All:** Enables a dialogue box, which appears after clicking **Out All**, asking if you want to take out all elements.

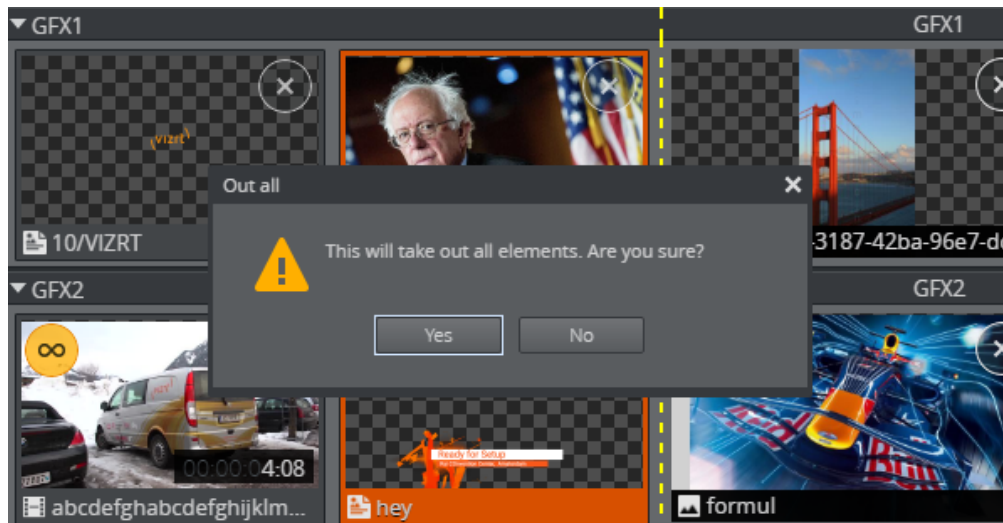

- **Play videos locally in Program:** When enabled, clips will display a preview in the [Program](#) column when they are taken to air. When disabled, only a thumbnail will be displayed.



Note:

See [Armed](#) and [Program](#) for more information about cueing content.

- **Show Status Bar:** Show or hide the [Status Bar](#) at the bottom of the screen.
- **Remember collapsed channels per group:** If checked, Multiplay stores the collapsed/expanded state for each channel, per group. This is handy if one group contains content for a subset of the channels, while another group mainly contains content for another subset.
- **Disable channel state:** When checked, Multiplay will show the last taken element in the Program column. This element is private for Multiplay. The Out and Continue buttons will operate only on this element. Other clients will not update the Program column. When unchecked, Channel State is used - given that the Media Sequencer version is equal to or above 5.0. When Channel State is used - the Program column will contain a more accurate snapshot of the content of the renderer - and the Out/Continue buttons will operate on all the current layers in the renderer.
- **Loop clips per default:** Decides whether clips dragged in from a Media search should loop per default or not.

- **Custom Label:** Enter a free text and specify the background and foreground color to be displayed as a label in the Viz Multiplay toolbar area. This can be handy to indicate which video wall or studio the user interface is controlling with a quick look.

This will be displayed in Viz Multiplay:

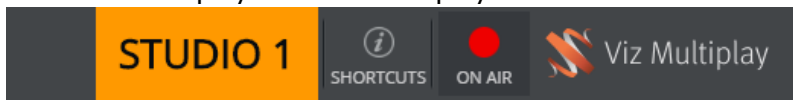

• LAYOUT SETTINGS

- **Thumbnail size:** Controls the appearance of media icons in the Media column.
- **Scrollbar Width:** Decides the width (in pixels) of the vertical scrollbar in the Media pane. This can be handy when operating on a touch device. Default is 19.
- **Relative Size of Extra button (Armed):** Decides the relative size of the extra-button (see below) in the Armed column.
- **Relative Size of Continue button (Program):** Decides the relative size of the Continue button in the Program column. This can be handy to prevent the operator from accidentally clicking Out instead of Continue in stressed situations. The Continue button can then be increased to be more visually dominant .
- **Show Remove button:** Select when to show the remove button (the X) on playlist and elements. Use this to prevent accidental removal of elements and playlists. The choices are:
 - Always
 - Only when Off Air
 - Never
- **Extra Armed button:** Select an additional button in the armed column. The choices are:
 - None
 - **CONTINUE:** Performs a continue operation on the external preview engine for a video wall, if preview is configured.
 - **CUE:** Set the armed element ready in its first frame in the Program column.

• MEDIA SEQUENCER SETTINGS

- **PBus Switcher Config** button: Available if the Media Sequencer supports the [PBus protocol for communicating with switchers](#). This requires a Media Sequencer version 5.0 or higher. When clicked, a new browser tab opens with the configuration application for communicating with the switcher.
- **GH ImEx Staging Config** button: Available if the Media Sequencer supports image staging to Graphic Hub. This requires a Media Sequencer version 5.0 or higher. When clicked, a new browser tab opens with the [configuration application for the ImEx service](#). When this service is in use - all images in the active playlist originating from HTTP resources are automatically transferred to the Graphic Hub. The transfer status

is shown on top of the images in the Media column, where the status starts at 0% and counting up. When the status disappears, the image is transferred to the Graphic Hub. This reduced the delay when the image is played out on air. On a take, it still has to be transferred from the Graphic Hub to the Viz Engine, but this operation is usually quicker than loading it from an arbitrary HTTP resource.

✓ **Tip:**
To reduce the delay even more, remember to initialize the show containing the image. This will make the Viz Engine load the image from Graphic Hub into the memory.

3.3.2 Profiles Tab

Settings > Profiles

Use the Profiles tab to individually configure Profiles, Channels, Viz Engine handlers and Viz Video handlers, as well as easily configure video walls.

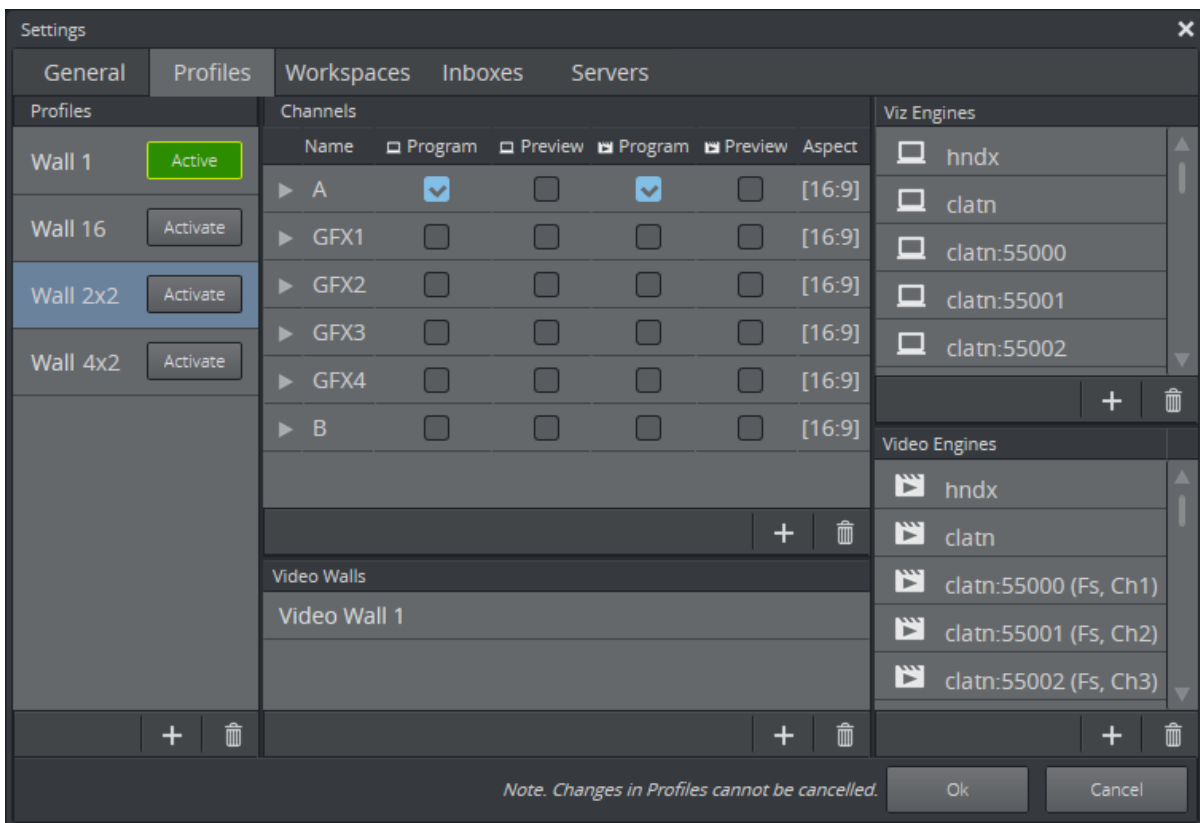

Profiles

The Profiles tab in Viz Multiplay works in much the same way as profile configuration in Viz Trio and Viz Pilot. It also uses the same data as Viz Trio, so changes made via either application are reflected in both.

Note:
Profile changes cannot be canceled.

Activate/deactivate profiles using the buttons in the Profiles list.

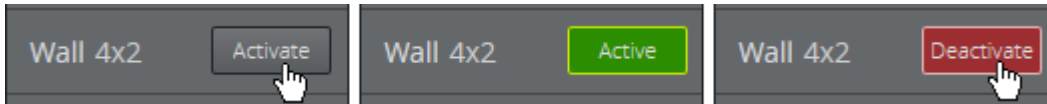

Note:
Always set the Active Profile for a show in Viz Multiplay. If a show is activated by a Viz Trio client, then it will be deactivated if that Viz Trio client shuts down, and Viz Multiplay will lose its active profile.

Note:
Renaming an active profile (from Viz Trio or Viz Multiplay) automatically deactivates the profile. Go back to **Settings** > **Profiles Tab** and click the Activate button for the profile again.

For more information see the section [Preparing Channels and Shows](#).

Channels

When elements are added to the channels in the [Media Pane](#), the channel name is reflected in the Viz Trio page list.

However, in Viz Trio, you can also specifically assign elements to channels. If an element is assigned to a channel name that is not present in the active profile, then that element will not be visible in Viz Multiplay. The element can also be invisible if the element's channel is hidden in the active workspace.

Elements that are assigned to the [PROGRAM] channel will be displayed in the channel set to viz/video program in the active profile in Viz Multiplay, regardless of that channel's name.

Note:
Terminology: "Main channel" in Viz Multiplay refers to the main channel of a video wall, while [PROGRAM] refers to the program channel of the profile.

For more information see the section [Preparing Channels and Shows](#).

Video Wall Setup

In addition to manually creating profiles and channels, you can also setup a new video wall using the Video Wall Setup tool.

Open the [Video Wall Setup Tool](#) tool by clicking on the **Add button at the bottom of the Video Walls pane**.

Status

The status of the handlers is shown by their icons. The status is refreshed when either the Media Sequencer needs to refresh them, or the user opens a handler editor. Hover over a handler to see the error message.

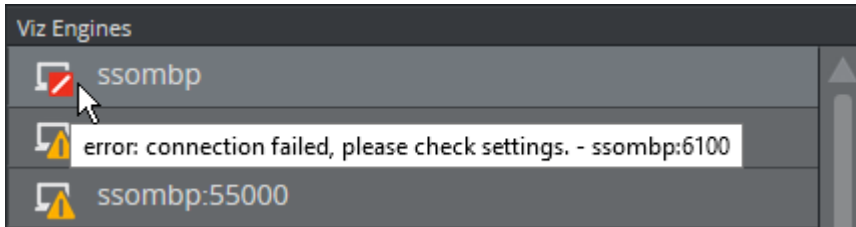

3.3.3 Workspaces Tab

Settings > Workspaces

Use this tab to create Workspaces, which define the set of channels that are hidden from view for each type of user.

Defining several workspaces allows different users to have access to different channels. For example, an operator in the control room may have access to all channels, whereas a presenter in the studio can just see the channels that they want to control.

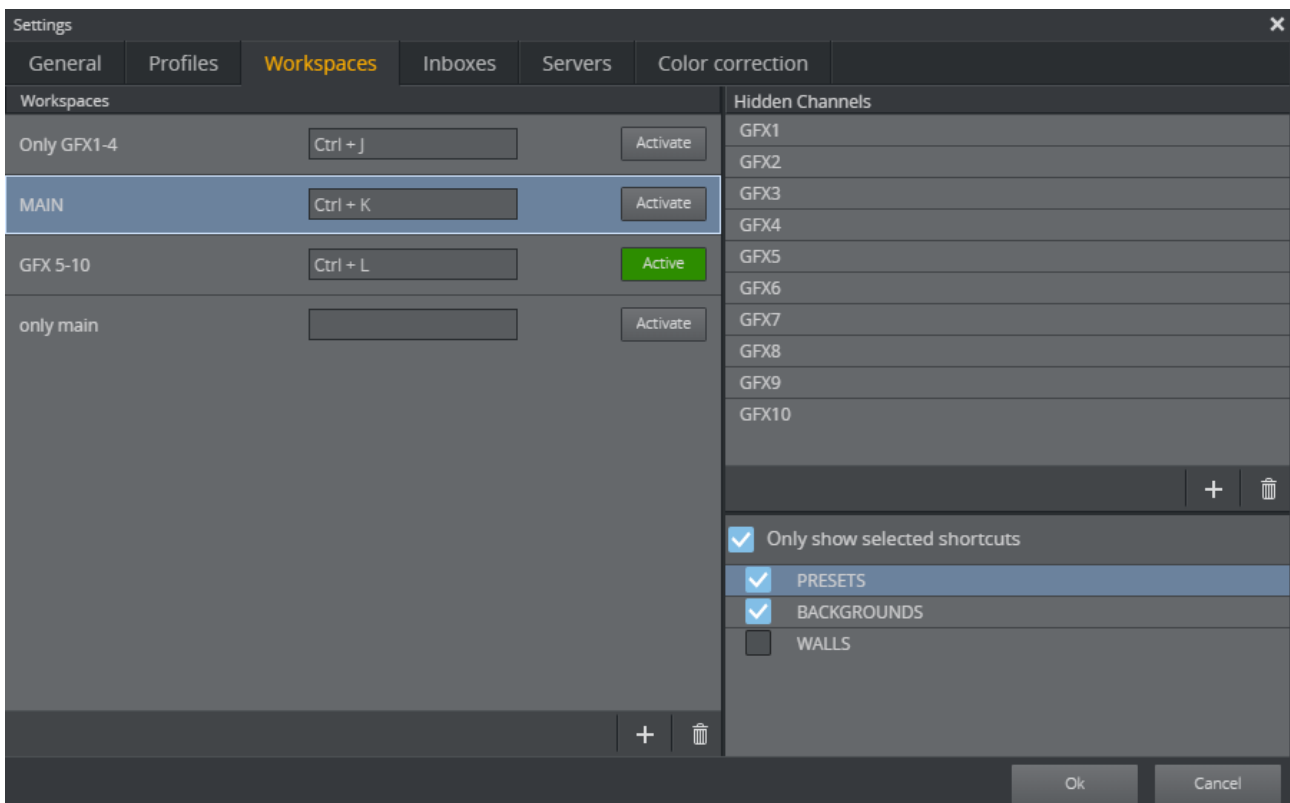

To Create a New Workspace

1. In the **Workspaces** pane on the left, click **Add (+)**, and give your new workspace a name.
2. In the **Hidden Channels** pane on the right, click **Add (+)** and type the name of the channel that you want to be hidden in this workspace.

✓ **Tip:** Alternatively, hide multiple channels with a single click. See the [Hide channel context menu](#) section below.

3. Set the active workspace for this user by clicking the **Activate** button.

Sharing Armed and Program Status with Workspaces

The status of the **Armed** column is shared according to the workspace. So users with the same workspace will see the same armed content.

In contrast, the **Program** column is a global resource, which always shows what is currently on air in each channel. All Multiplay clients have a synchronized view of what is playing on air, independent of which user triggers it.

Hide channel context menu

The Hidden Channels panel has a context menu that allows you to hide multiple channels. Hide channels based on their type (GFX or Main channels) or on the video walls they are associated with.

✓ **Tip:** Right-click the Hidden Channels panel to open the hide channel context menu.

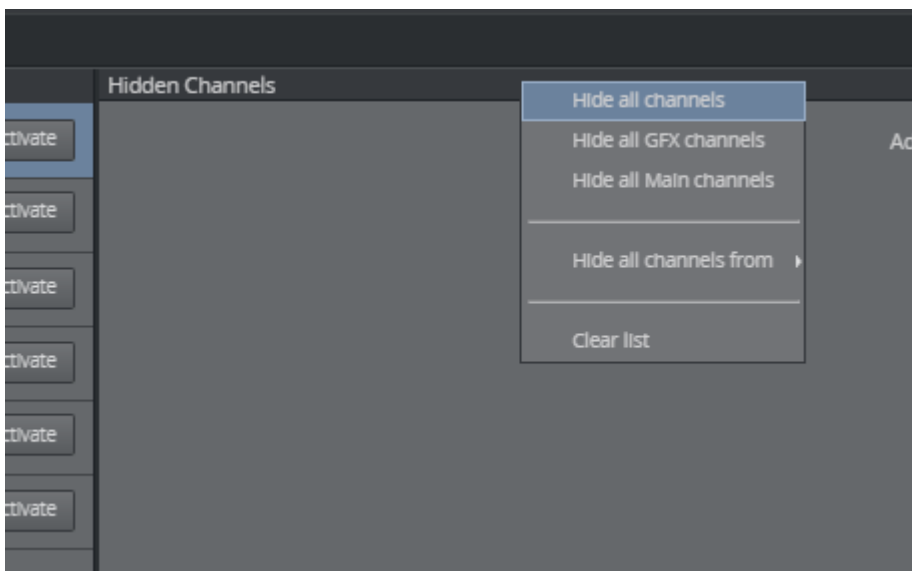

The context menu has the following options:

- **Hide all channels:** Hides all channels in all profiles
- **Hide all GFX channels:** Hides all GFX channels only
- **Hide all Main channels:** Hides all Main channels only
- **Hide all channels from:** Select a video wall to hide its associated channels
- **Clear list:** Click to clear the list of hidden channels.

Set keyboard shortcut per workspace

Switch workspaces with a custom keyboard shortcut. This allows you to switch workspaces without opening the Settings panel.

First, assign a keyboard shortcut with the following procedure:

1. Open the Settings window.
2. Click the Workspaces tab.
3. Type a shortcut into the field between the workspace and the Active button:

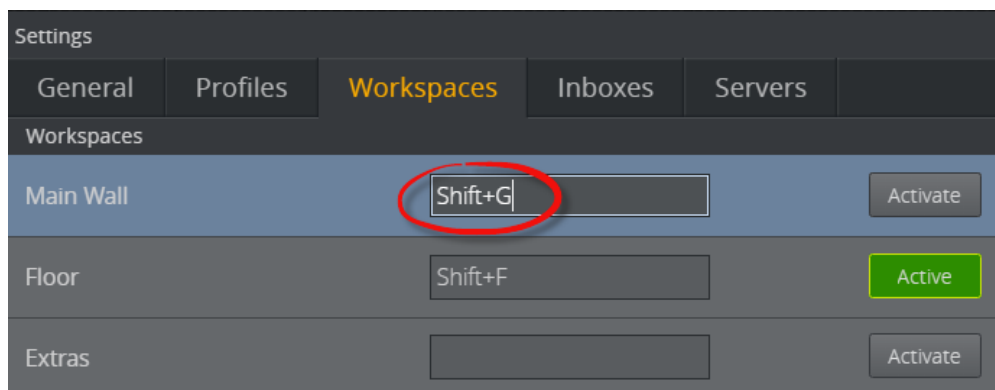

4. Click away from the field to confirm your choice.

✓ **Tip:**
Do not press **ENTER** to confirm your shortcut choice. Pressing **ENTER** will assign **ENTER** as a shortcut.

5. Click **OK**.

To use the shortcut:

Type the keyboard shortcuts at any time while viewing the main interface to switch between workspaces.

3.3.4 Inboxes Tab

Settings > Inboxes

Inboxes are sources of content that are always available as an **Inbox Tab** in the **Sources Pane**. You can configure multiple inboxes.

Any show on the Media Sequencer can be used as an inbox.

Note:
The inboxes you configure are global, so they will be available in all shows.

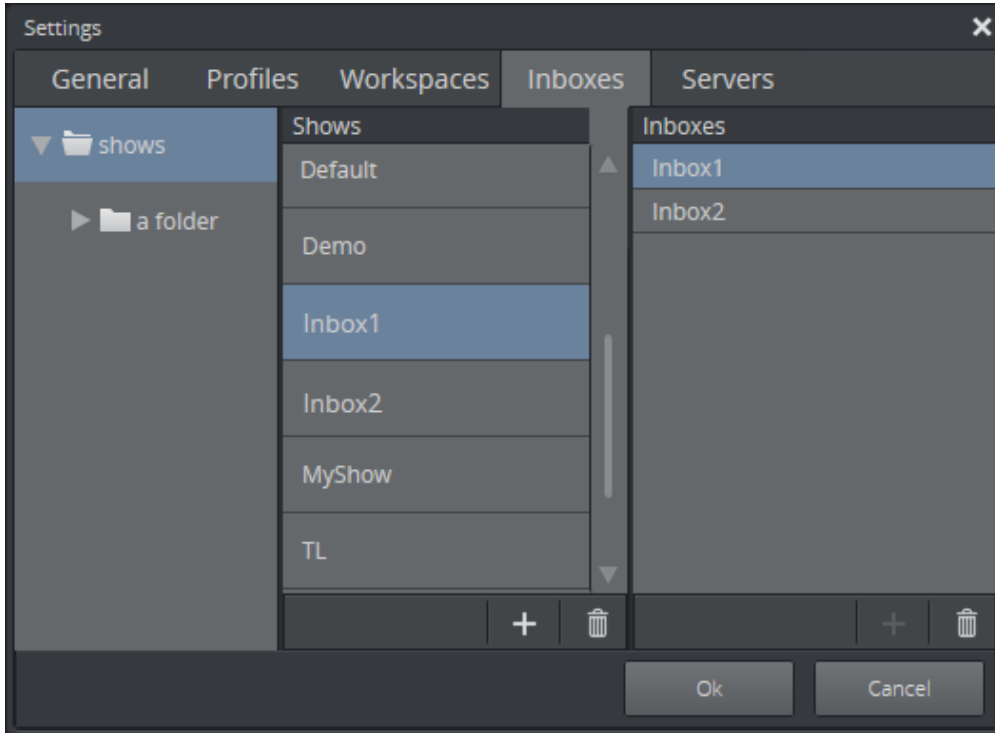

To **configure** a show as an inbox, drag the show from the Shows list to the Inboxes list, it will then appear as an **Inbox Tab** in the **Sources Pane**, as in the image below. Any content added to this show will be available as an Inbox tab, and can be dragged to a channel.

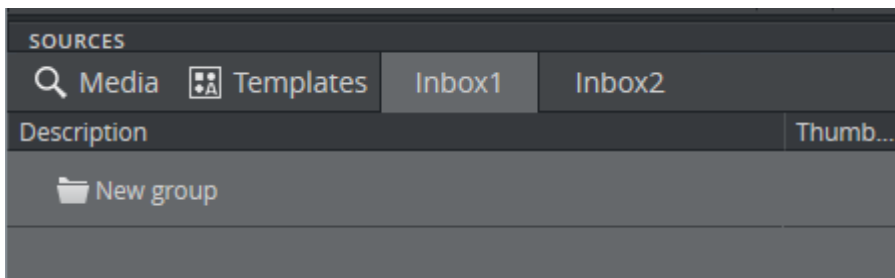

3.3.5 Servers Tab

Settings > Servers

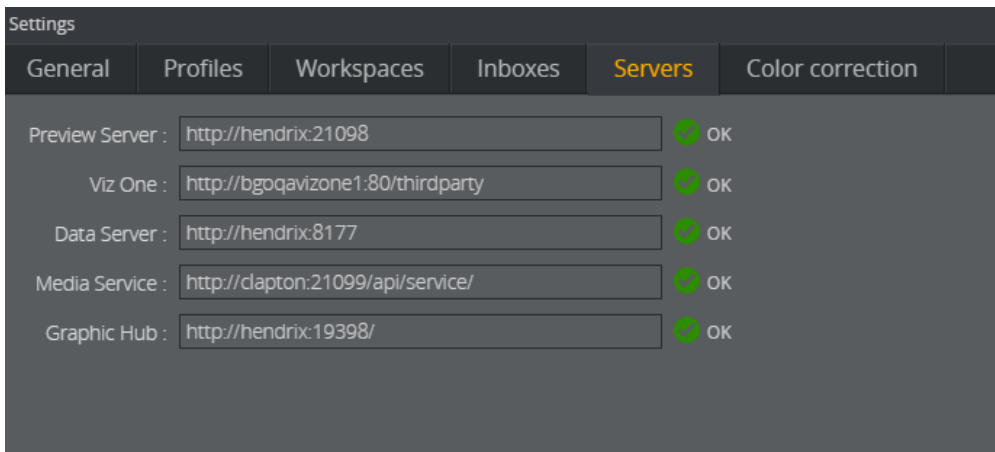

Workflow

Enter the URLs for the search providers that you want to use to search and preview media. The [Media Tab](#) search will then search in all sources and aggregate the results.

The search providers that you configure will appear in the [Media Search Filters](#) in the [Media Tab](#). You can search in a subset of these sources by deselecting some of them in the [Media Search Filters](#).

Note: Multiple search providers can be used. However, we do not recommend configuring a Viz One and a Media Service simultaneously.

Pilot Data Server

When a Pilot Data Server is configured, you get access to the Viz Pilot workflow. You can access Viz Pilot concepts and templates by dragging templates from the [Templates Tab](#) to your channels.

Server connection icons

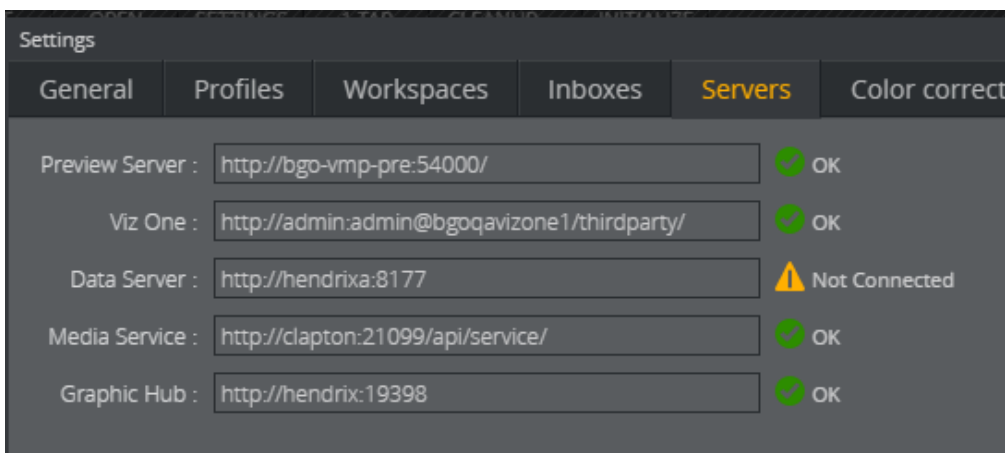

Icons next to the URL input boxes show the status of the connection to the server.

3.3.6 Color correction tab

Settings > Color correction

Correct colors for a particular monitor or group of monitors on a video wall.

Four steps to color correction:

- Select profiles and walls
- Map outputs to monitors
- Create a preset
- Adjust colors and other options

Select profiles and walls

Load the wall you want to edit by selecting the relevant profile and wall.

- Select the **Profile** and **Wall** from the drop-down menus:

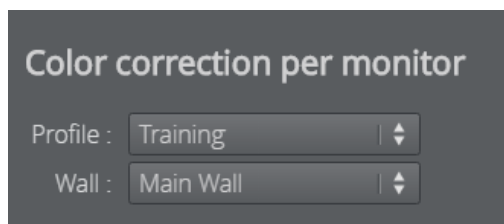

Map outputs to monitors

This step involves matching outputs (1) and with cubes (2). This is usually only done once.

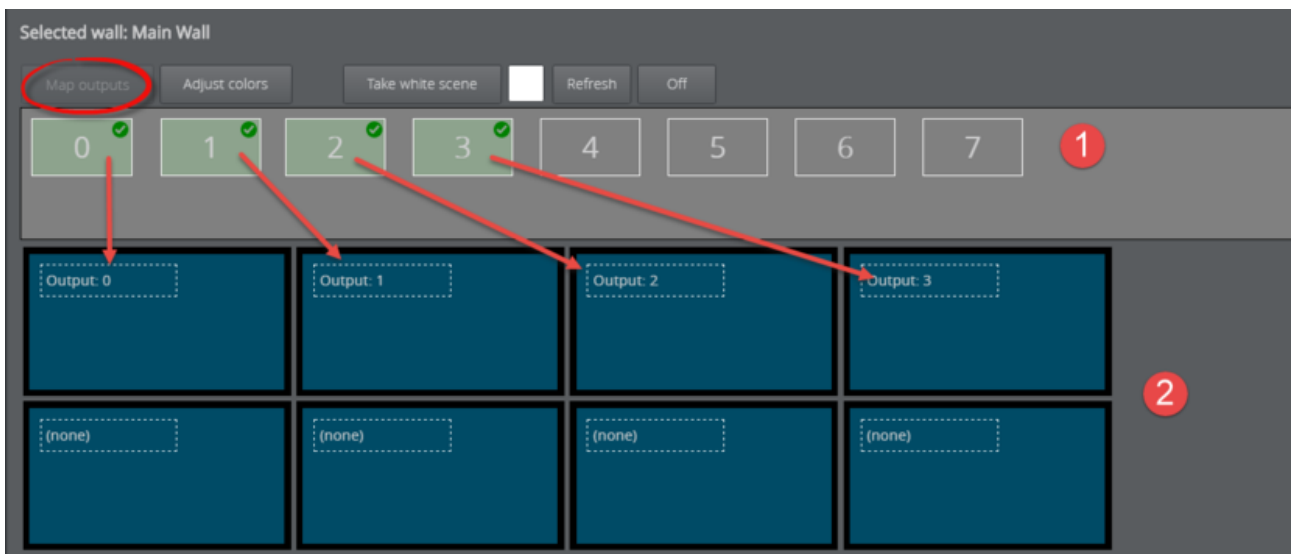

By cubes is meant the physical screens on your video wall. The task here is to drag outputs onto cubes to map them. Ideally, for the sake of organization, the cube layout should match the layout of the actual video wall.

Note:
The **Map outputs** view opens by default as long as outputs remain to be mapped. The Color correction tab always opens to the **Adjust colors** view after all outputs are mapped.

The easiest way to match outputs with screens is to load a white scene.

1. Click **Adjust color** -> **Take white scene**. All monitors on your video wall now display white.



2. Click an output.

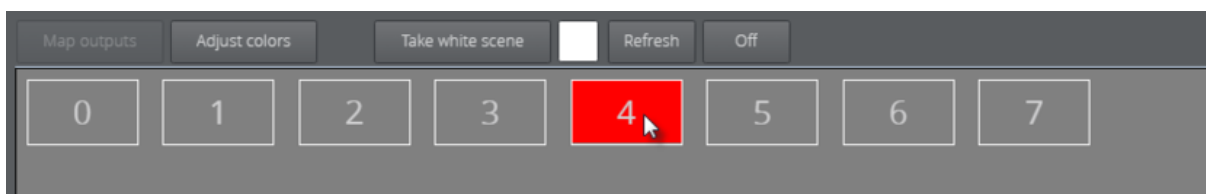

3. The video wall screen matching that output turns red. Here the bottom left screen corresponds to output four.

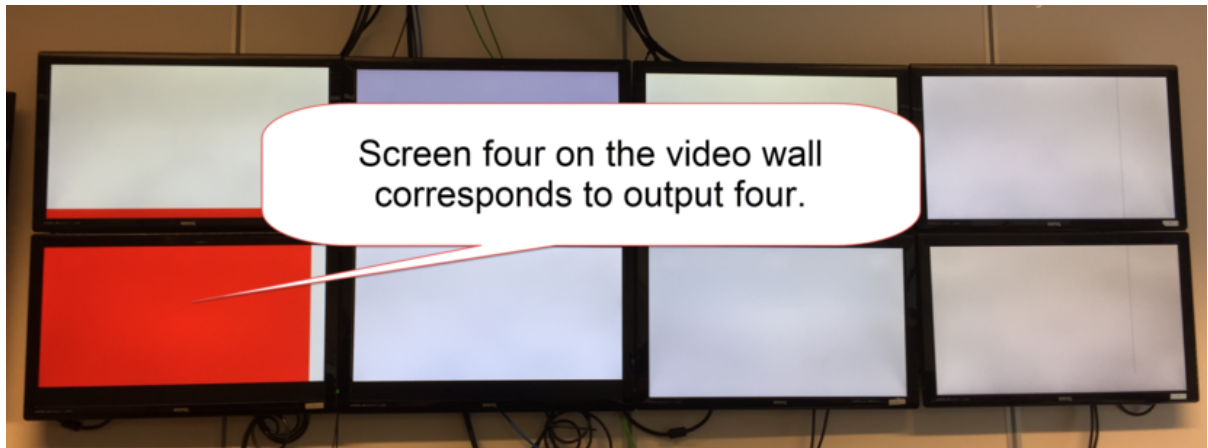

4. Then drag the output to the same position in the editor to map.

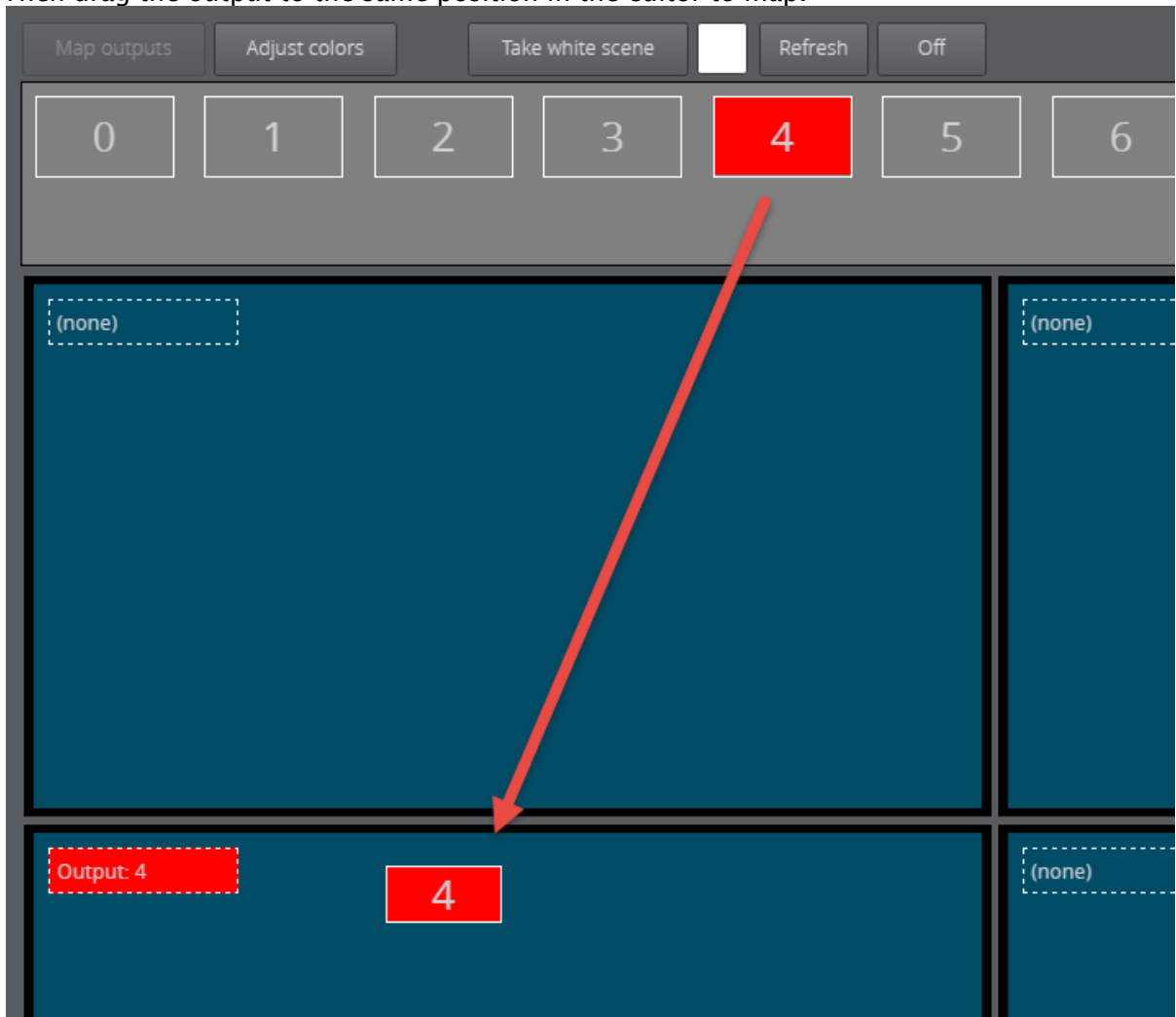

Note:

Remember that graphics channels feed content to the screens. Channels are mapped to screens in the output. So in the video wall above, output four is mapped to screen four, which could be receiving content from any GFX channel.

5. Map output 1.

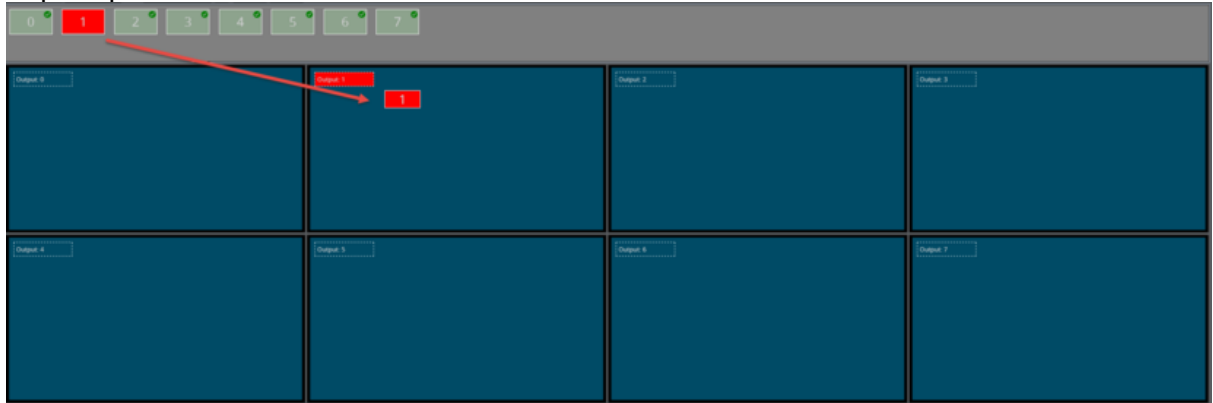
**Note:**

The output turns green and a check mark appears when it is successfully mapped to a monitor.

**Tip:**

Un-map an output by hovering the mouse over a mapped cube and clicking the red icon.

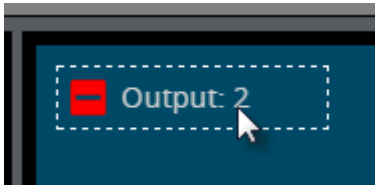

Create a preset

Create a color correction preset. This is useful in the case of multiple shows where each requires screens with different color intensity. A blue border appears around selected presets.

1. Click the **Adjust colors** button.

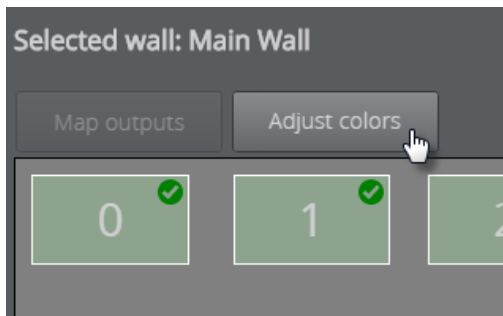

2. Click the **Add new color preset** button.

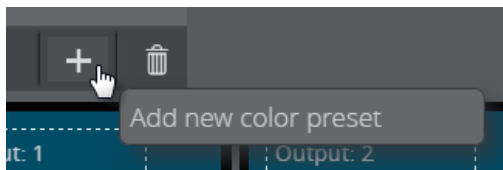

3. Give it a title and type **Enter**.

Adjust colors and other options

Adjust screen color on a monitor-by-monitor basis.

Note: Color corrections are only visible on the physical screen; they are not shown in VizMultiplay. Therefore, a physical video wall is recommended when adjusting color.

- Click a cube or screen to adjust its color.

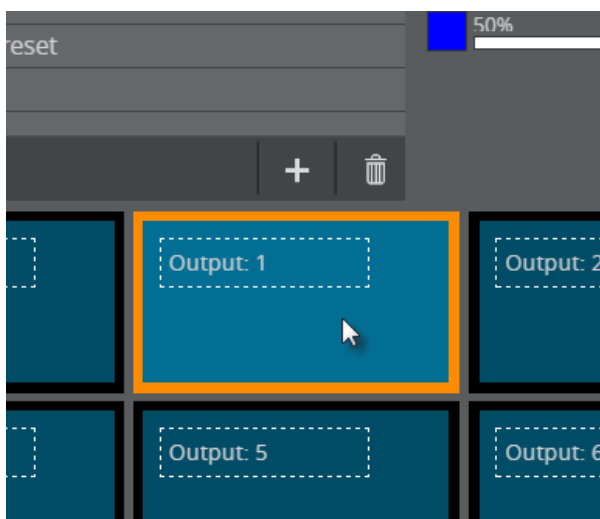

Adjust colors in the following five areas of the Adjust Colors view. Click **Ok** when finished to save the values for the selected preset.

Note:
Changes in color correction cannot be canceled.

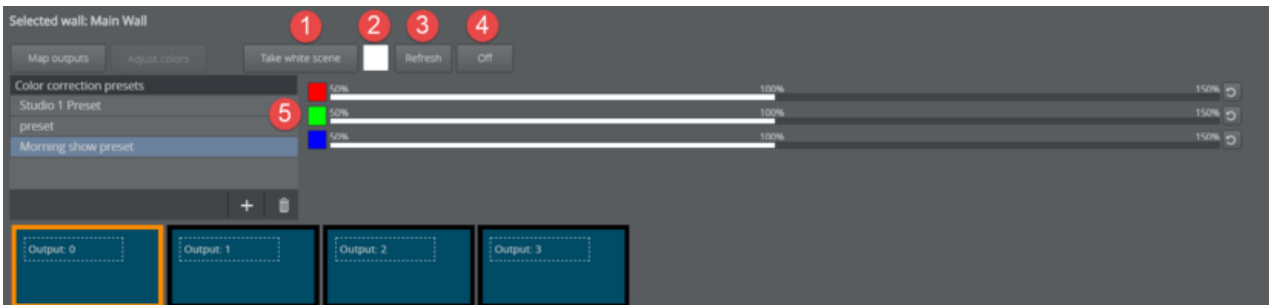

1. **Take white scene:** Take a completely white scene in the renderer.
2. **Select a color:** Alter the background color of the current screen.

Note:
The **Take white scene** button must be clicked to expose the color picker.

3. **Refresh:** Sent the configuration of entire preset (all monitors) to air.

Note:
It is also possible to send presets to air using commands in the media sequencer.

4. **Off:** Removes all currently-applied color corrections for the video wall.
5. **RGB sliders:** Click or drag along the slider to adjust the screen's RGB intensity. Select a value between 50 and 150 %, where 100% is default. For example, a 50% setting for red will deprive media in that screen of red.

Note:
The luminosity in the color block next to the slider brightens or dims to reflect changes in luminosity. View the monitor on the physical video wall to see the changes in real time.

Group screens

Apply the same color correction edits to multiple screens.

1. In **Adjust colors** view, hold down **CTRL** and click the screens you want to group together.



2. Right-click a screen and select **Group**.

3.4 Preparing Channels And Shows

The Viz Trio and Viz Multiplay clients share the data structure of the shows and the content inside the shows. They also share the profile configuration information.

This allows for workflows where different users can collaborate. For example, a Viz Trio client can be used to populate shows and prepare content, while a Viz Multiplay client is used for playout.

This section contains the following topics:

- [Profiles and Channels](#)
- [Shows and Playlists](#)

3.4.1 Profiles and Channels

Profiles are used to create different setups and can be defined with different program and preview channels. You can define channels which are mapped to Viz Engine machines for graphics rendering, or mapped to video devices for playout of video clips from video servers.

You can configure the profiles and channels from within Viz Trio, or from the [Profiles Tab](#) in Viz Multiplay. Changing the channel in Viz Trio will also change the channel in Viz Multiplay, and vice versa.

In Viz Multiplay, contents can be played out on multiple channels, with as many outputs as desired. Typically each channel would have multiple outputs and each output would be a single Viz Engine. In a typical video wall setup, Viz Multiplay will create one main channel with one Viz Engine output to the default Viz Engine port (6100) and a number of GFX channels with one Viz Engine output for graphics starting on port 55000 and one Viz Engine output for video.

Note:

It is possible to drag more outputs into the GFX channels to make content play out simultaneously on several screens.

For more information on Profile Configuration, see the [Viz Trio User Guide](#).

Note:

Adding videos to a graphics-only channel or graphics to a video-only channel, will result in the element not being played out correctly. Composite elements will only work on channels that support both graphics and video.

Delay payout

In a complex studio setup controlling multiple Viz Engines, it is sometimes desirable to adjust the timing of the output of the Viz Engines. It is possible to delay the payout in a Viz Engine:

1. Double-click one of the items in the Viz Engines (1) or Video Engines list or expand a channel and double click an Output (2).

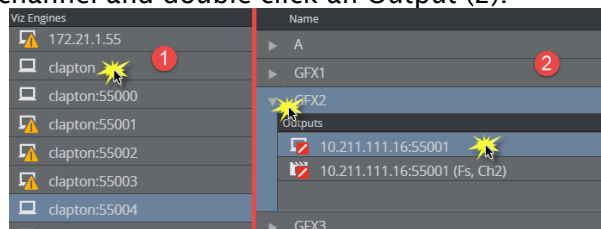

2. Enter a value in the Delay box.

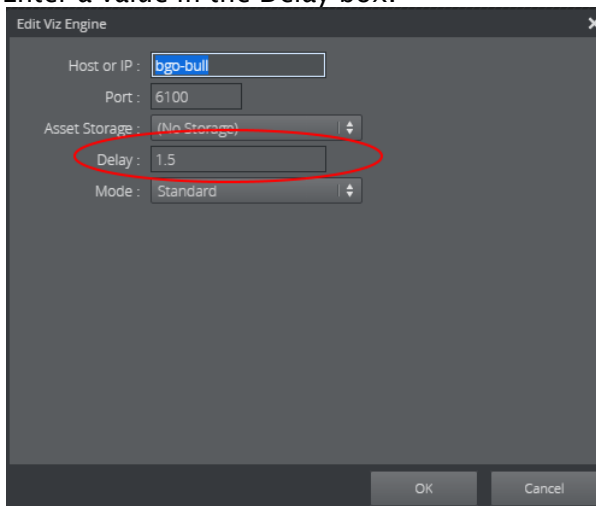

The payout is delayed for the specified number of seconds. The number can be a float, with fractions of seconds. The mechanism is not frame accurate.

Note:

The delay applies to all attempts to play out an element in the channel in Viz Multiplay, but also all other attempts to play out something in this channel, for example from Viz Trio or Mosart.

3.4.2 Shows and Playlists

Shows created in Viz Trio appear in the [Browse Shows Window](#) of Viz Multiplay.

Elements in the Viz Trio shows and playlists must be in **groups**. Note that a playlist inside a show is not accessible from the Browse window; instead it appears as a tab in the show.

Manual changes to the Viz Multiplay show are reflected immediately in the Viz Trio show and vice versa.

MOS connectivity from a Newsroom Control System works with Viz Multiplay in the same way as it does with Viz Trio.

To prepare a show using Viz Trio and Viz Multiplay

To create a new show and populate it with content using a Viz Trio client, and then play it out using Viz Multiplay:

1. In Viz Trio, create a new show.
2. Import scenes for the show.
3. Create pages from these scene templates.
4. Create one or more groups, and drag the pages into the groups.
Each group appears as a *story* in Viz Multiplay.
5. In Viz Trio, select the desired profile and activate the show in this profile.
6. In Viz Multiplay, open the show (go to **Open > Shows**).
Now Viz Multiplay has the same show activated in the same profile, and the content appears in the relevant channels.

To create a new show with Viz Multiplay

Shows can be created with Viz Multiplay, but graphical scenes will still have to be imported with Viz Trio. When a show is created with Viz Multiplay, three internal show playlists will also be created, one for shortcuts, one for graphics and one for video wall presets.

1. Open the Browse Shows Window by clicking the **Open** button.
2. Click the **Add (+)** button.
3. Name the new show.

To create a new show and play it out from Viz Multiplay:

1. In the [Show Pane](#), click **Add (+)** to open a new show.
2. Search for media in the various media sources.
3. Drag a media element to the desired channel for playout. The new element can be customized (see [Editing Graphics, Videos and Images](#)).

4 Using Viz Multiplay

This section describes how to work with Viz Multiplay.

- [Overview of the Interface](#)
- [Configuring Your Display](#)
- [Work with Shows, Playlists and Groups](#)
- [Move elements](#)
- [Sources Pane](#)
- [Arming and Taking Elements](#)
- [Shortcuts Bar](#)
- [Status and Logs](#)
- [Editing Graphics, Videos and Images](#)

4.1 Overview Of The Interface

The Viz Multiplay window has the following areas after a show is selected using the [Open](#) button:

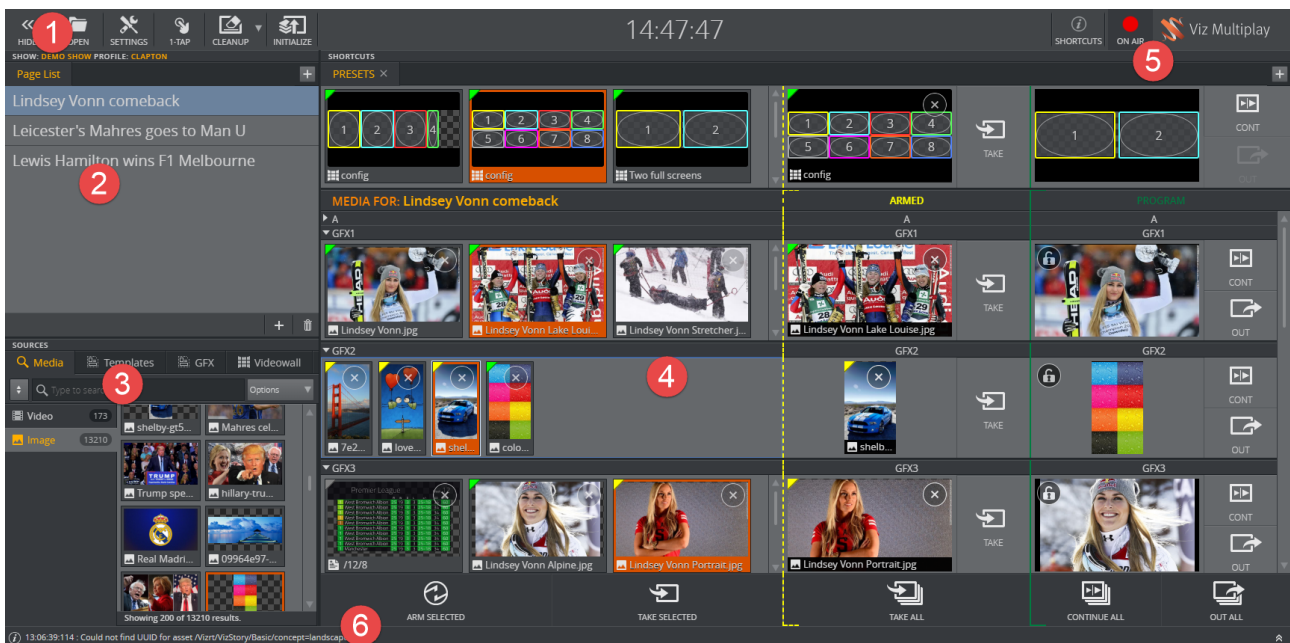

The window has the following main areas:

1. [Toolbar](#)
2. [Show Pane](#)
3. [Sources Pane](#), which includes:
 - [Media Tab](#)
 - [Inbox Tab](#)
 - [GFX Tab](#)
 - [Videowall Tab](#)
 - [Templates Tab](#)
4. [Media Pane](#), which includes
 - [Shortcuts Bar](#)

- [Media Column](#)
 - [Armed column](#)
 - [Program column](#)
 - [Action Bar](#)
5. [On Air Mode](#)
 6. [Status Bar](#)
-

4.2 Configuring Your Display

This section covers the following topics:

- [Layout Options](#)
- [Toolbar](#)
- [Hide Sources Pane and Show pane](#)
- [Settings](#)
- [On Air Mode](#)
- [1-Tap Mode](#)
- [Set up on a Tablet](#)
- [Resizing and collapsing channels](#)

4.2.1 Layout Options

- For a list of supported browsers, see [Setting up the Viz Multiplay Client](#).
- Chrome has features that can be useful when launching Viz Multiplay in a browser, see [Chrome Setup](#).
- Channels are collapsible individually and their size can be adjusted, see [Resizing and collapsing channels](#).
- Viz Multiplay can be run in portrait mode, which allows more space for displaying channels.

4.2.2 Toolbar

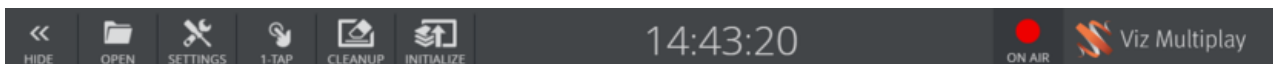

Configure how Viz Multiplay looks in your display from the tool bar using [Settings](#), [Hide Sources Pane and Show pane](#), and [1-Tap Mode](#).

Click on the Viz Multiplay logo for version information, as well as links to documentation and third party licenses.

4.2.3 Hide Sources Pane and Show pane



Click the Show/Hide button in the toolbar to toggle both the [Show Pane](#) and [Sources Pane](#) on/off.

4.2.4 Settings

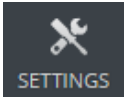

Open the [Viz Multiplay Settings](#) window from the tool bar.

- From the [General Tab](#) it is possible to change the thumbnail size, show/hide the status bar, and set whether to display a preview in the [Program](#) column when clips are taken to air.
- Use the [Profiles Tab](#) to individually configure Profiles, Channels, Viz Engine handlers and Viz Video handlers, as well as easily configure video walls.
- Use the [Workspaces Tab](#) to create [Workspaces](#), which define the set of channels that are hidden from view for each type of user.
- The [Inboxes Tab](#) allows setup of one or more global shows in which multiple users can ingest new elements (images, clips, graphics) simultaneously. These elements are available for the Viz Multiplay operator instantly.
- Use the [Servers Tab](#) to configure preview servers and MAM systems that help to search media quickly.

4.2.5 On Air Mode



Click this button to toggle between on and off air mode. In On Air Mode, the button turns red and the label is **ON AIR**. In off Air Mode, the button is grey and labeled **OFF AIR**. Certain functionality in the user interface related to sending items to air in On Air Mode is unavailable in Off Air Mode. This is in order to protect against accidentally sending elements to air while editing a show or channel.

The following panels and columns are hidden in Off Air Mode:

- The [Arm and Take Multiple Elements](#) Action Bar
- The [Armed](#) column
- The [Program](#) column

4.2.6 1-Tap Mode

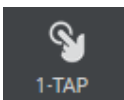

When 1-Tap mode is enabled, the [Armed](#) column is hidden and tapping an element or shortcut in

the Media column will take it directly to [Program](#). In this mode, elements can still be dragged between channels, or dragged to the program channel.

When 1-Tap is disabled, tap will arm an element. Tap in the Arm column to take it to Program. Drag elements to the preview pane to preview them.

4.2.7 Set up on a Tablet

As space is limited on a tablet, a compact layout is provided automatically. You can also consider using the following display settings:

- Hide the Status bar (See [Settings](#))
- [Hide Sources Pane and Show pane](#)
- Enable [1-Tap Mode](#)
- Adjust the Icon size (See [Settings](#))

4.2.8 Resizing and collapsing channels

Channels can be custom-sized, expanded by row or collapsed entirely.

- [Set custom channel size](#)
- [Resizing channels from the context menu](#)
- [Collapsing channels](#)

Set custom channel size

1. Hold down **ALT**.
2. Hover the mouse pointer over the top edge of a channel header until the cursor turns into a row separator (row resize cursor).

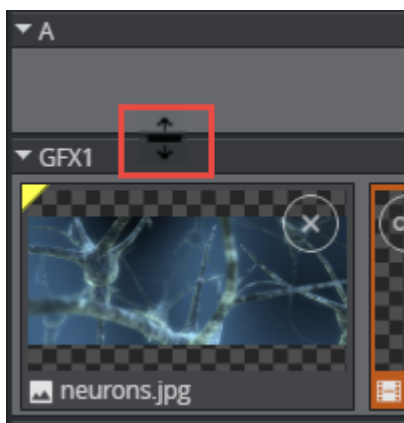

3. Drag the separator up or down as desired.

Resizing channels from the context menu

Expand channels by multiples of rows:

1. Right-click the channel header and select the **Set Height** menu item:



2. Select the desired row height.

Auto resize:

Select **Auto** to enable automatic creation of new channel rows when new items are added to a full row.

1. Click **Auto** from **Set Height**, as explained above.
2. The channel row is full of items, as shown here:

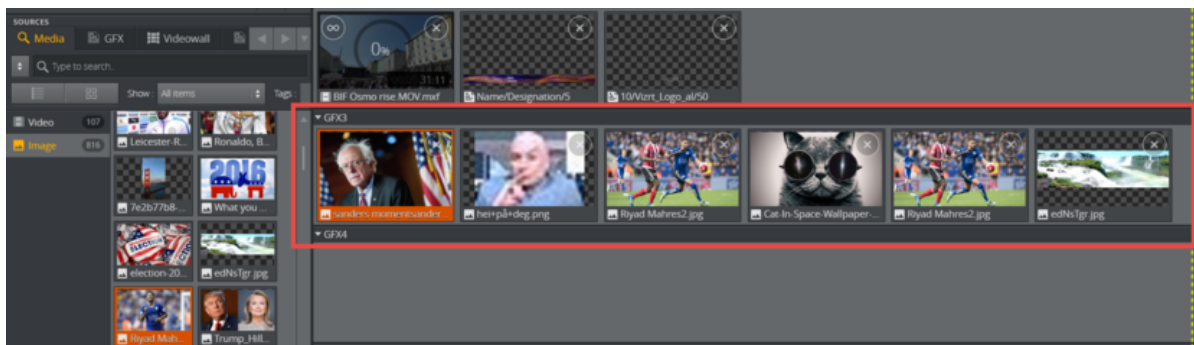

3. Drag an image from the **Media** tab into the row.

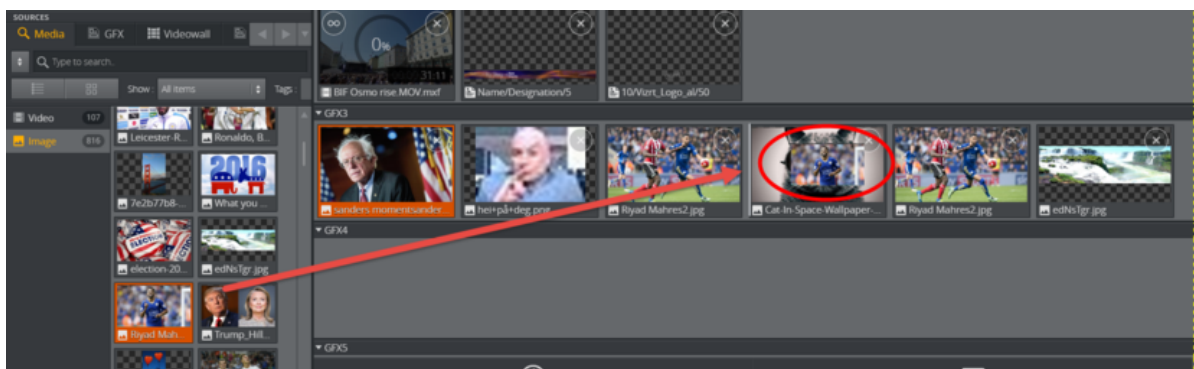

4. Two things happen: (1) The image appears in the row where it was dropped and (2) the last image in the row moves onto a new row below, which appeared because **Auto** was selected.

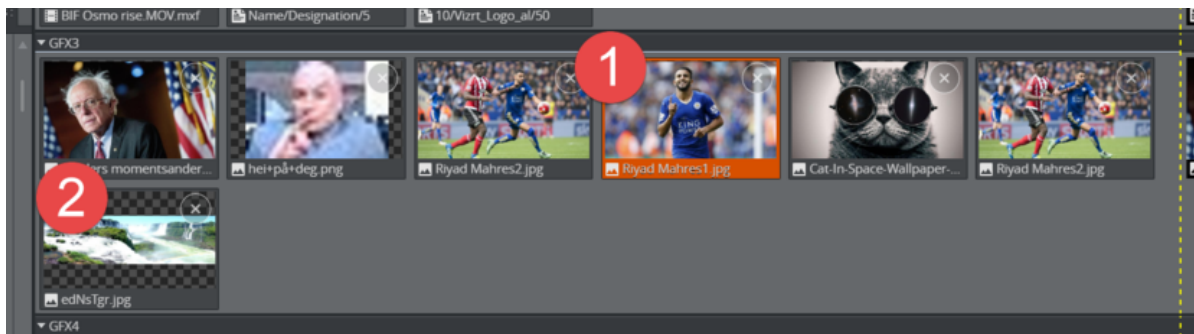

Collapsing channels

Collapse a single channel from view:

- Click the channel header to collapse individual channels.

Collapse or expand multiple channels from view:

1. Right-click a channel header.
2. Click **Collapse All** (or **Expand All** depending on the objective).

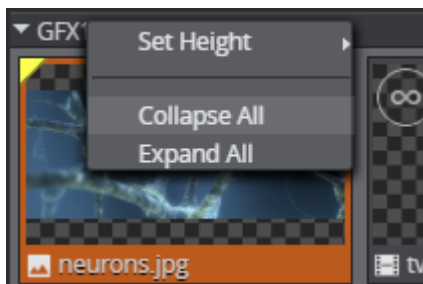

3. All channels in the Media Tab collapse:



✓ **Tip:**
Use the keyboard shortcuts **SHIFT+C** and **SHIFT+E** to collapse and expand all channels, respectively.

4.3 Importing Graphics

In a Vizrt system, graphics are created in Viz Artist and saved as scenes. The scenes are stored in Viz Graphic Hub. The scenes can contain control fields that the scene designer decides to expose to the user which contain default values. In order to play out a scene with custom control field data (eg. specifying a name and picture on a nameplate), this is the general process:

- In a control client (e.g. Viz Trio, Viz Pilot or Viz Multiplay) the user must browse to a scene in Viz Graphic Hub and *import* it.
- The control client stores its own representation of the graphical scene in its backend (in a Viz Pilot Database or in the Media Sequencer). They are stored as *templates*.
- In a daily context, a user opens the control client, select a template, fills in custom data in the control fields and stores a specific instance of the template as an *element*.
- The element can then be played out on a Viz Engine as a part of a broadcast, for instance, an overlay graphics with a name and title of a person being interviewed.

There are basically 3 ways of accessing graphics in Viz Multiplay:

1. Import graphics with [basic scene import](#) directly into Viz Multiplay. See below.
2. Use Viz Trio to import scenes and create pages usable within Viz Multiplay. See [Working with graphics](#).
3. Use a Viz Pilot system and access the graphics via templates and elements in the [Templates tab](#).

4.3.1 Basic scene import

In Viz Multiplay, it is possible to do basic scene import from the Graphic Hub directly into the GFX source tab, the Shortcuts tab or directly into any channel. To import a scene into the GFX source tab:

- Create a new group.
- Click the **Import graphics** button 
- In non-empty groups, right-click anywhere in the group and select **Import graphics** to start the import process:

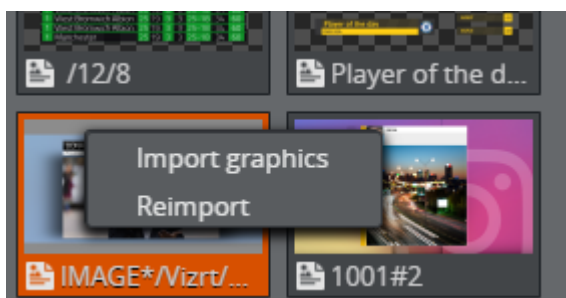

Now the search window appears. This window contains all the scenes created in Viz Artist. Search for the scene with free text and click **OK**.

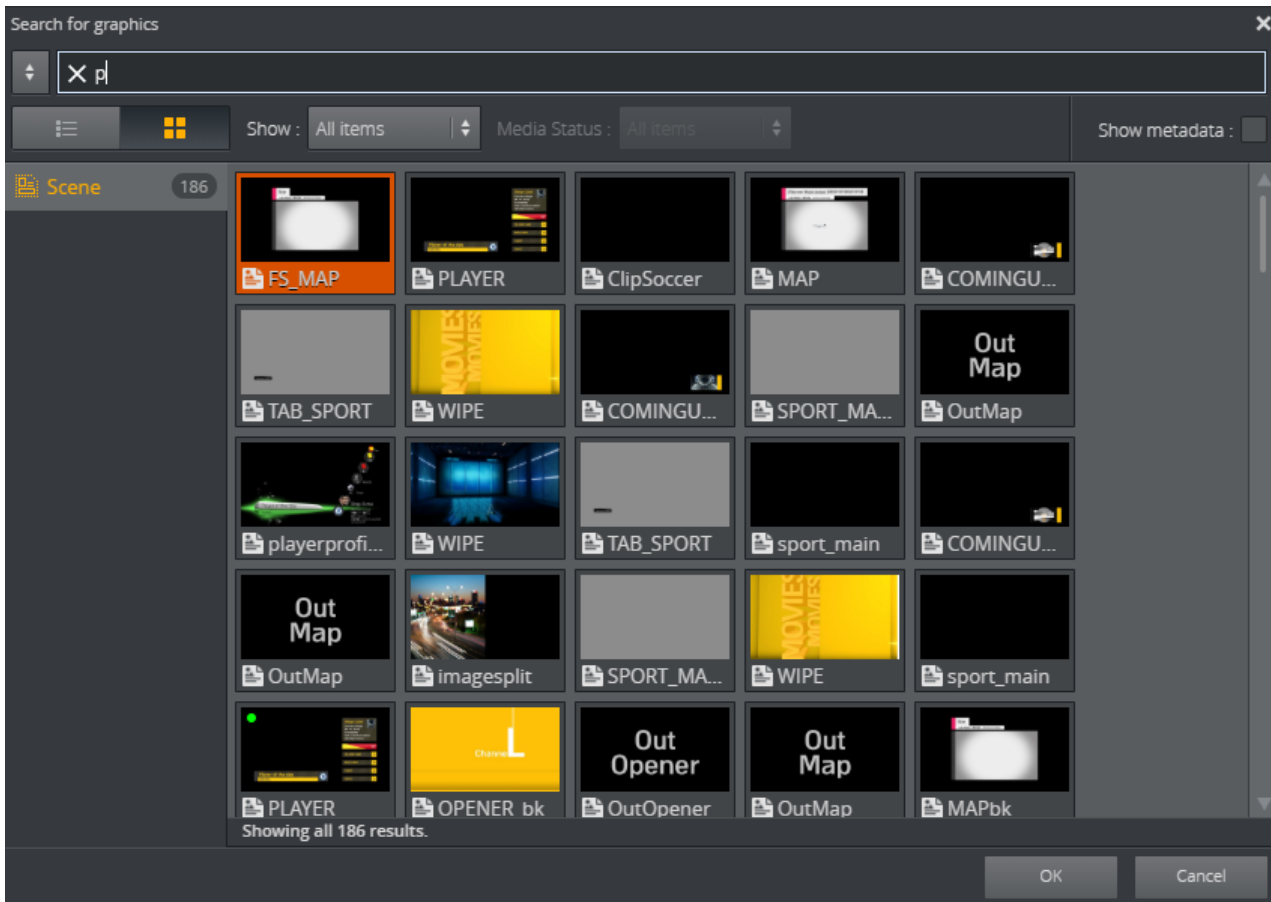

Scenes that are already imported into the currently opened show, are marked with a green dot:



Importing these scenes again is fully possible and meaningful if you, for instance, want to have several instances of this scene available in the GFX source tab with different default data. A good example is importing a nameplate graphics several times, and edit the different templates to contain names that are frequently used:

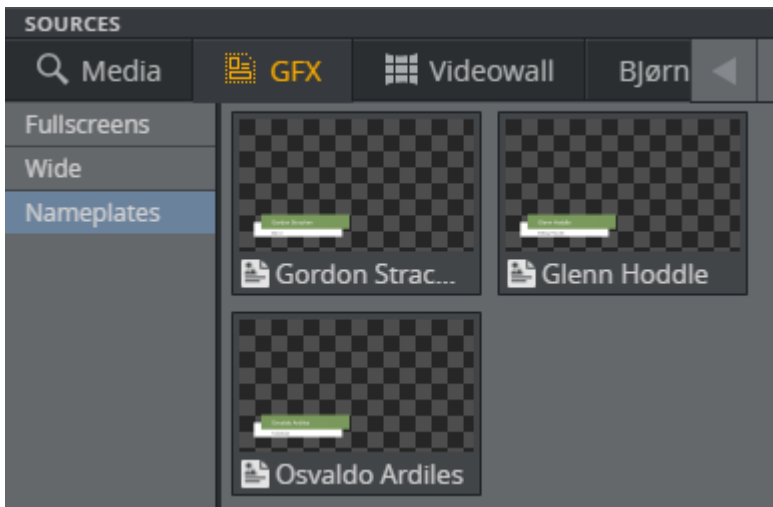

Reimport graphics

If the scene designer changes the scene, for instance, adds or removes a control field, the scene must be re-imported. This can be done by right-clicking any instance of the scene in the GUI (in a channel, in the Shortcuts panel or in the GFX source tab) and selecting **Reimport**:

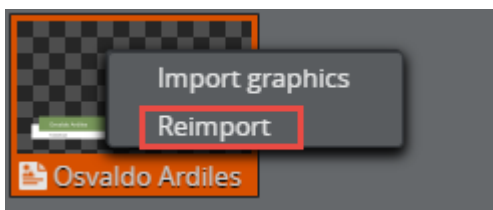

The result is that the scene is re-imported from Graphic Hub, and all elements based on this scene are now changed. The change is visible when editing the element in the Fill in form for graphics. If a control field is added, the elements based on the re-imported scene will contain default data specified by the scene designer in Viz Artist.

4.4 Work With Shows, Playlists And Groups

This section contains the following topics:

- [Open](#)
- [Browse Shows Window](#)
- [Show Pane](#)
- [Cleanup](#)
- [Initialize](#)

4.4.1 Open

Click the **Open** button on the [Toolbar](#) to open the [Browse Shows Window](#).

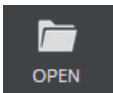

4.4.2 Browse Shows Window

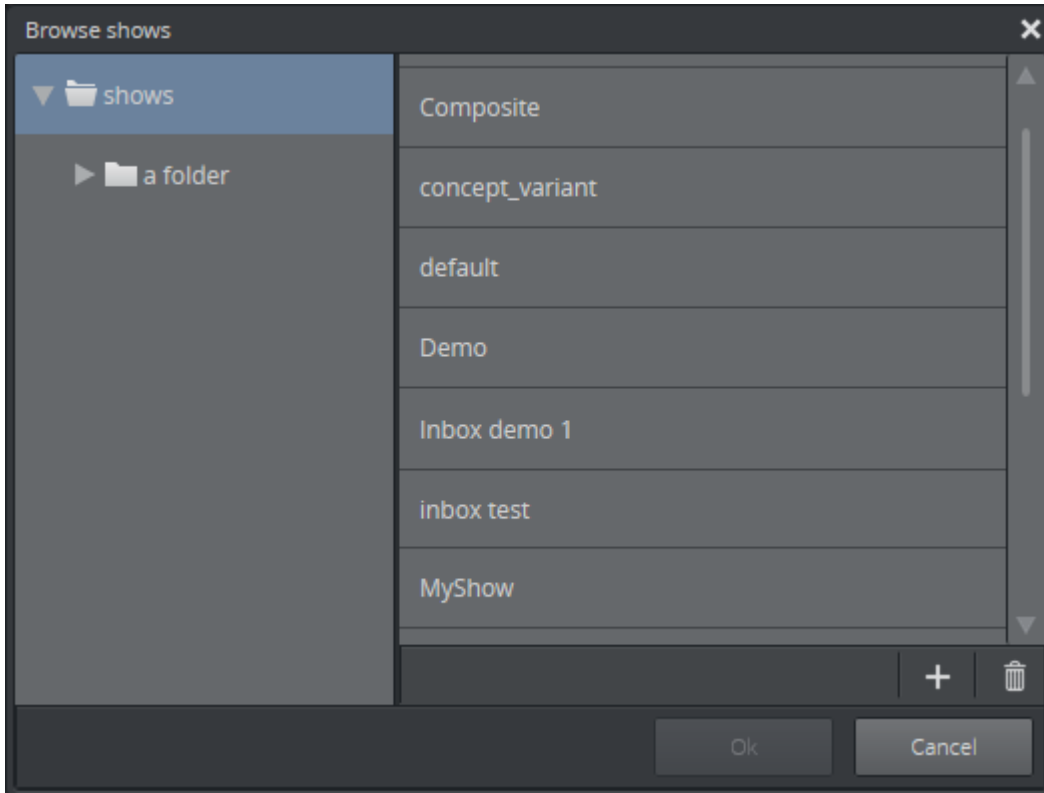

The Browse Shows window displays the shows that are available.

In this window, existing **shows** can be opened or deleted, or new shows can be created. Select a show, and it will open in the [Show Pane](#).

Shows can be **renamed** by selecting them and pressing **F2**.

4.4.3 Show Pane

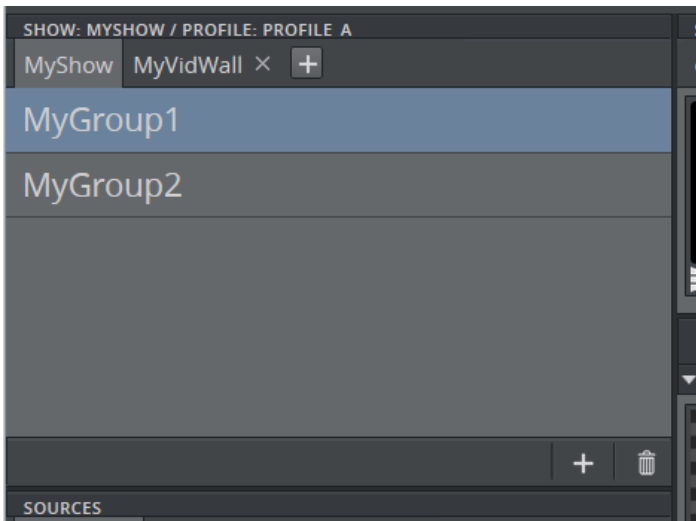

The Show pane at the top left of the main window displays the playlists and groups that are part of your show and connected to a certain profile. The first tab is the pagelist with the name of the show, and the other tabs are playlists.

Locating shows, playlists and groups in Multiplay

The first tab in the Show pane represents the show (e.g. *MyShow*), while the other tabs represent the playlists that are hosted by the show (e.g. *MyVidWall*),

Each tab contains Groups (e.g. *MyGroup1*, *MyGroup2*), and each group contains the elements for a story. When you select a group, the related media elements are loaded into the [Media Column](#).

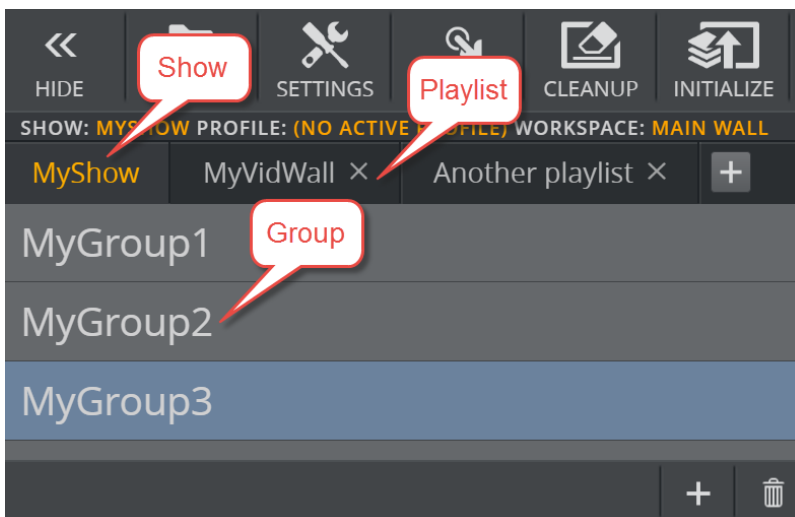

Add, Delete or Rename a Group

Add a new group to the bottom of the list of groups:

1. Click the **Add (+)** button at the bottom of the show pane.

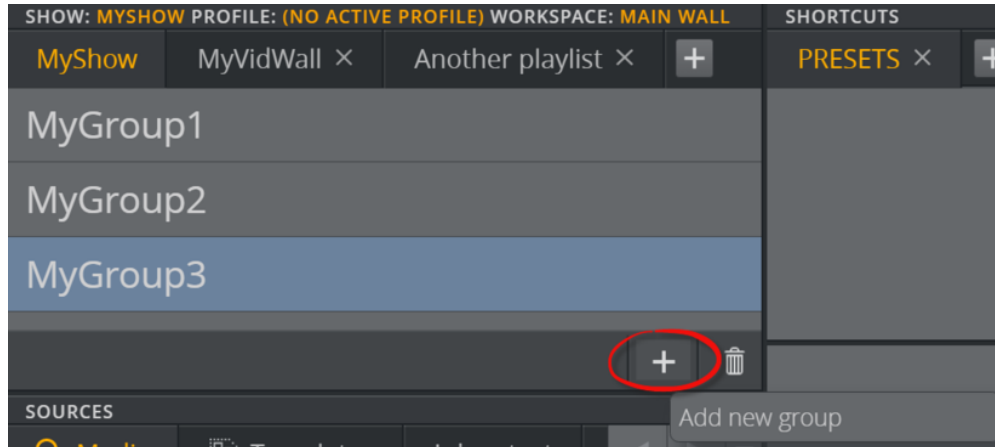

2. Give the group a title and press **ENTER**.

Insert a group into a specific spot in the list of groups:

1. Right-click a group and select **Insert new group** from the shortcut menu.

⚠ IMPORTANT!
The new group will be inserted above the group you right-click.

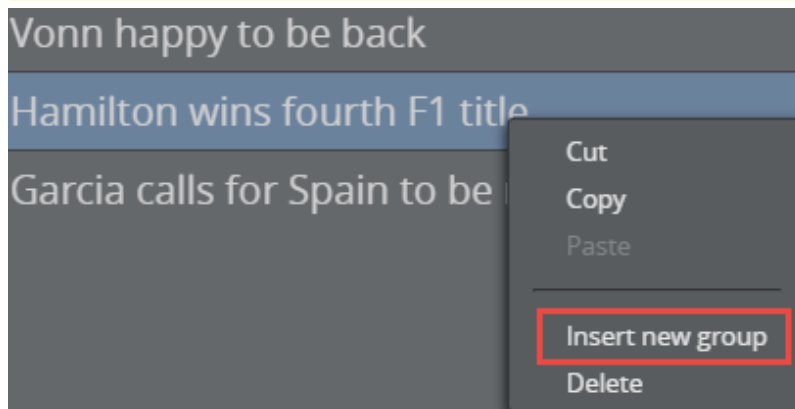

2. Give the new group a title and press **ENTER**.

Delete a group from the show pane:

1. Click the trash can icon at the bottom of the show pane.

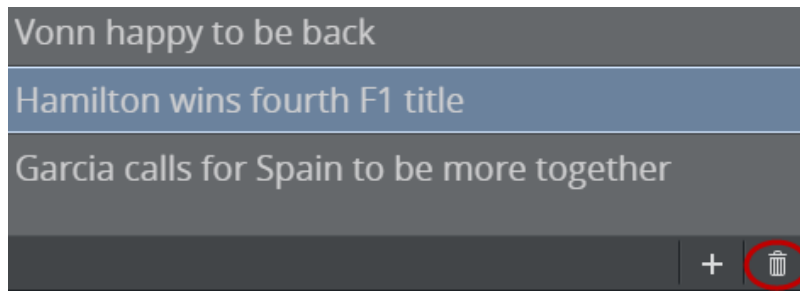

2. Click **Yes**.

✓ **Tip:** You can also delete a group by right-clicking a group and selecting **Delete** from the shortcut menu.

Rename a group:

1. Double-click a group.
2. Enter a new name.
3. Press **Enter**.

✓ **Tip:** Groups can also be created and modified using Viz Trio.

Move groups to other playlists in the show pane

Move groups between playlists in the Show pane. Move a group by dragging, with a copy/paste operation using standard Windows keyboard shortcuts or via a group's shortcut menu.

Example workflows:

Drag a group onto another playlist tab to move it (in this example, a group from the Rundown playlist is dragged onto the Local playlist tab).

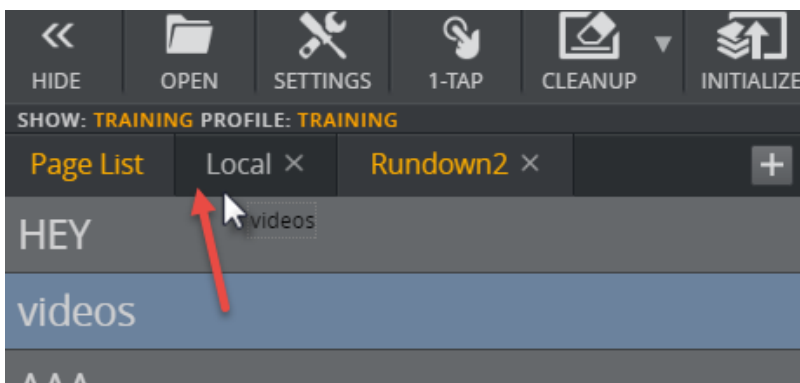

Move a group with copy/paste keyboard shortcuts.

1. Select a group and press **CTRL+C**.
2. Click the destination playlist.
3. Press **CTRL+V** to copy to the new playlist.

✓ **Tip:**
Copy/cut/paste groups via a group's shortcut menu.

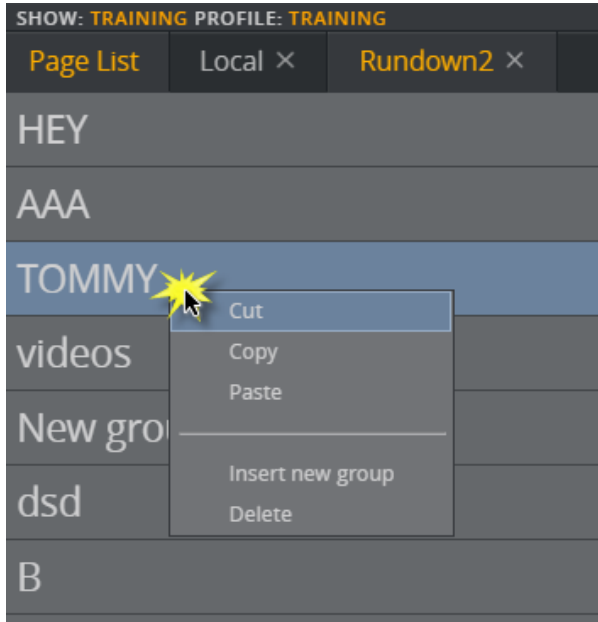

Add a New Playlist

1. Click the **Add (+)** button to create a new playlist or open an existing external playlist.

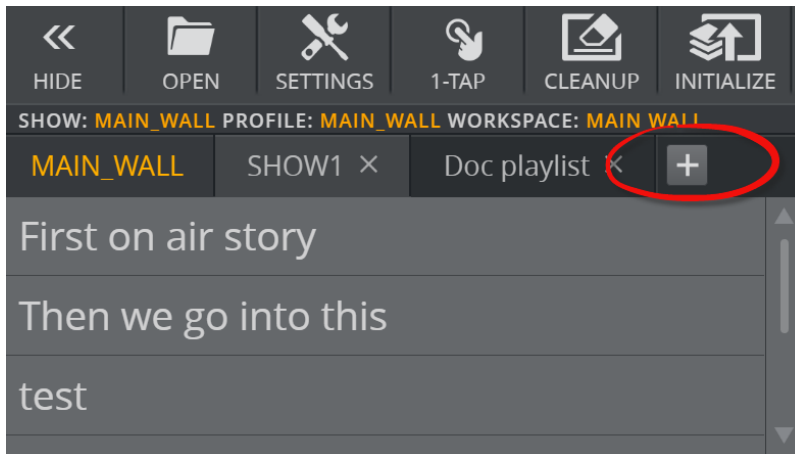

- a. **Create new playlist:** This playlist will be owned by the show. It will appear as a tab in the Show pane but will not be visible in the show/playlist directory tree.

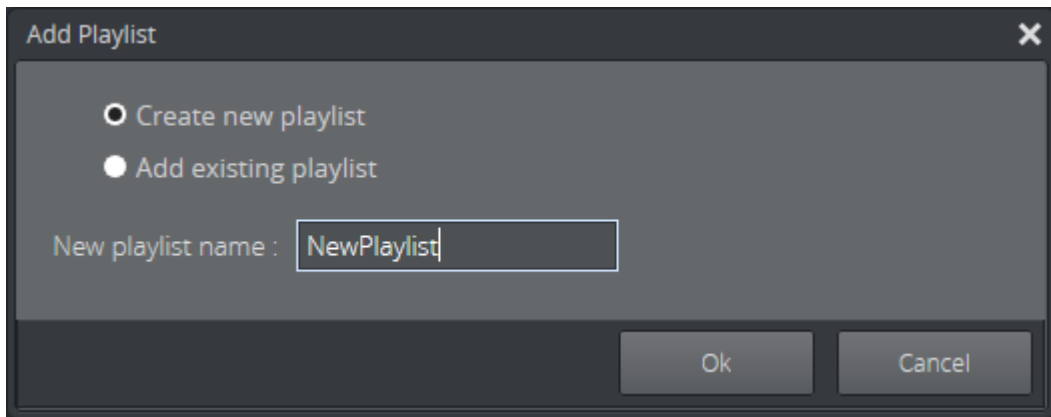

- b. **Add existing playlist:** Open existing playlists from Viz Pilot, or other newsroom systems (eg. MOS playlist).

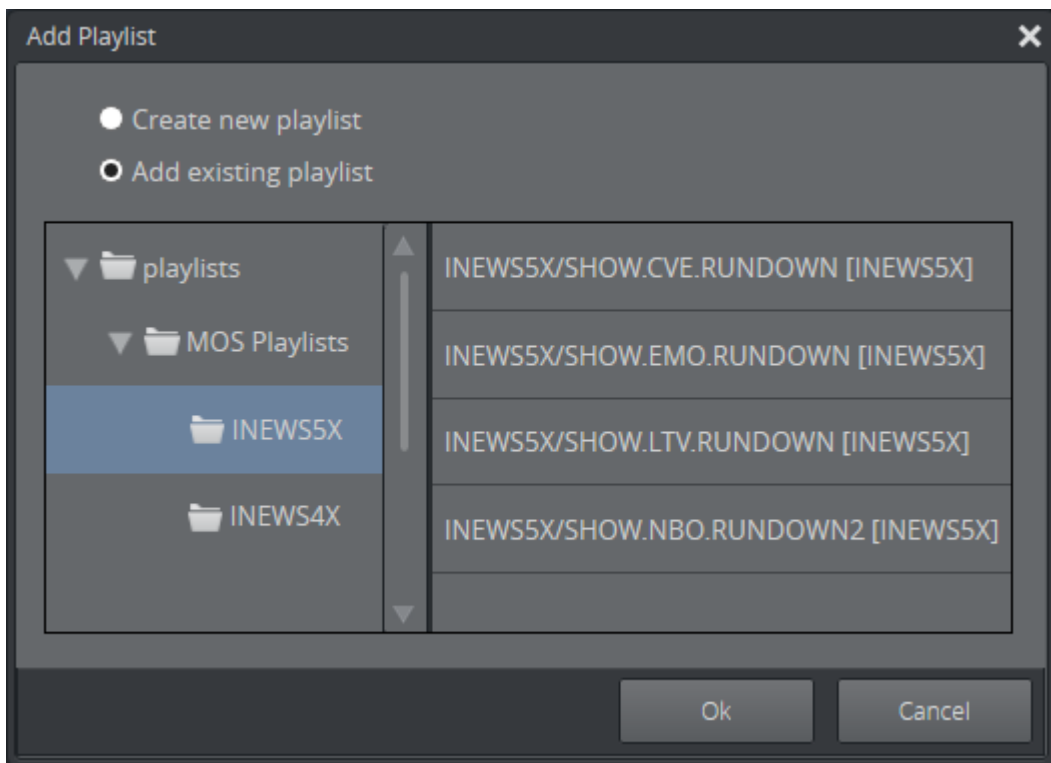

2. Click the **Close (X)** button to delete an internal playlist or remove the reference to an external playlist.
3. Click **Ok**.

✓ **Tip:**
Playlists can also be created and modified using Viz Trio.

Working with playlists

Rename a playlist

1. Double-click the playlist title.

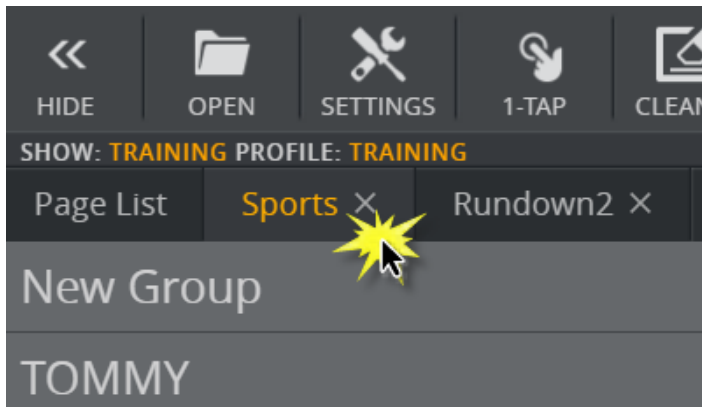

2. The title field becomes editable.

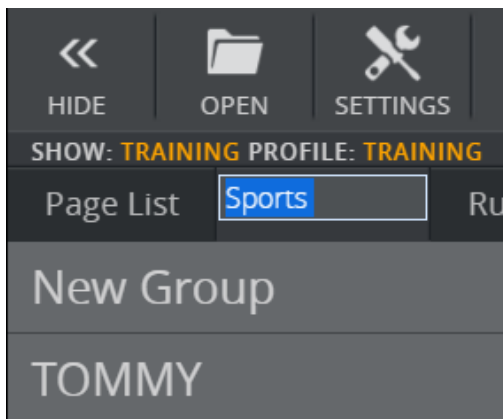

3. Enter a new title in the field and press **ENTER** to confirm the change.

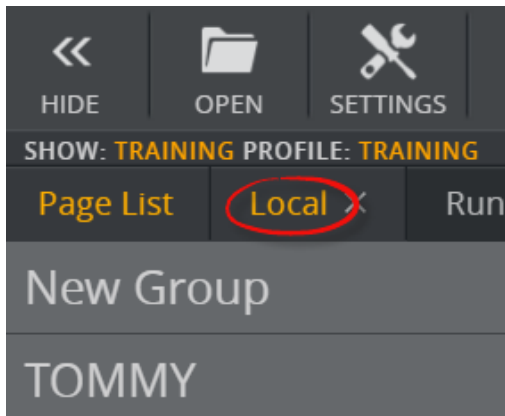

Reposition a playlist

1. Click and drag the playlist to the desired position in the top menu.

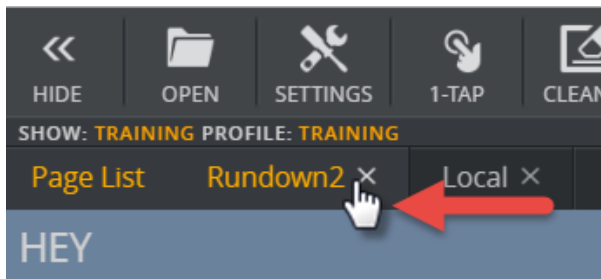
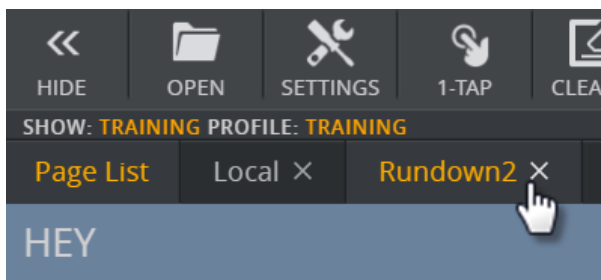

4.4.4 Cleanup

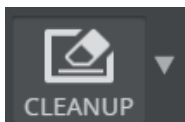

Cleanup clears all loaded graphics from memory on the renderer(s) for the profile currently in use. It should be used before initializing a new show or in order to re-initialize the same show into the renderer's memory.



Note:

Cleanup commands will affect all Viz Trio and Viz Multiplay clients that are connected to the same Media Sequencer, and using the same output profile.

- Clean up the renderer for **all** walls in a profile: Click the **Cleanup** button to clean up the renderer for all walls for the currently-active profile.

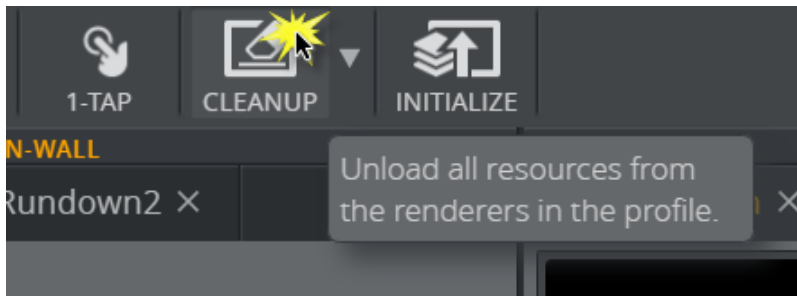

- Click **Yes** in the warning dialog that appears to clean up the renderer for **all** walls in a profile.

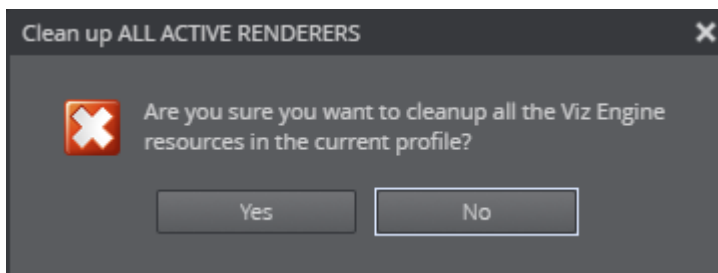

- Clean up the renderer for a particular wall in a profile: Click the downward-facing arrow in the cleanup button to expose a menu and select the wall you want to clean up.

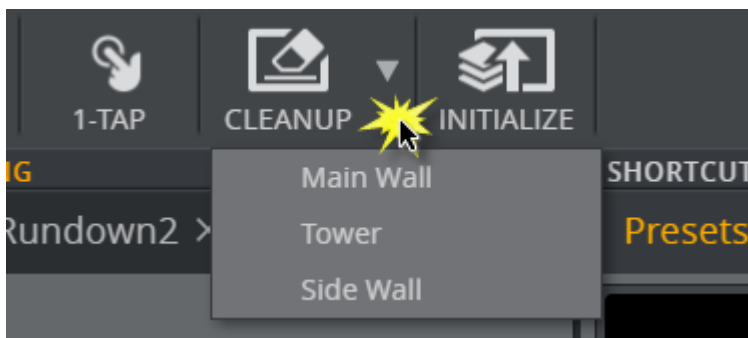

4.4.5 Initialize



The Initialize function works the same way as it does in Viz Trio. The Initialize button loads the current show's graphics into the Viz Engine memory. This operation makes sure that the element is played out instantly in a Take. The colored triangle in the top left corner of the elements in the Media pane indicates whether the resources are loaded on the renderer. Green is loaded, yellow is loading, and gray means unloaded. If the graphics is not loaded, it may take some time before the renderer plays the graphics when a Take operation is executed. Hold the mouse cursor over the Initialize button to see the total Loaded status for the show.

It is also possible to initialize single scenes by right-clicking the thumbnail and selecting **Initialize**.

Initialize does not refresh everything (i.e. it performs a load, not a reload, on the Viz Engine). If changes have been made to a scene that was already loaded, a [Cleanup](#) renderer command must be issued, and then an Initialize command. If single scenes should be reloaded from the Graphic Hub, right-click the thumbnail for the element and select **Reload Scene**.

**Note:**

Initialize will load resources into the memory of the Viz Engine. This might affect the frame rate of the rendering negatively. It is recommended to initialize graphics before the broadcast, or while something less resource demanding is playing on the engine.

4.5 Move Elements

You can move elements, i.e. images, videos, graphics or presets, between channels and columns, including the [Media Column](#), [Armed](#) and [Program](#) columns and the [Shortcuts Bar](#).

The options for moving elements change depending on whether Multiplay is off air or on air, and whether [1-Tap Mode](#) is enabled when on air.

- [Move elements in off air mode](#)
- [Moving elements in on air mode](#)

4.5.1 Move elements in off air mode

There are various ways to move elements in off air mode as described in the following sections.

Move elements by dragging

Drag an element from one channel to another:

This operation simply moves an element between channels.

- Click and element and drag it to a new channel.

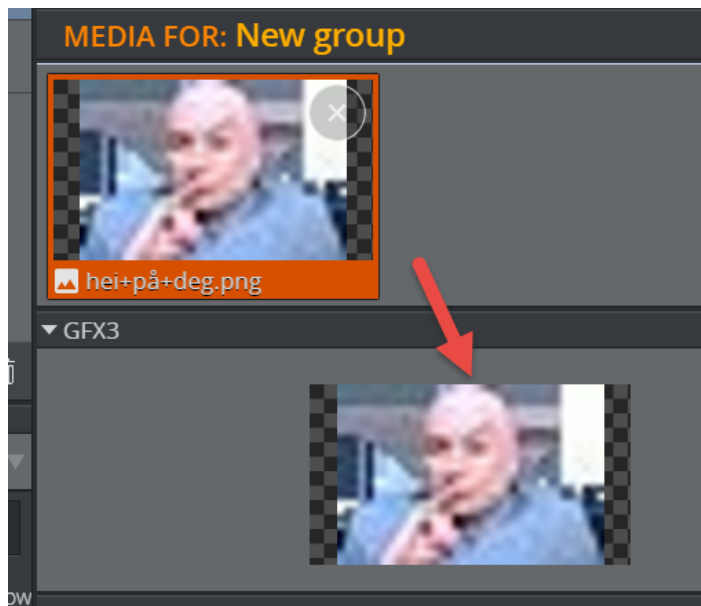

Drag an element from a channel to the Shortcuts Bar:

Dragging an element from a channel to the Shortcuts Bar will result in that element existing in both places.

- Drag an element into the [Shortcuts Bar](#) from a channel.

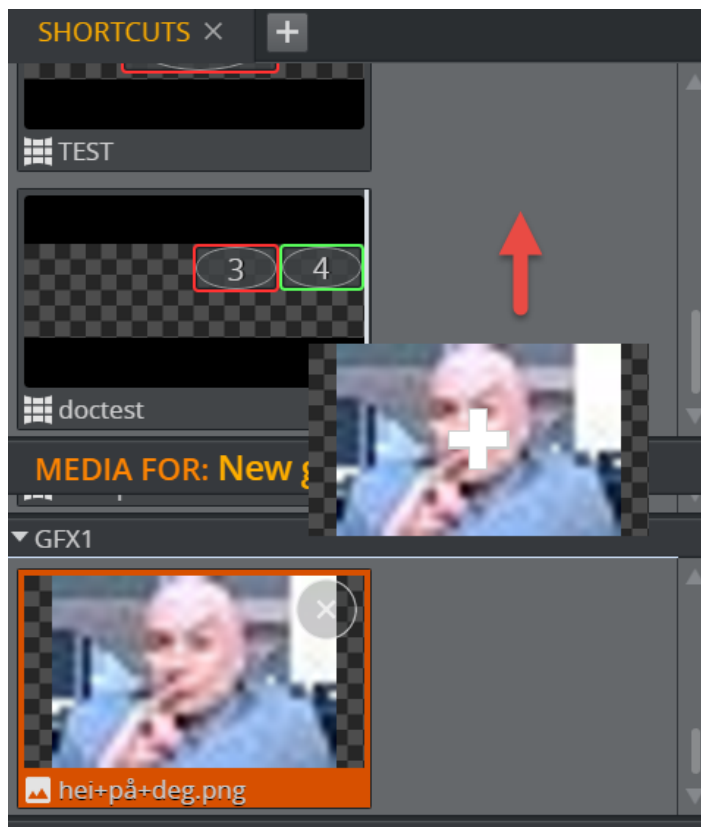

Note:
The plus (+) sign is a visual indication that the element will be copied, i.e. the drag operation will not delete it from its original location.

Make a copy of an element so it exists in two or more channels:

Copy an element to another channel.

1. Click and start to drag an element to another channel.
2. Press the **CTRL** key after you initiate your drag.
3. A plus (+) sign appears over the element, confirming that you wish to copy the element. This means it will remain in the channel you are dragging from and while also existing in its new location.

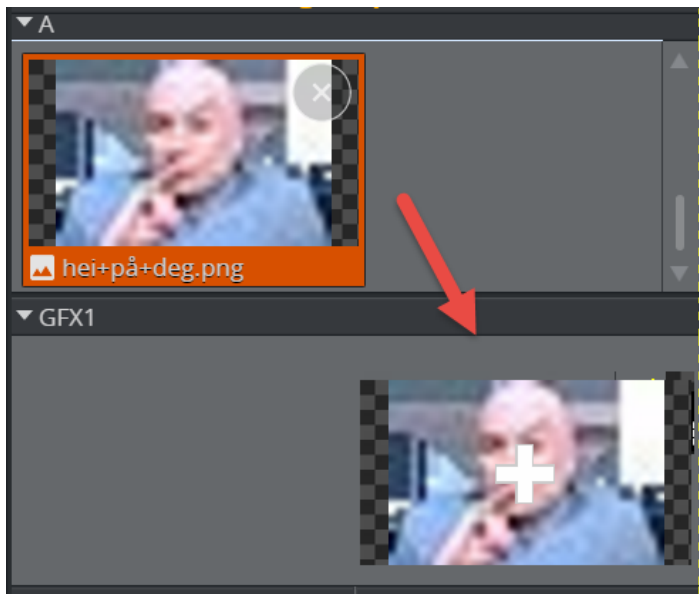

4. Drop the element in the desired channel.

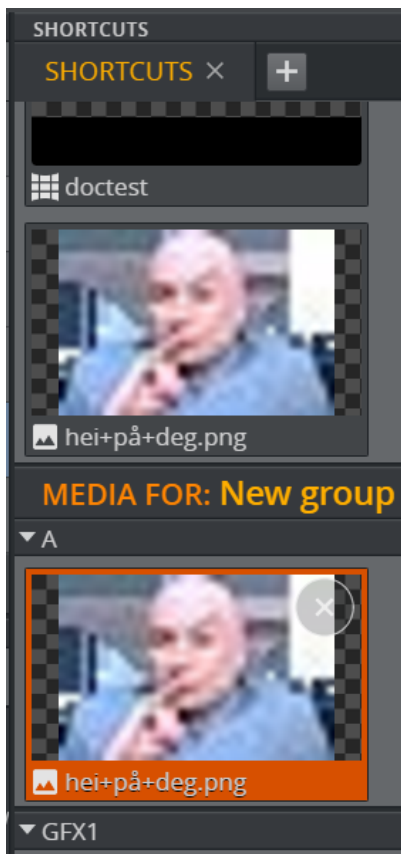

Move elements via the context menu

Move elements between channels or from a channel to the Shortcuts Bar either by copying or cutting them.

1. Right-click an element in a channel.
2. Select **Copy** or **Cut**.

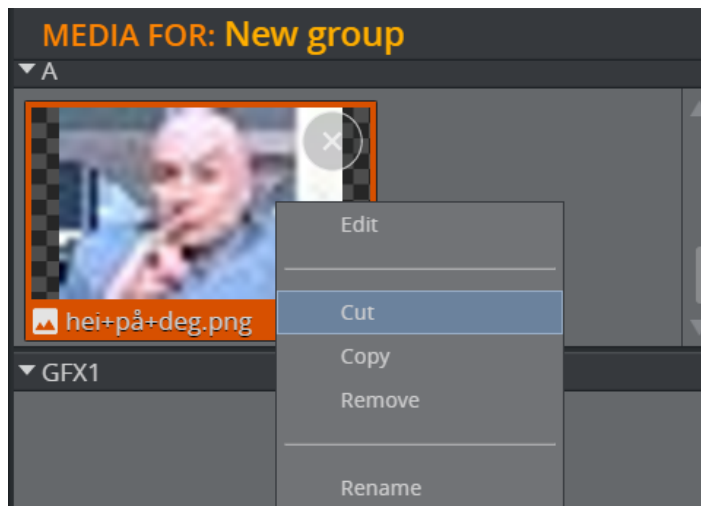

3. Right-click the channel you want to paste your element into.
4. Click **Paste**.

Select multiple elements

Select and move multiple elements.

Note:
These options are only available in off air mode.

Select multiple individual elements:

- Hold **CTRL** and click the desired elements.

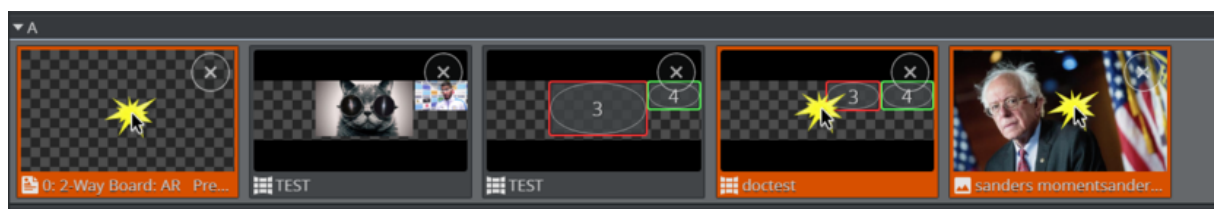

Select all elements between selections:

1. Click an element.

2. Hold **SHIFT** and click the last element in a row. All elements in between are selected.



4.5.2 Moving elements in on air mode

With 1-tap mode disabled

The following procedures apply when moving items between the Armed and Program columns. This presupposes a scenario where 1-tap mode is disabled. After all, the Armed column disappears with 1-tap mode enabled.

Move an element from the Media Column to the Armed column:

- Click the item in a channel in the Media Column.

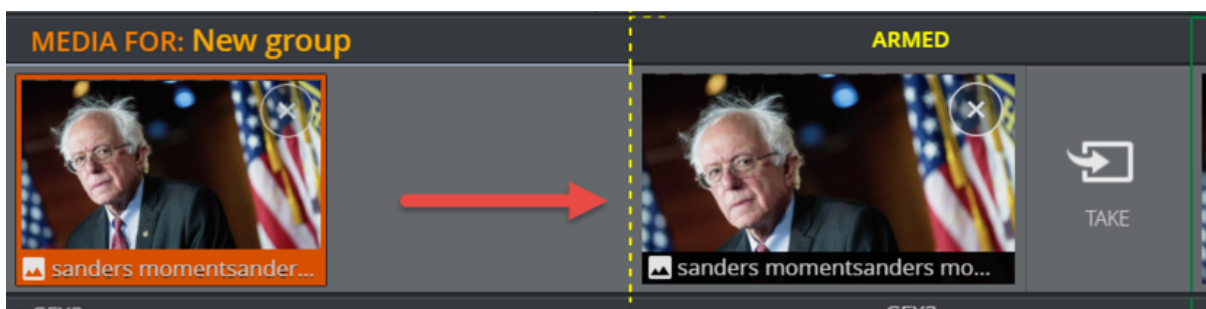

Note: This copies the element. The element now exists in the media column and armed columns.

Move an element from the Armed column to the Program (on air) column:

1. Click the element in the Armed column.

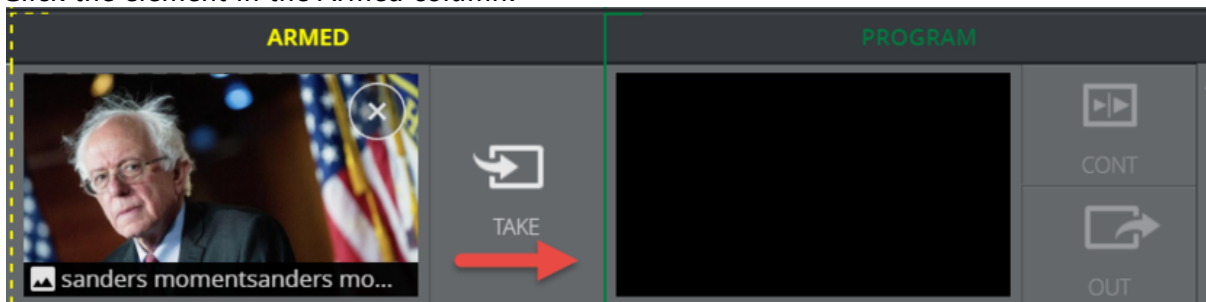

✓ **Tip:**
Clicking the **Take** button also moves the item from Armed to Program.

- The element now appears in the **Program** column.

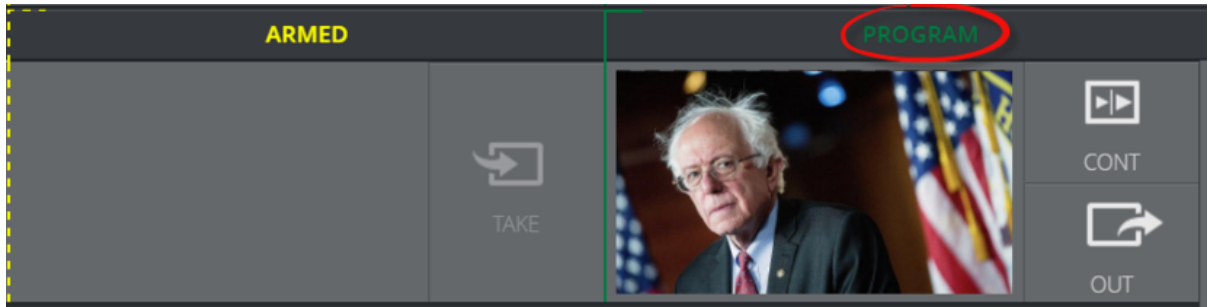

Move elements between channels in on air mode:

- Drag the element from one channel to another.



⚠ **Note:**
This creates a copy of the element, i.e. the element exists in both channels after dropping.

Move an element from one channel's armed column in a different channel's program column:

- Drag an element from an armed channel to another channel's program column.

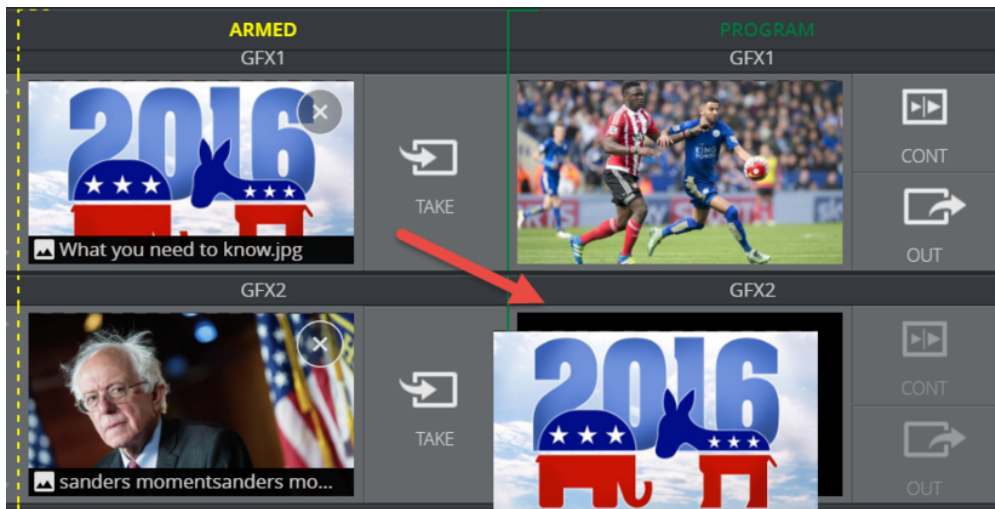

Note: This action will put the element you are dragging to air, replacing whatever element was already on air. You are also creating a copy, so the element now exists in both the armed column and program column, though in different channels.

With 1-tap mode enabled

The following procedures apply when moving items between the Media and Program columns in 1-Tap Mode.

Note: All of the following actions create a copy of the element, so they will exist in both places after dragging.

Move an element from one channel’s media column to the same channel’s program column:

- Drag an element from a channel in the **Media Column** to the same channel’s program column.

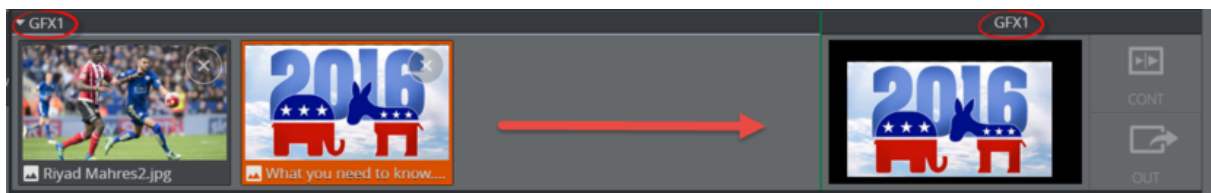

Move an element from one channel’s media column in a different channel’s program column:

- Drag an element from a channel in the media column to another channel's program column.



Move an element from one channel's program column in a different channel's program column:

- Drag an element from a channel in the program column to another channel's program column.

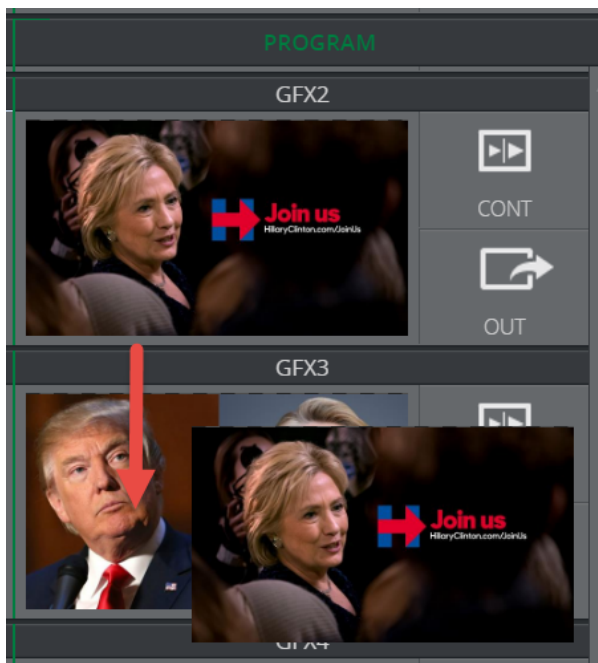

4.6 Sources Pane

Use the Sources Pane to find media for your show:

- [Media Tab](#) - search for assets in specified search providers
- [Inbox Tab](#) - content that is always available, across all shows
- [GFX Tab](#) - graphical elements to be used in your show

- [Videowall Tab](#) - presets (video wall layouts) and/or filled presets (video wall layouts including content)
- [Templates Tab](#) - Viz Pilot templates and elements

Note:
The Show/Hide button on the [Toolbar](#) allows you to [Hide Sources Pane and Show pane](#).

4.6.1 Media Tab

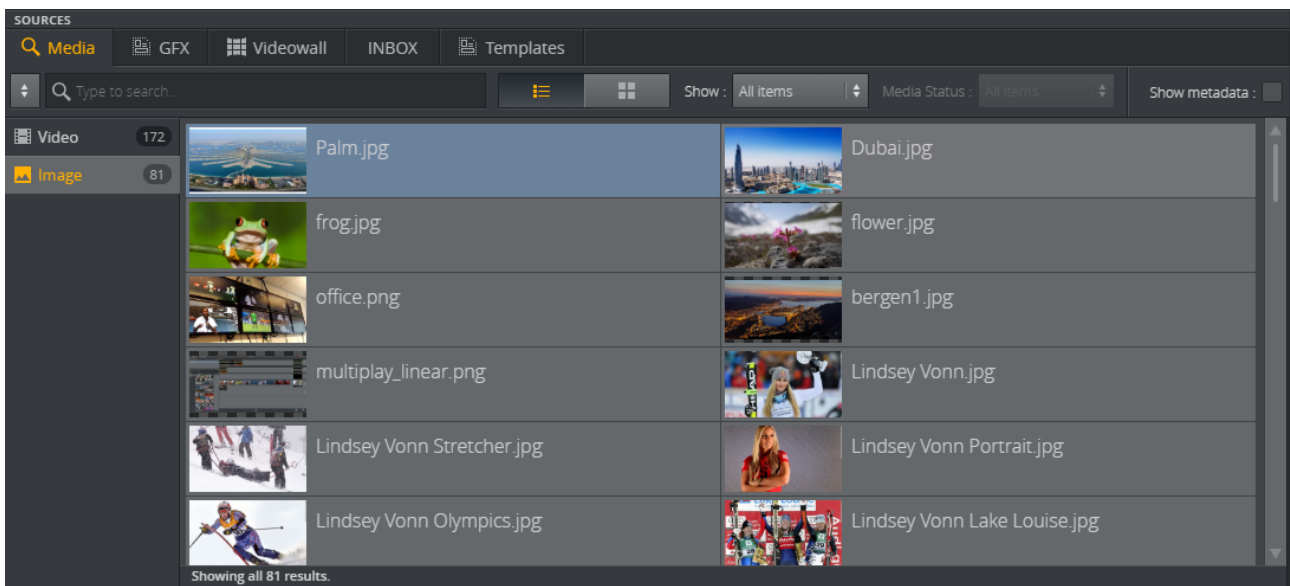

Note:
Before using the Media Tab, make sure your search providers have been configured in [Settings > Servers Tab](#).

In the Media tab, you can search for video and images in any of the search providers you have connected to, including Preview Server, Viz One, Pilot Data Server, Media Service and Graphic Hub. Once the element is found, drag it from the **Media Tab** to your channels.

Add items to channels from the Media tab

Drag individual items or groups of items into channels from the Media tab.

1. Click the Media tab.
2. Select a media type.

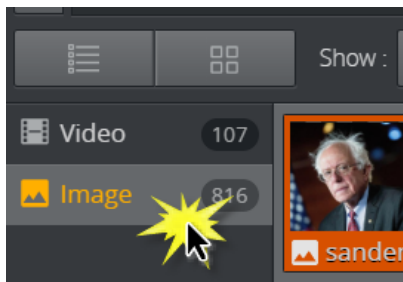

3. Drag an item into a channel.

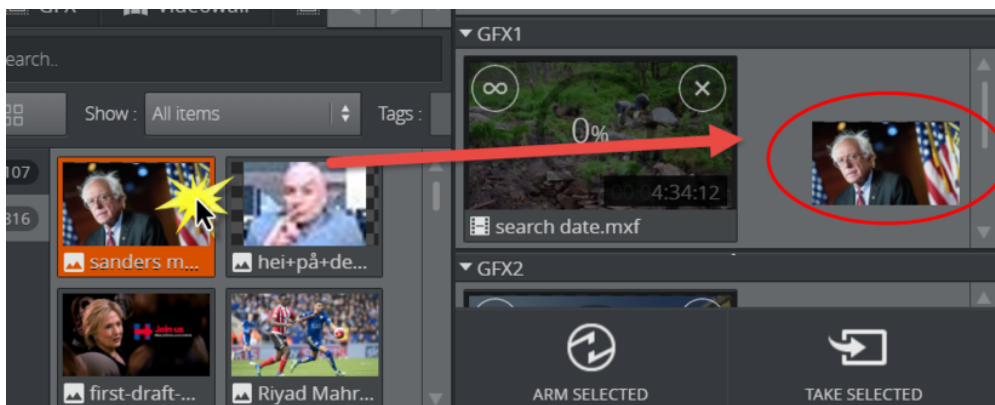

4. Hold CTRL and click multiple items to drag them as a group into a channel.

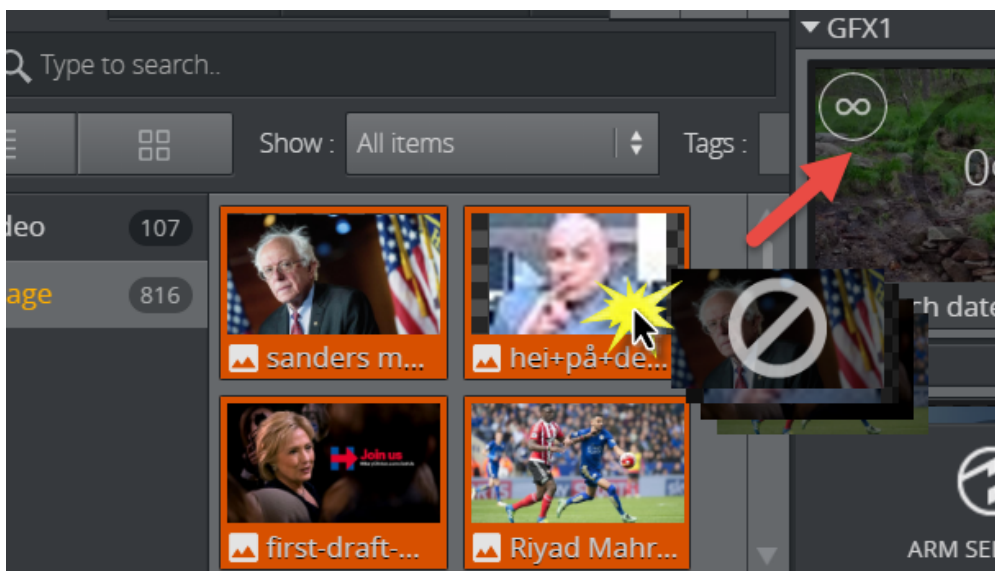

Media Search Filters

Note: Not all search criteria are supported for all search providers, so they will be hidden if not available.

- **Keyword search:** Searches descriptions

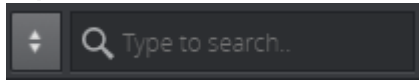

- **Media type:** Video or Image

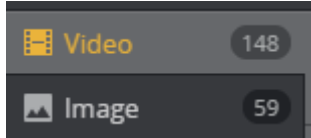

- **Date range:** Filter by date. All items, Last hour, Last day, Last week, Last month. Works with media from Viz One, Media Service, Pilot Data Server.

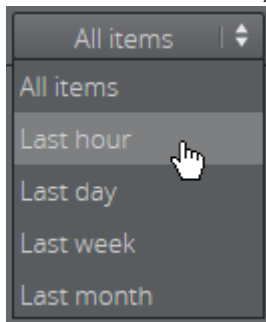

- **Tags:** Works with media from Pilot Data Server and Viz One. Only one tag can be selected at a time.

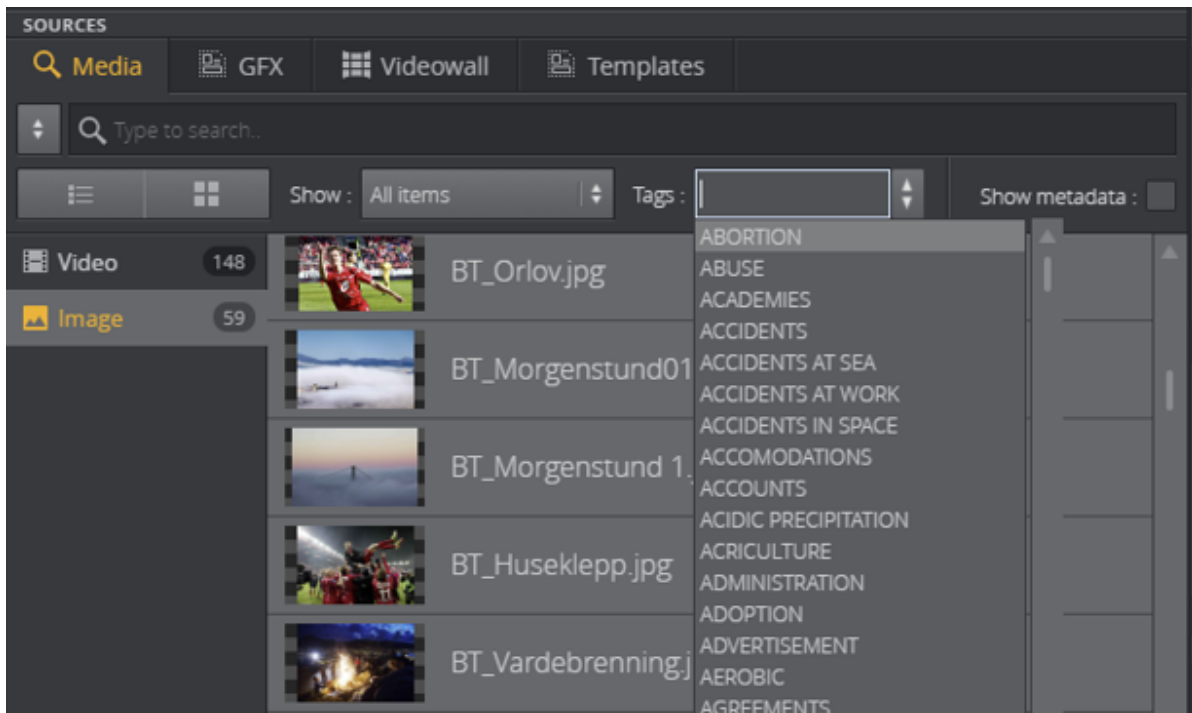

- **Search Provider:** Select the media sources you want to search in (Pilot Data Server, Media Service, Viz One, Graphic Hub and Graphic Hub: default folder).

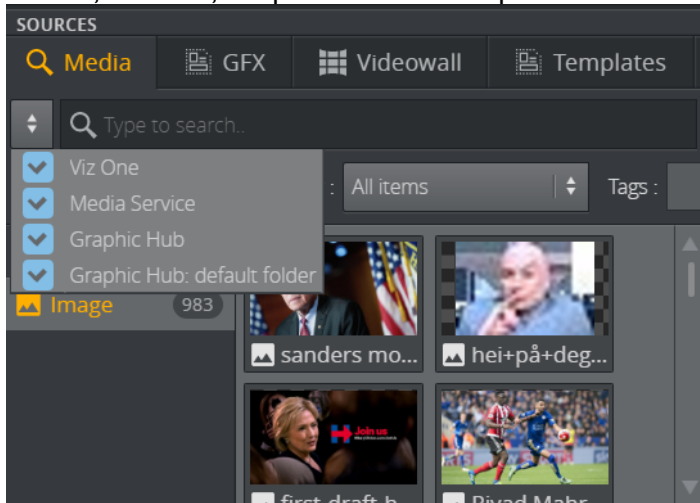

Note: GraphicHub REST service versions higher than 2.0.1 support **Graphic Hub: default folder** as a search provider, in addition to **Graphic Hub**. The default folder only contains images ingested through the Graphic Hub REST API, while the **Graphic Hub** search provider exposes the full content of the Graphic Hub.

Video Preview

To preview a video, right-click an item and select **Preview**.

Videos can be edited once they have been added to channels, see [Editing Videos](#).

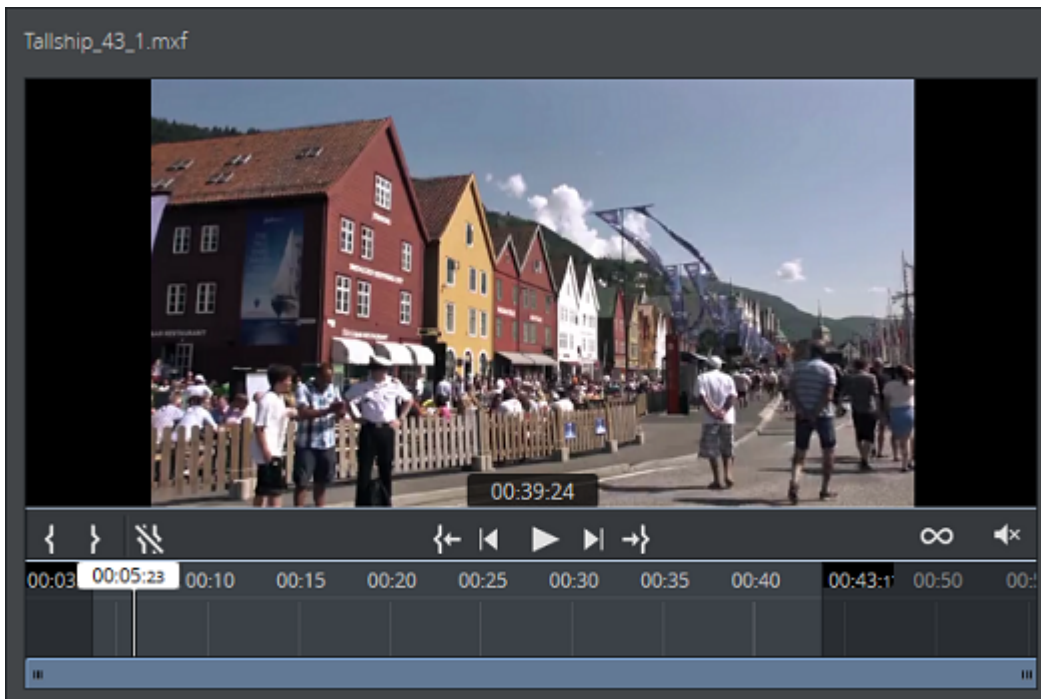

4.6.2 Inbox Tab

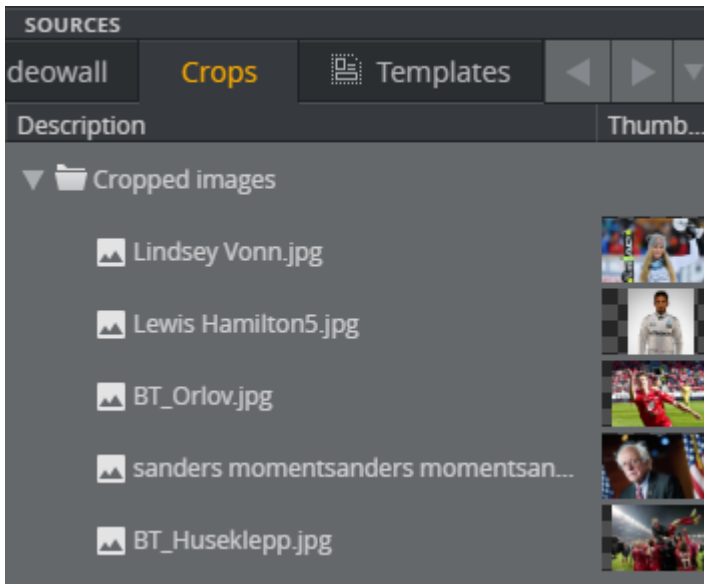

The Inbox feature allows users to work together to find and collect elements, that can be easily added to a story. An inbox is global, meaning that it is available regardless of the currently open show in Viz Multiplay.

An Inbox is a show that is marked as an inbox by selecting it in **Settings > Inboxes Tab**.

Any content added to this show (eg. *Crops*) is immediately available in the Inbox tab. The elements can be dragged from the Inbox tab to a channel.



Note:

When an element is dragged from the inbox to a channel in a show, the element is copied, not referenced. This means that after the drag operation, there will be two separate elements that can be modified independently of each other.

There are several ways to ingest elements into an inbox dynamically - for instance through the Media Sequencer REST API.

See Also

- [Inboxes](#)

4.6.3 GFX Tab

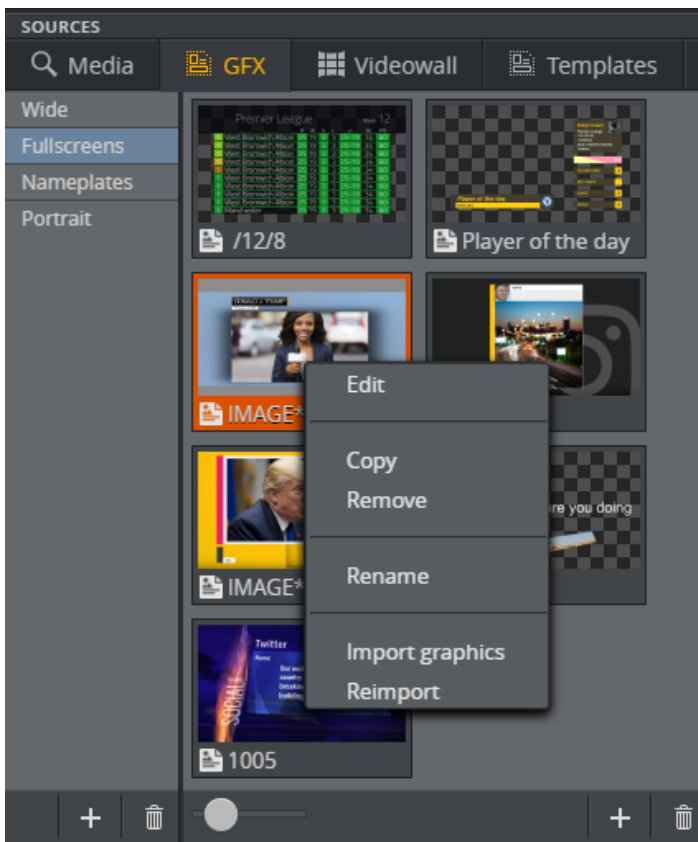

The GFX tab is a playlist within the show. It can be populated by importing Viz Artist scenes directly from the Graphic Hub or by using Viz Trio or the REST API of the Media Sequencer. It is also possible to drag or copy and paste elements from a channel into a group in the GFX tab.

The content from the GFX playlist is only available within the show in which the playlist is created. A playlist is set as the GFX tab by selecting it in **Settings > General Tab > Graphics**.

The graphical elements can be empty templates or filled with content and can be edited once they have been added to a channel, see [Editing Graphics](#). Any changes made inside an element are visible immediately.

The context menu

Right-clicking an element in the GFX tab brings up the following options:

- **Edit:** Open the default editor for this element. It can be useful to set default values or, for instance, write a better description of the graphics.
- **Copy:** Copies the element. It can be pasted anywhere in the channels.
- **Remove:** Deletes the element.
- **Rename:** Set a description for the element. Useful when the auto-generated description is not adequate.

- **Import Graphics:** Opens the Import graphics dialog box. This makes it possible to import graphics directly from the Graphic Hub.
- **Reimport:** Re-imports the graphics from the Graphic Hub. This is useful if the graphics designer has added or removed control fields.

Changing thumbnail size and aspect ratio

Use the slider to increase the size of the thumbnails in the GFX tab.

- Drag right to view bigger thumbnails and left to view smaller thumbnails.



The thumbnails for each group in the GFX tab can have different aspect ratios. This is handy if you have wide scenes or portrait scenes meant for playout in GFX channels with the same aspect ratio.

- Right-click a group in the GFX tab.
- Select **Set Aspect Ratio**.
- Choose an aspect ratio or select **Custom**.
- In the custom box - enter a numeric value (width divided by height).

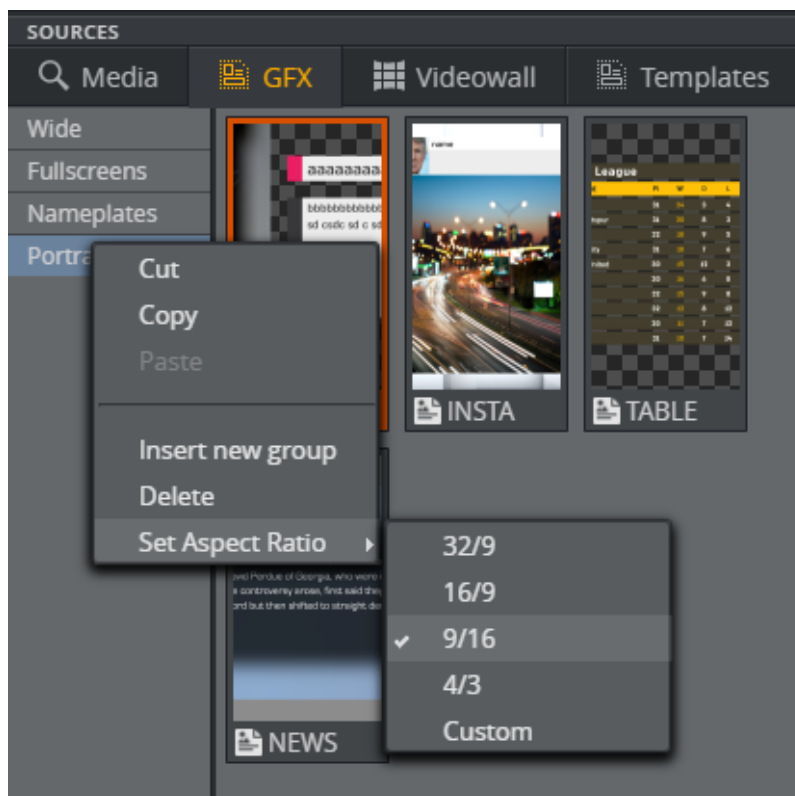

See Also

- [Edit graphics, videos and images](#)
- [General Tab](#)

4.6.4 Videowall Tab

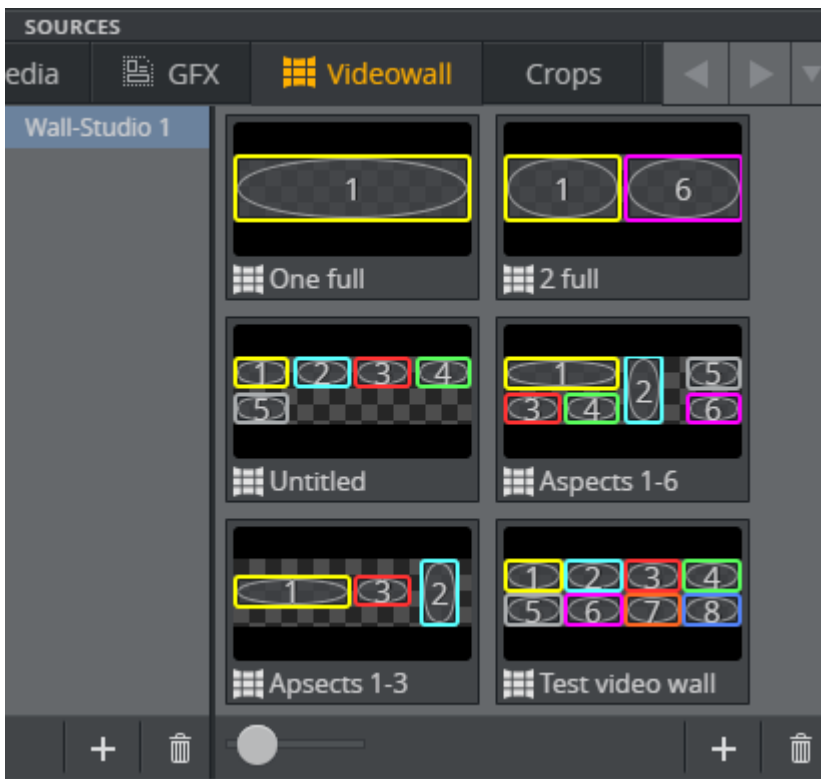

The Videowall tab is a playlist within the show. It contains a set of [Presets](#) (video wall layouts). The content from this playlist is only available within the show in which the playlist is created.

A playlist is set as the Videowall tab by selecting it in **Settings > General Tab > Videowall**.

The presets can be empty video wall layouts, or can be filled with content (media and scenes). The elements can be edited once they have been added to a channel (see [Editing Presets](#)). Any changes made inside an element are visible immediately.

Viewing elements in the Videowall tab

- Drag the slider to the right to view bigger presets and left to view smaller presets:



Connect a videowall group to a videowall

Playback all the presets in a group on a specific videowall.

✓ **Tip:**
Create one group for each videowall in a profile.

1. Right-click a group in the Videowalls tab.
2. Select the desired videowall together with its main channel (the Viz output on which the videowall presets are run).

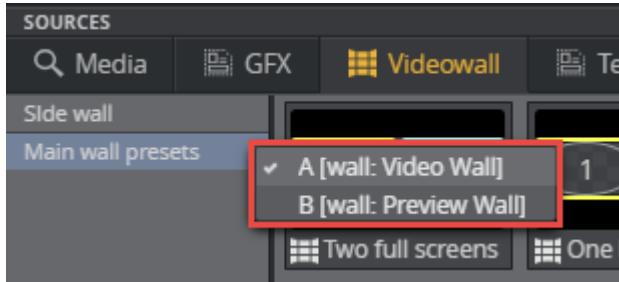

3. Now, this group only contains presets assigned to the selected videowall.

See Also

- [Presets](#)

4.6.5 Templates Tab

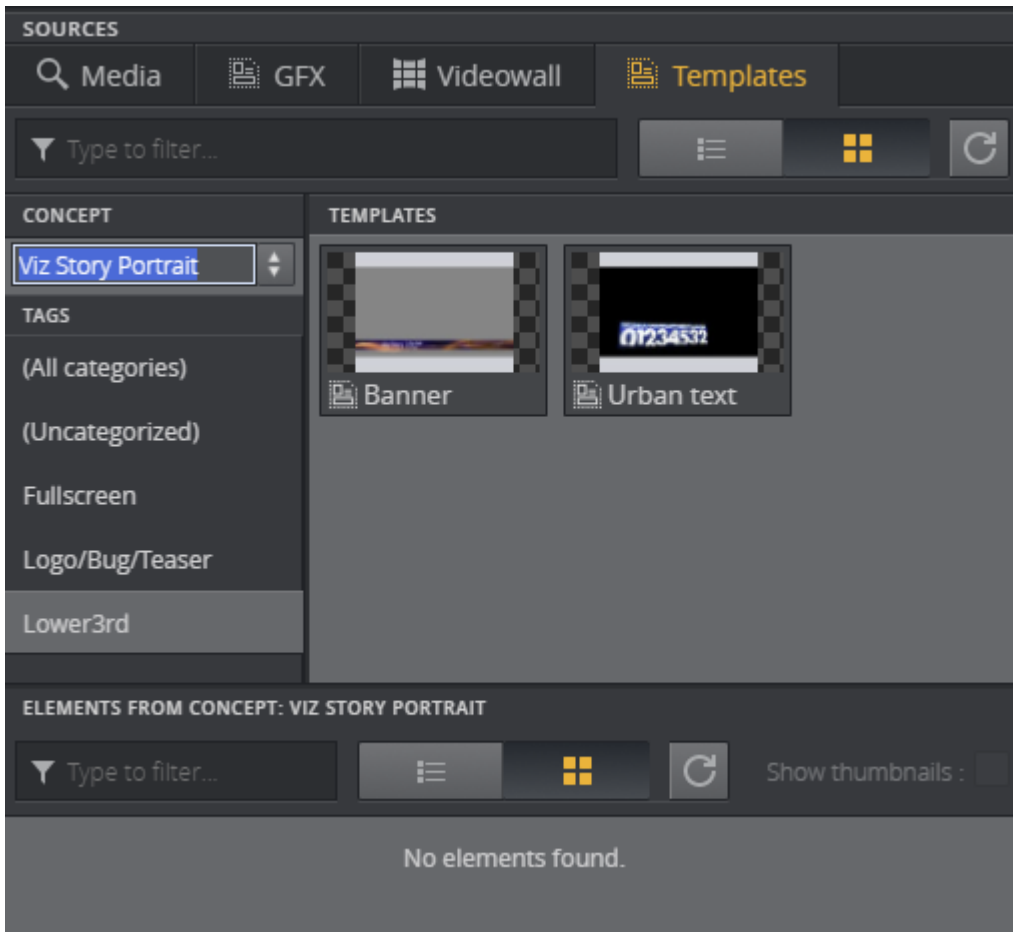

The Templates tab gives you access to **Viz Pilot templates** and elements. It is available if you have Viz Pilot configured as a search provider in **Settings > Servers Tab**.

Browse for a Viz Pilot template or an element. Right-click and select Preview to preview the graphics in a higher resolution.

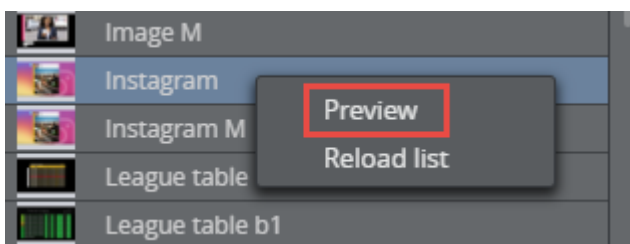

Drag templates directly into your channels. This will automatically create a new Viz Pilot element.

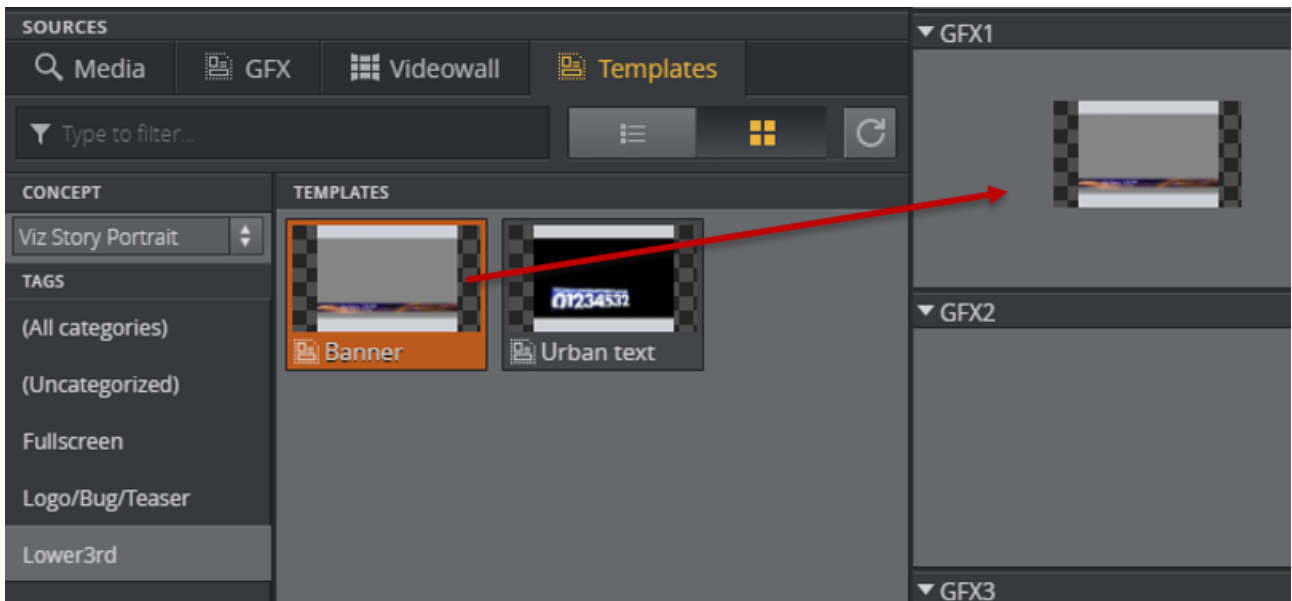

The templates can be edited once they have been added to a channel (see [Editing Graphics](#)). Any changes made inside an element are visible immediately.

See Also

- The templates tab also appears in the [Preset Content Editor](#).

Working with data elements

Drag data elements from the Templates Tab into channels in the [Media Column](#).

Learn more:

- [What are data elements?](#)
- [Where do I find data elements?](#)
- [Refreshing the data elements list](#)
- [Filtering data elements](#)

⚠ IMPORTANT!
This feature requires Pilot Data Server 7.2 or higher.

What are data elements?

Data elements are variations of a template.

For example, the same lower third may be used in both the morning and evening shows. Two different elements are created from a single template, each containing styling specific to the show it is created for. The morning show element has a green lower third while the evening show element has a red lower third.

Where do I find data elements?

Elements are accessible at the bottom of the templates tab. Drag them into channels in the same way as templates.

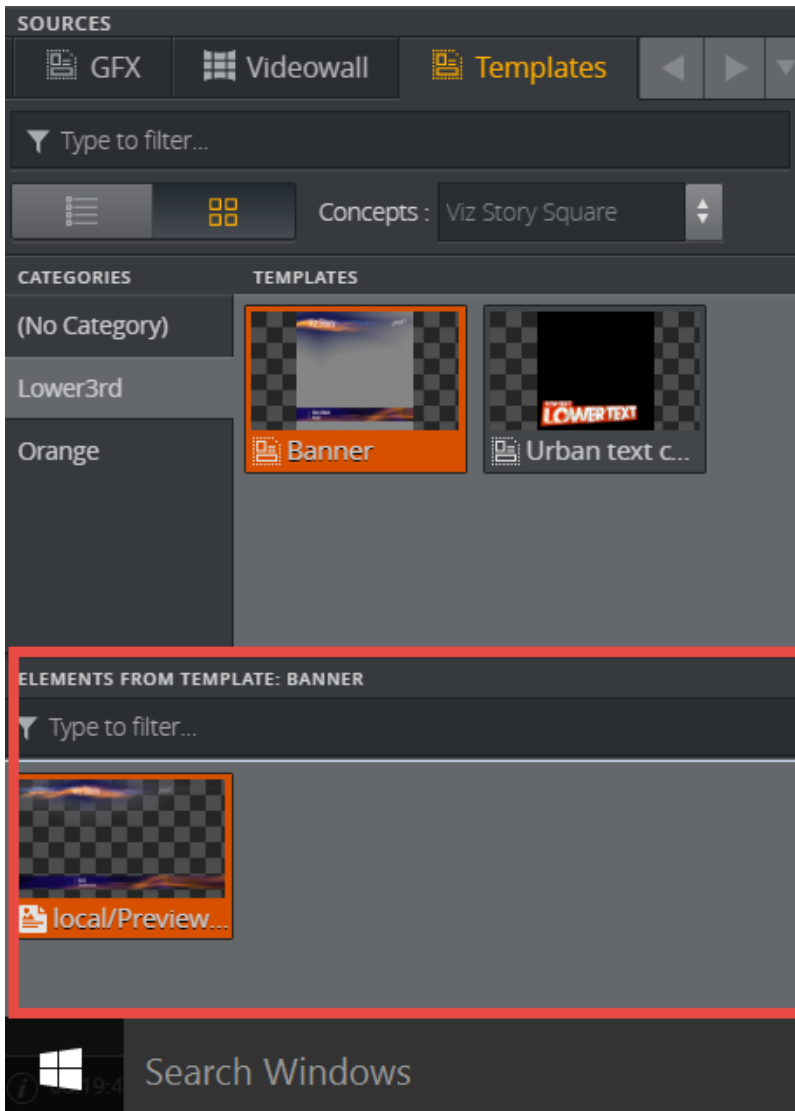

Refreshing the data elements list

The data elements list is read out from the Pilot Data Server when a concept or a template is selected. This list does not change, even if someone is changing the list on the server. The list must therefore be refreshed manually.

To refresh the list:

1. Right-click an element in the data elements list.

2. Click **Reload list**.

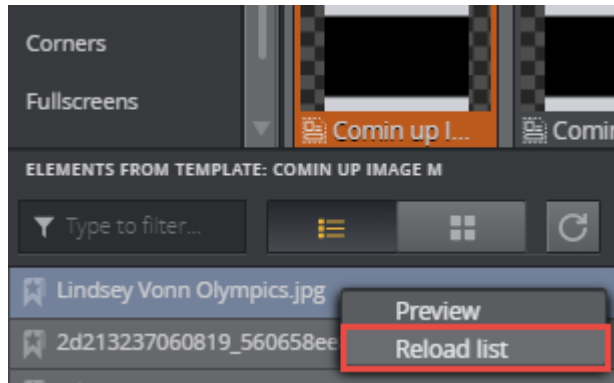

The current subset of data elements will now be reloaded from the server.

Filtering data elements

Multiplay groups elements by concept and by template.

Note:
Filtering data elements by category is not possible.

View elements by concept

Show all data elements belonging to all templates in a concept.

1. In the Templates Tab, click the Concepts menu and select a concept.

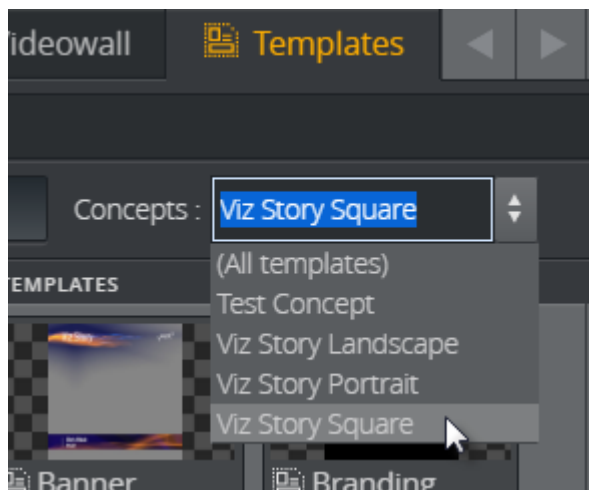

2. Both templates (1) and elements (2) for the selected concept are listed. Here, the **Viz Story Square** concept has a number of templates and two elements, that is versions of those templates.

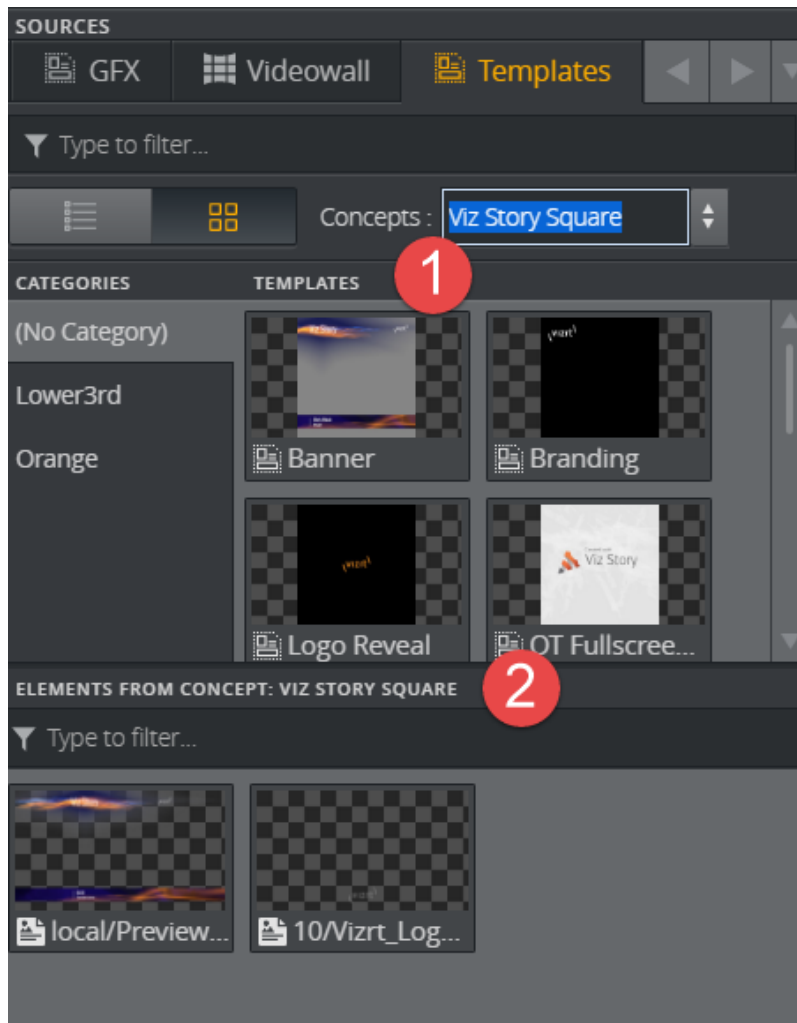

✓ **Tip:**
 The elements window title shows **Elements from concept** to remind you that you are viewing elements associated with a concept.

View elements by template

Show all data elements belonging to a specific template.

1. In the Templates Tab, click a particular template to view its elements.

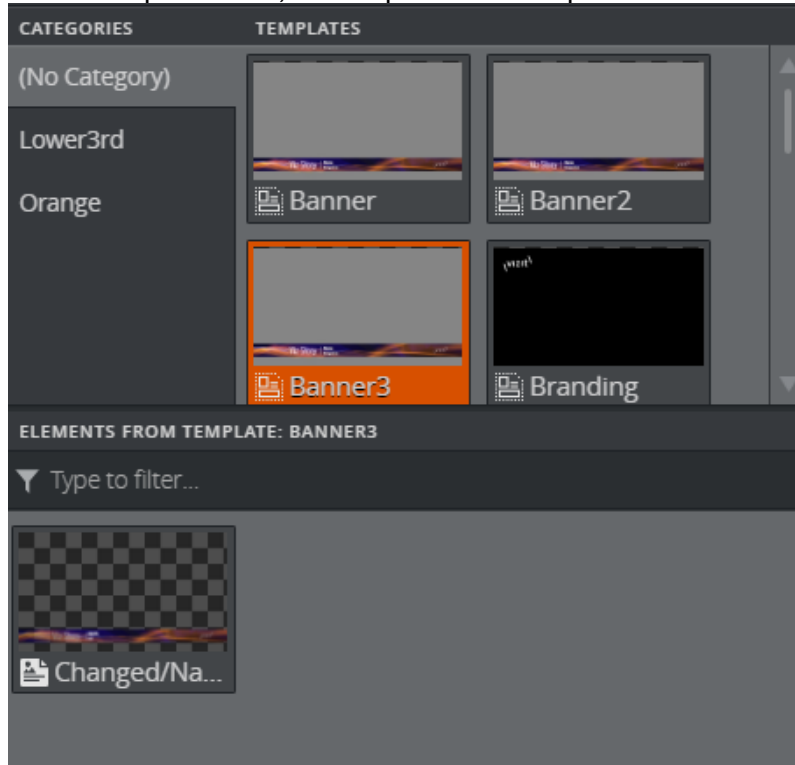

2. Here, the **Banner3** template has a single element titled **Changed/Na...**

✓ **Tip:** The elements window title shows **Elements from template** to remind you that you are viewing elements associated with a single template.

List and Grid View

In the Templates Tab, click



to view elements and templates in list or grid view.

See Also

- [Pilot Data Server Administrator Guide](#)

4.7 Workspaces

The workspaces can be used to adapt the GUI to one specific role, such as the anchor in the studio or the person responsible for playing out a part of the video wall or control one of several different video walls. In each workspace, it is possible to:

- **Hide channels** that should not be visible for the Viz Multiplay operator.
- Specify a **custom set of shortcut tabs** - shared or private to the workspace.

- Specify a **keyboard shortcut** to activate this workspace.
- **Privately Arm elements** without affecting armed elements in other workspaces.

This section will explain more about:

- [Hiding channels](#)
- [Shortcuts per workspace](#)

4.7.1 Hiding channels

A workspace can specify channels that should not be visible. For instance, the main channel should often be hidden from the user in a video wall setup. The main channel of a video wall is used to play out the presets, which are usually located in the Shortcuts bar. It is therefore not necessary to populate or show the main channel (normally called **A**) in the GUI.

To hide the **A** channel:

1. Go to **Settings > Workspaces**
2. Create a new workspace by clicking the **Add (+)** button in the Workspaces list
3. Add the names of the channels you wish to hide by clicking the **Add (+)** button in the Hidden Channels list

 **Tip:** Hide multiple channels by right-clicking the Hidden Channels panel and selecting the relevant channels from the context menu. See [Hide channel context menu](#).

4. Enter the name of the channel to hide

 **Note:** This will hide the channel regardless of which profile is active. If you hide channel **A** in the workspace, the channel called **A** will be hidden for all profiles you activate.

5. Activate the workspace by clicking the **Activate** button

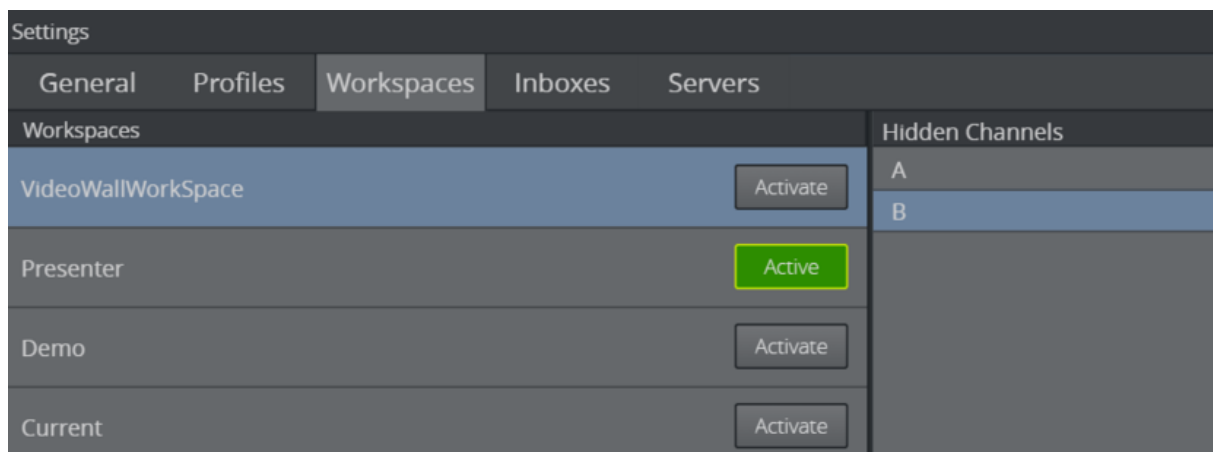

4.7.2 Shortcuts per workspace

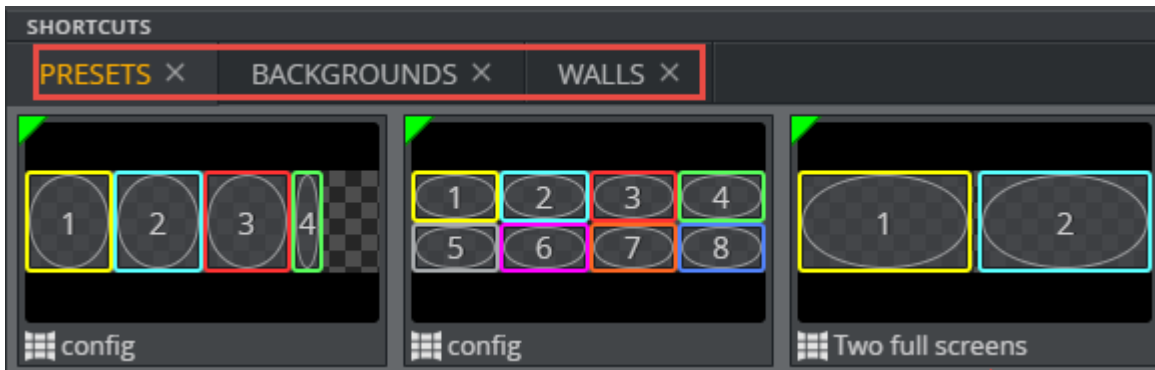

Shortcut tabs in a show can be shared between all workspaces or they can be assigned to specific workspaces.

- Go to **Settings > Workspaces**
- Click a workspace.
- Check **Only show selected shortcuts**
- Check one or more shortcuts group listed

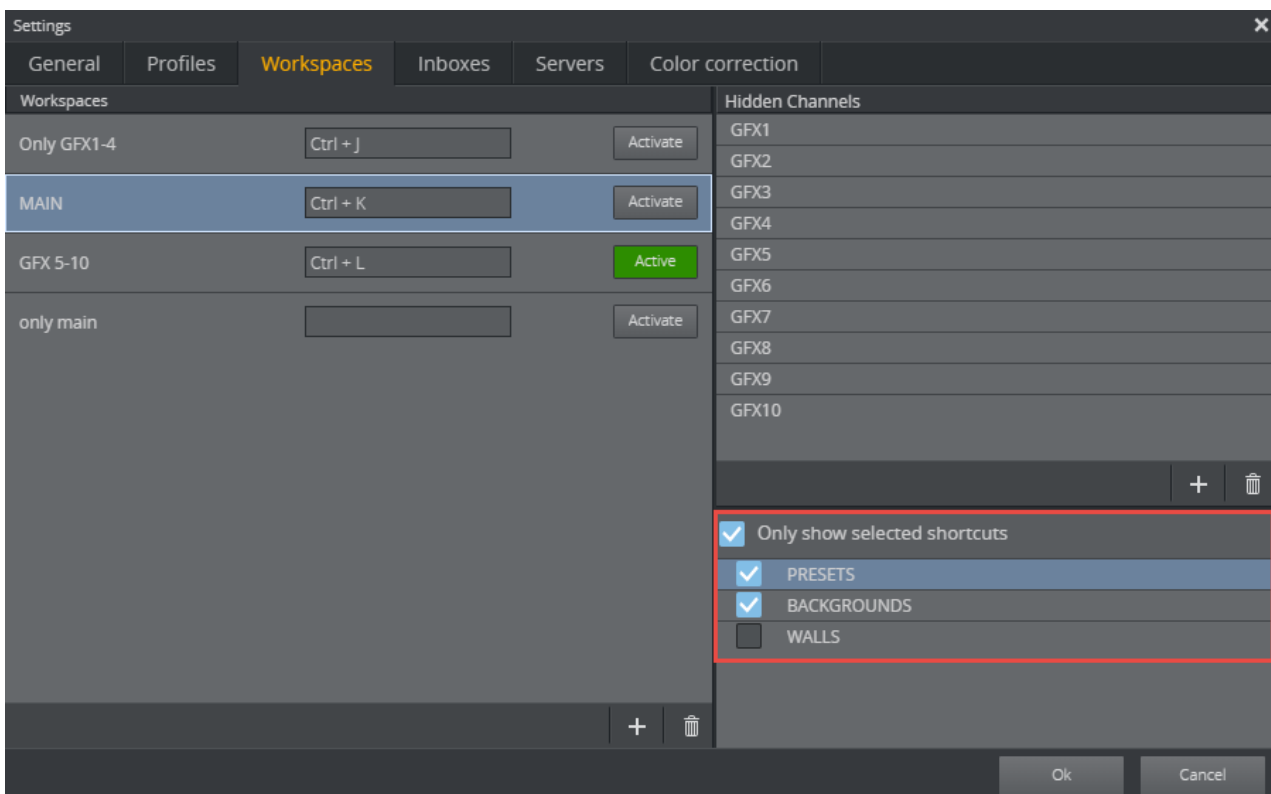

If **Only show selected shortcuts** is checked, and no workspace is active - all shortcut tabs are visible.

If **Only show selected shortcuts** is checked, and a workspace is active - only the checked shortcut tabs in the list will be active. One shortcut tab can be visible in multiple workspaces. When

creating new shortcut tabs when **Only show selected shortcuts** is checked, the new tab will automatically belong to the active workspace.

4.8 Arming And Taking Elements

This section explains the functionality in the Media pane, including:

- [Media Pane](#)
- [Armed](#)
- [Program](#)
- [Arm and Take Multiple Elements](#)
- [Reload Scene](#)

4.8.1 Media Pane

The Media pane is used to manage elements that have been prepared for the story.

Each channel is displayed on a separate row and can be managed individually or together with other channels.

Elements that are ready for use listed in the [Media Column](#), while the [Armed](#) and [Program](#) columns display the elements that are currently armed or on air.

To manage multiple channels simultaneously, you can [Arm and Take Multiple Elements](#).

The [Shortcuts Bar](#) is used to arm and take presets and other shortcuts.



Note:

Adding videos to a graphics-only channel or graphics to a video-only channel will result in the element not being played out correctly. Composite elements will only work on channels that support both graphics and video.

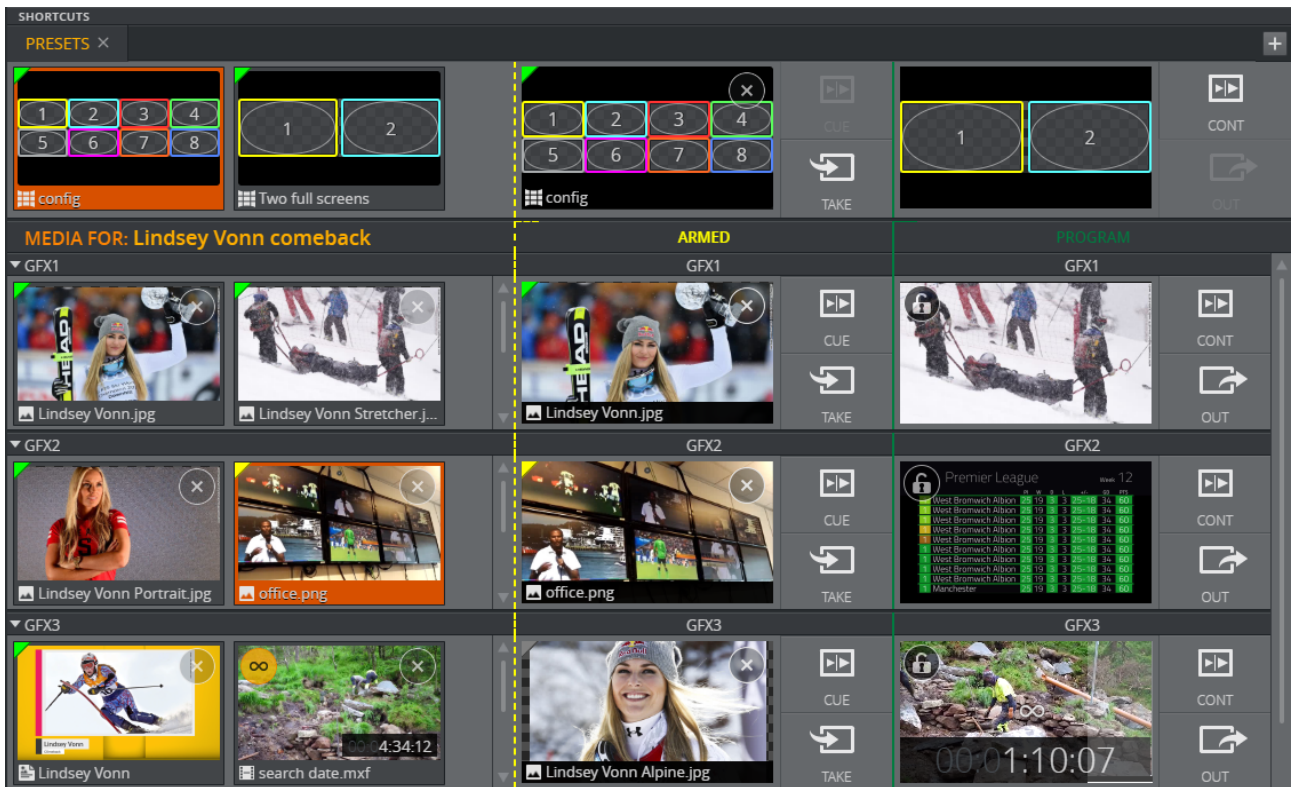

Media Column

The leftmost part of the Media Pane contains the elements that are ready to be played out. They belong to a page list or a playlist, and they are assigned to one channel in the active profile.



Note:

All changes made to elements in this column will be reflected in Viz Trio.



This section covers the following topics:

- Options in On Air mode.
- Shortcut menu for elements in the Media Column.

Options in On Air mode

With **On Air Mode** enabled it is possible to prepare (arm) and play out elements. This can be done in different ways:

- Right click on an element to open context menu that contains supported actions for that element.
- **Click** an element to move it to **Armed**.
- **Drag** an element to Armed or Program in another channel to make a copy there (original remains in source channel).
- **Drag** an element to the Media Column in another channel (removes it from source channel).

- Turn **Looping** of the video ON  or OFF .

Note:
You cannot change the looping setting once the clip is playing. To stop the looping you need to take out the clip.

- **Delete** an element (X Button) or Remove from the context menu.

Note:
To show or hide the X button can be set in the General tab in [Settings](#).

- The thumbnail indicates when the element is still **loading**, as shown below. The loading status indicates whether the clip is transferred from the MAM system, like Viz One.

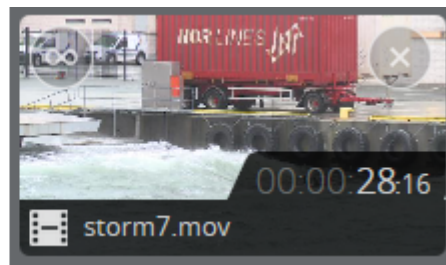
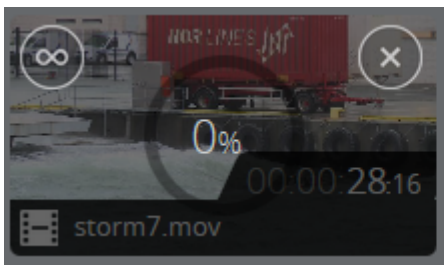

In **1-Tap Mode**, you can:

- Click an element to move it directly to **Program**.
When elements have been selected in several channels (1 element per channel):
- **Arm Selected:** Send all selected elements to **Armed**.
- **Take Selected:** Send all selected elements to **Program**.

Shortcut menu in the Media Column

Right-click elements (videos, images and graphics) in channels in the Media Column to expose a context menu.

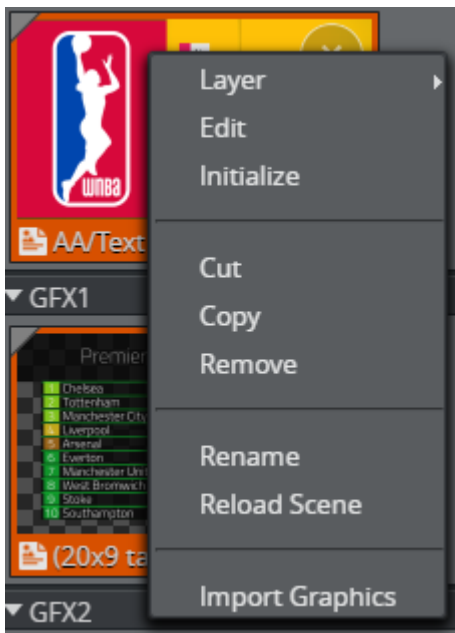

- **Layer:** (only in non GFX channels): Set the Viz layer (FRONT, MAIN or BACK).
- **Edit:** Opens the corresponding editor. (Image Effect Editor, Clip Editor or the Fill-in Form for graphics).
- **Initialize.** Loads the resources of this element into the memory of the renderer. This function is available for images and graphics. This operation makes sure that the element is played out instantly in a Take. It can possibly be disruptive for the animations or clips playing on the renderer, so it is advised to initialize before the broadcast starts, or when there is low activity on the renderer. The colored triangle in the top left corner of the elements in the Media pane indicates whether the resources are loaded on the renderer. Green is loaded, yellow is loading, and gray means unloaded. If the graphics is not loaded, it may take some time before the renderer plays the graphics when a Take operation is executed.
- **Cut:** Cut an element.
- **Copy:** Copy an element.
- **Remove:** Remove element from the channel.
- **Rename:** Rename an element.
- **Reload Scene:** Reload the scene from the Graphic Hub.

Note: This option is only visible when right-clicking graphics in the media, armed and program columns. See [Reload Scene](#) for more information about this feature.

- **Import Graphics:** Import graphics directly from Viz Graphics Hub into this channel.

4.8.2 Armed

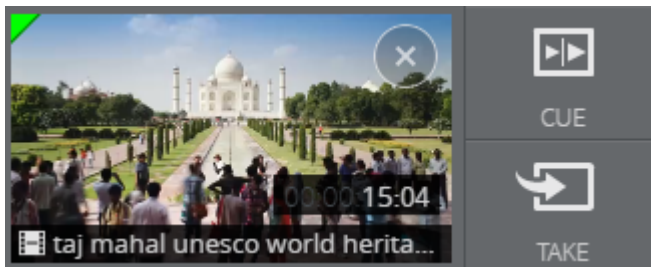

When graphics or images are armed, the content is ready for playout on the channel it belongs. This operation is not going to prepare anything for playout on the renderer - it is purely an operation for the operator to visualize what is going to be played out next.

Arming clips. When clips are moved to Armed, they are *prepared* on the Viz Engine. This means that the clip is set in its first frame in the background of the player, so they are ready to be taken with less latency than if they were not armed. The preparing is done in the background, without disturbing the running clips. The colored triangle in the top left corner of the armed clip indicates whether the clip is prepared in the renderer. Green is good to go. The clip will play out instantly.

Users with the same *active workspace*, share the armed column. For more information see [Sharing Armed and Program Status with Workspaces](#).

It is possible to:

- Click an element to take it to [Program](#).
- Click the Take button to take the element to [Program](#).
- Click the CUE button (enable this in Settings) to send the element to [Program](#) in the first frame in the renderer ready to be played out.
- Click the CONTINUE button (enable this in Settings) to continue the graphics or video on the external preview engine. Only available if external preview is used.
- Drag an element to [Armed](#) or [Program](#) in another channel to make a copy there (this does not affect or take the original armed element).
- **Take All:** Send all armed elements, for all channels, to [Program](#).
- **Cue All:** Send all armed elements, for all channels, to [Program](#) in the first frame in the renderer ready to be played out.
- See the **Looping** status of the video.

⚠ Note:

It is not possible to change the looping setting in the Armed column. Use the looping button in the Media column.

- **Remove** an element from the Armed column by clicking **X**.

Armed Shortcut Menu

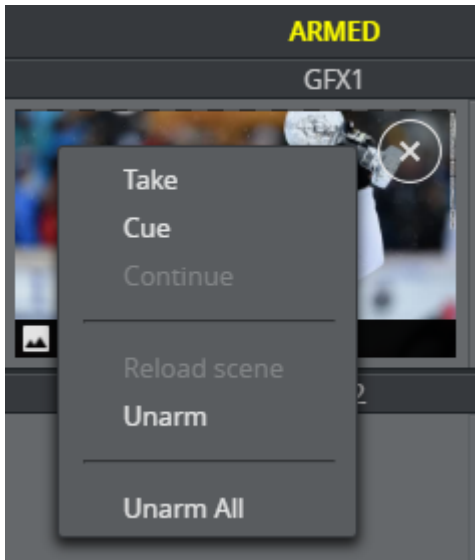

- **Take:** Take the armed element on the Program renderer.
- **Cue:** Set the armed element ready in its first frame on the Program renderer.
- **Continue:** Continue the animation or clip on the external Preview renderer. Only enabled if an external preview is configured for a video wall.
- **Reload scene:** See [Reload Scene](#).
- **Unarm:** Unarm the armed element.
- **Unarm All:** Unarm all armed elements.

4.8.3 Program

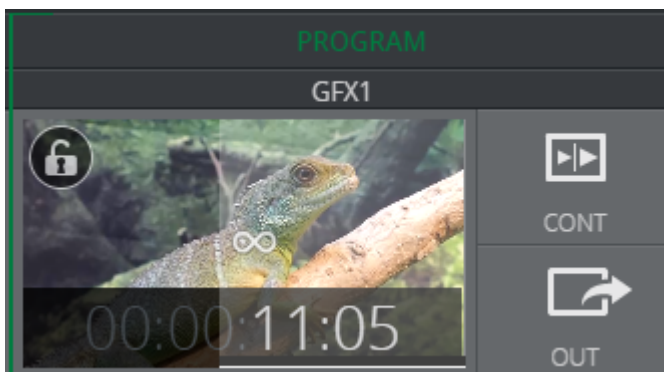

The elements in the Program column are playing on air in the given channel.

**Note:**

Using a Media Sequencer version 5.0 or higher, the Program column will not only show the last taken element, but snapshots of all the layers that are in the renderer at a given moment. This means that when a Transition Logic layer is taken in (for instance a banner), and another layer is taken in (for instance a clock or a side panel) - the Program column will actually show both of these layers, and not only the last taken element.

User can:

- Click the **CONT** button to continue a graphic element or Cued elements.
- Click the **OUT** button to take out the element.

**Note:**

Using a Media Sequencer version 5.0 or higher, the **OUT** button takes out content on all layers in the renderer, also Transition Logic layers - and not only the last taken element.

**IMPORTANT!**

OUT will not be enabled for a main- or shortcut channel having a **video wall preset** on air. When operating a video wall, a preset should always be on air - even if the channels are empty. The preset will ensure that content always can be played out directly in the GFX channels on the wall.

- **Drag** an element to [Armed](#) or [Program](#) in another channel to make a copy there (this does not affect the original program element).
- **Continue All:** Continue all program elements in all channels, including cued elements.

**IMPORTANT!**

Continue All will not continue elements in the Shortcuts Bar. Only elements in regular channels that are visible in the GUI (also collapsed channels) are affected. Channels hidden by the active Workspace are not affected.

- **Out All:** Take Out all program elements in all channels.

**IMPORTANT!**

Out All will not take out elements in the Shortcuts Bar. Only elements in regular channels that are visible in the GUI (also collapsed channels) are affected. Channels hidden by the active Workspace are not affected. Out All has a fail-safe that provides an extra confirmation step when clicked. See [General Tab](#) for more information.

- See the **Looping** status of the video.

**Note:**

It is not possible to change the looping setting once the clip is playing. To stop the looping, take out the clip and toggle the looping OFF in the Media column.

- **Display a snapshot** of the clip/graphic (clips can either play or be represented as a static snapshot depending on the setting *Play videos locally in Program* in [Settings](#)).

Note:
The preview shown in the Program column may not be precisely in sync with the actual output. It is only an indication.

Locking a channel

Each Program channel has a lock symbol. When clicked, no changes to this channel can be done from the Viz Multiplay client:

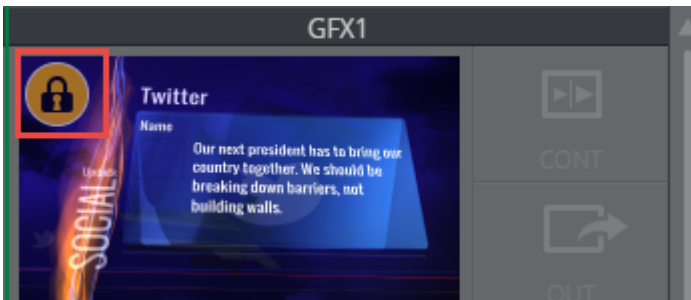

The Continue button and the Out button are disabled. This can be handy if a channel should stay on air (like a background or a part of a video wall), preventing accidental changes to the content. Also, the Out All and Continue All buttons will not affect locked channels. A common use case can be to lock some channels, and click Continue All - then only the unlocked channels will get the Continue command. Note that other Viz Multiplay clients can change the content of this channel. The lock is private for the current client.

Program Shortcut Menu

- **Play:** Play the video from the current frame, if the video is paused or cued (the same as clicking Continue).
- **Pause:** Pause the playing video.
- **Re-Cue:** Rewind the video to the first frame and freeze it (the same as Cue).



Time Remaining

The time code is displayed for all videos and graphics. The time remaining for a clip is indicated with a gray progress bar. Orange shading indicates <20 seconds remaining, and red indicates <10 seconds remaining. Only the gray progress bar is shown on looping clips.

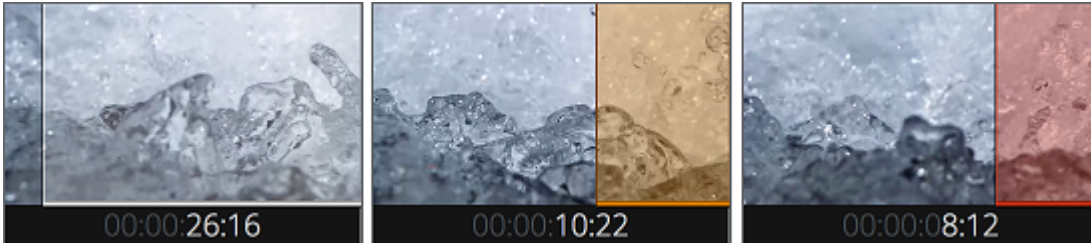

4.8.4 Arm and Take Multiple Elements

Action Bar

Note:
The Action Bar hides from the interface when in Off Air Mode, see //onairmode

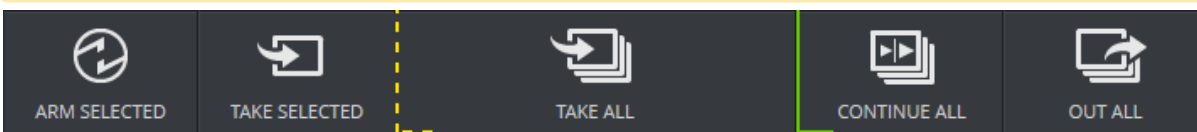

- **Arm Selected:** Send all selected elements in the [Media Column](#) to [Armed](#).

Note:
Arming clips cues them on the Viz Engine clip players, so that they are ready to be taken with less latency than if they are not armed first.

- **Take Selected:** Send all selected elements in the [Media Column](#) to [Program](#).
- **Take All:** Send all [Armed](#) elements, for all channels *and shortcuts*, to [Program](#).
- **Continue All:** Continue all [Program](#) elements, in all channels.
- **Out All:** Take Out all [Program](#) elements, in all channels.

Note:
The [Shortcuts Bar](#) is unaffected by the Continue All and Out All buttons.

4.8.5 Reload Scene

Update on-air graphics with the reload scene option. This feature is useful when changing scenes on the fly in Viz Artist and quickly taking them to air.

To activate Reload Scene:

- Right-click a graphic in the media pane (shown below) or in the armed or program columns.

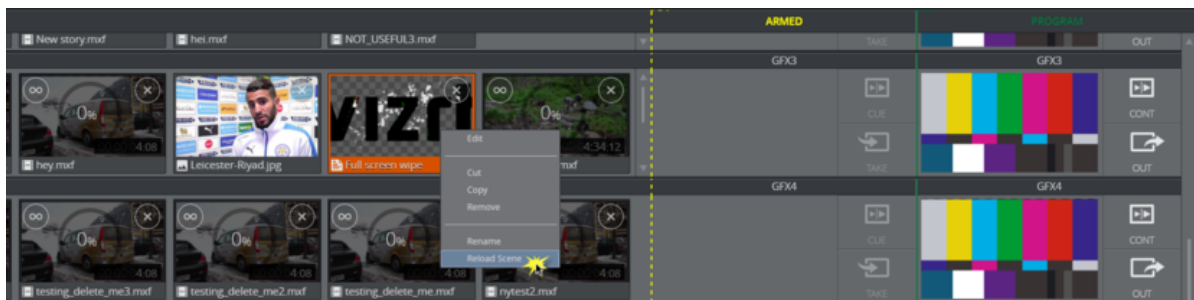

Workflow

A graphic is showing live on a video wall. As the graphic is in use, a scene designer changes it in Viz Artist. Bring those changes to air by following these steps:

1. Send a graphic to air in the program column.
2. The scene, which is now in use on a video wall, is opened in Viz Artist and changed by a scene designer. The new scene with changes is saved in the Graphic Hub.
3. You now want to update the on-air graphic to reflect the changes.
4. Right-click the graphic in the program column of the channel where the graphic is playing out and click **Reload Scene**.

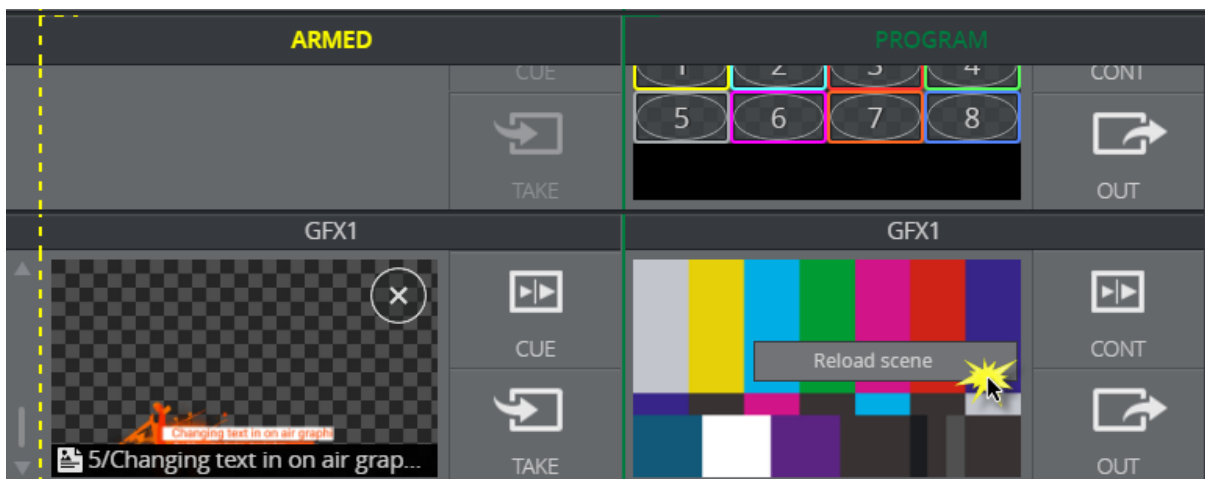

Tips for using Reload Scene

Consideration	Solution
<p>Default data is inserted into an on-air graphic's editable field after clicking Reload Scene. This only applies for graphics with a payload editor, not for, for example, graphics such as a bug.</p>	<p>Once a graphic is ready to be reloaded, take it out from the program column. Locate it again in the relevant channel in the media pane and click Reload Scene. You can now send it to air with the new changes.</p>

4.9 Shortcuts Bar

The Shortcuts Bar gives fast access to frequently used elements, such as scenes, backgrounds or videos. In addition, video wall [Presets](#) can be selected and modified from the Shortcuts Bar.

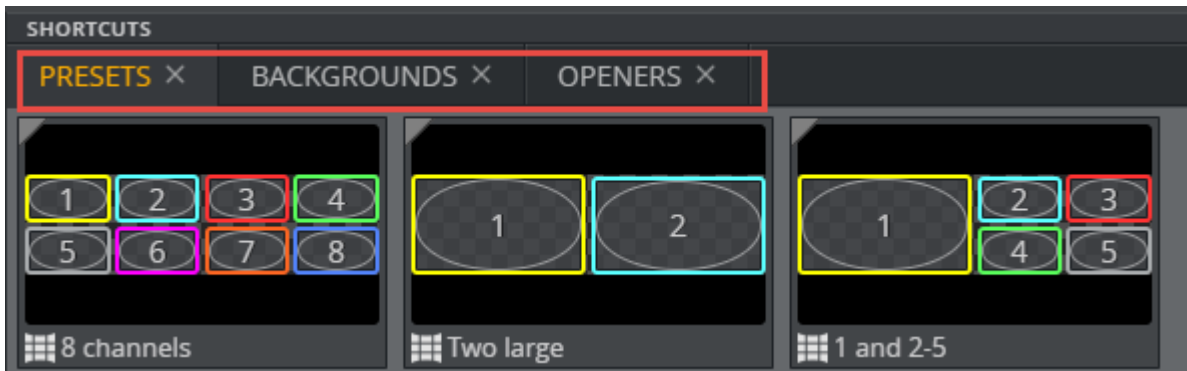

The Shortcuts bar is actually a playlist within the show, so the content from this playlist is only available within the show in which the playlist is created.

A playlist is set as the Shortcuts bar by selecting it in **Settings** > [General Tab](#) > **Shortcuts**.

Users can have **multiple tabs** of shortcuts to make it easy to access items that are used frequently, independent of which story you are working on. Each group in the Shortcuts bar playlist appears as a tab in the Shortcuts bar. The shortcuts are specific to a show so that when you change your show you can have different shortcuts for different productions.

It is also possible to have shortcuts tab per workspace. This means that two workspaces can have different shortcuts. See [Workspaces](#).

This section will explain more about:

- [Elements in the Shortcuts bar](#)
- [Layers](#)
- [Working with the Shortcuts Bar](#)
- [GFX preset mode](#)

4.9.1 Elements in the Shortcuts bar

- **Presets:** [Presets](#) define the layout of the channels on a video wall. When a new preset is taken to air, it triggers a transition from the current layout to the new layout. New presets are created using the [Video Wall Designer](#).
- **Filled Presets:** A [Filled Preset](#) is a preset which also includes content. When a filled preset is taken to air, it populates the preset with content and plays out everything at once. Presets are filled with content using the [Preset Content Editor](#).

⚠ Note:
If a video wall group is partly filled, the empty GFX channels will still have the old contents.

- **Backgrounds:** Basic elements which load different scenes into the back layer of the video wall Engine. They need to be pre-assigned to the right channel and the right Viz layer so that they run in the back layer (this can also be set in the scene in its control object plugin).
- **Elements:** Images, videos and graphics.
- **Activate** the Shortcuts bar by selecting a Shortcuts Playlist in the **General Tab** of the Settings window.

Items in the Shortcuts Bar can be **armed** by clicking them, similar to arming channels.

Shortcut menus in the Shortcuts Bar

Access two context menus by right-clicking elements in the Shortcuts Bar. The options in each menu change depending on the type of media you are right-clicking.

The two context menu types are:

- Shortcut menu for presets
- Shortcut menu for elements

Shortcut menu for presets

Right-click a preset in the Shortcuts Bar to expose the following context menu:

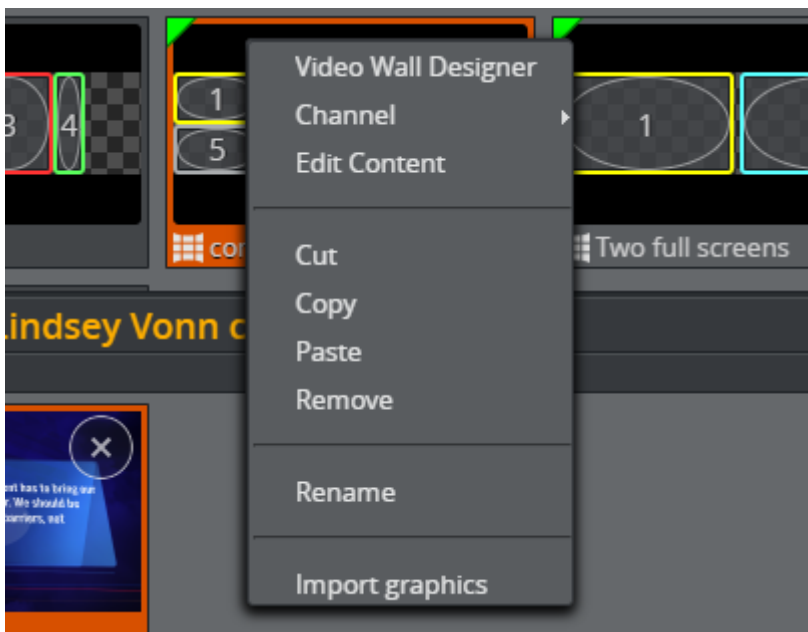

- **Video Wall Designer:** Open the [Video Wall Designer](#)
- **Channel:** Change the playout channel of the preset. The main renderer is normally called "A".
- **Edit Content:** Open the [Preset Content Editor](#)
- **Cut:** Cut a preset and paste it in another tab/column.
- **Copy:** Copy a preset and paste it in another tab/column.
- **Paste:** Paste an element previously copied or cut.
- **Remove:** Remove the preset from the Shortcuts Bar.
- **Rename:** Rename the preset.

- **Import graphics:** Import graphics from the Graphic Hub directly into this group.

Shortcut menu for elements

Right-click an element (video, image or graphic) in the Shortcuts bar to expose the following context menu:

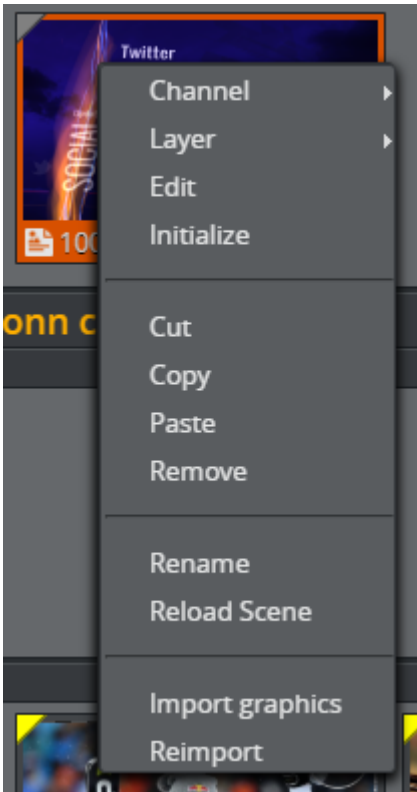

- **Channel:** Change the playout channel of the element
- **Layer:** Change the Viz Engine layer (BACK, MAIN, FRONT). See [Layers](#)
- **Edit:** Open the corresponding element editor.

Note

The image editor is only available for images assigned to a GFX channel.

- **Initialize:** Load the resources for this element into the renderer. Should be used with care. It may affect renderer performance.
- **Cut:** Cut a preset and paste it in another tab/column.
- **Copy:** Copy a preset and paste it in another tab/column.
- **Remove:** Remove the element from the Shortcuts Bar.
- **Rename:** Rename the element.
- **Reload Scene** (only for graphics): Makes the renderer reload the scene from the Graphics Hub.
- **Import graphics:** Import graphics from the Graphic Hub directly into this group.
- **Reimport** (only for graphics): Re-import the graphics from the Graphic Hub. Does not affect the renderer. Useful if the scene designer has added or removed control fields.

4.9.2 Layers

Use different layers to show up to three elements on screen simultaneously. Play elements in the default, FRONT, MAIN and BACK layers (defined below).

The selected layer will determine the element's position (whether or not it's visible) in relation to other elements.

✓ **Tip:**
Set layers in the [Shortcut menu for elements](#).

- **default:** Revert to the layer that is set by the scene designer.
- **FRONT:** Front layer elements cover main and back layer elements, i.e. this layer will never be obstructed.
- **MAIN:** The middle layer where elements cover back layer elements.
- **BACK:** The first layer than be used as a background for a videowall. Front and back layer elements will overlap it.

See Also

- [Presets](#)

4.9.3 Working with the Shortcuts Bar

This section covers the following:

- Add a shortcuts group
- Delete a group from the shortcuts bar
- Rename a group
- Reposition a group in the Shortcuts Bar

Add a shortcuts group

Add a group to the playlist you have chosen to appear in the shortcuts bar. Groups created via the shortcuts bar appear in the show pane when no shortcut playlist is set.

1. Click the **Add (+)** button in the Shortcuts Bar.

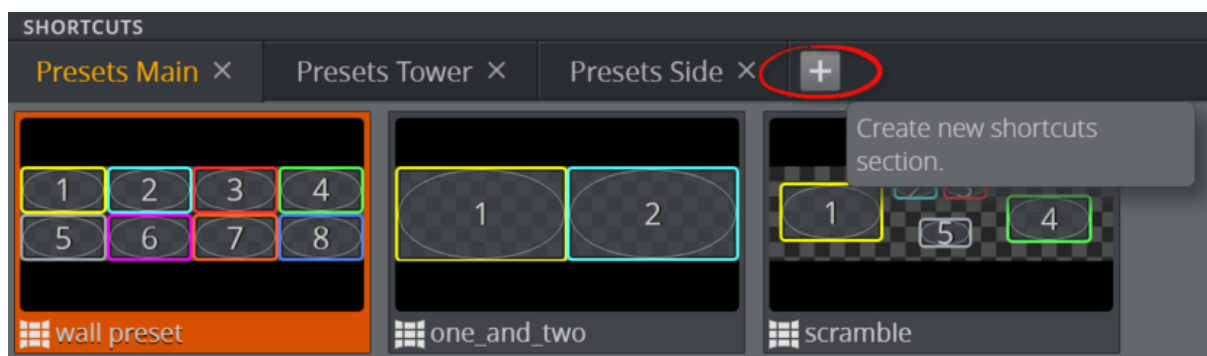

2. Give the new group a title.
3. Click **OK**.

Delete a group from the shortcuts bar

Delete playlist groups from the shortcuts bar.

1. Click the close button in the top right corner of the shortcut group tab.

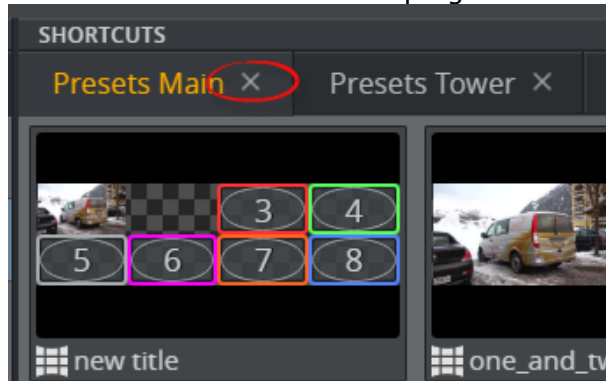

2. Click **Yes**.

Rename a group

1. Double-click the group's title.

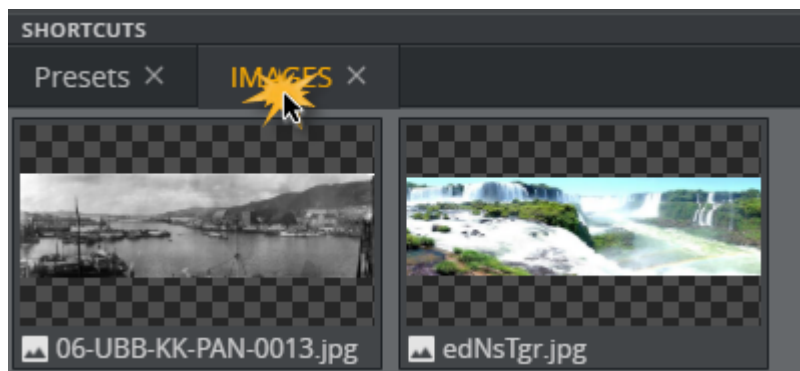

2. The title field becomes editable.
3. Enter a new title in the field and press **ENTER** to confirm the change.

Reposition a group in the Shortcuts Bar

1. Click and drag the group to the desired position in the top groups.

4.9.4 GFX preset mode

GFX preset mode exposes a filled preset's main and graphics (GFX) channels by pressing **SHIFT**.

The following sections cover GFX preset mode and its advantages, plus an example GFX preset mode workflow:

- Two modes
- How do I activate GFX preset mode?
- Example workflow

Two modes

The shortcuts bar has two modes: thumbnail mode and graphics (GFX) preset mode. By default, the shortcut bar is in thumbnail mode. This means only item thumbnails in a preset will show in the program (on-air) column, as shown here:

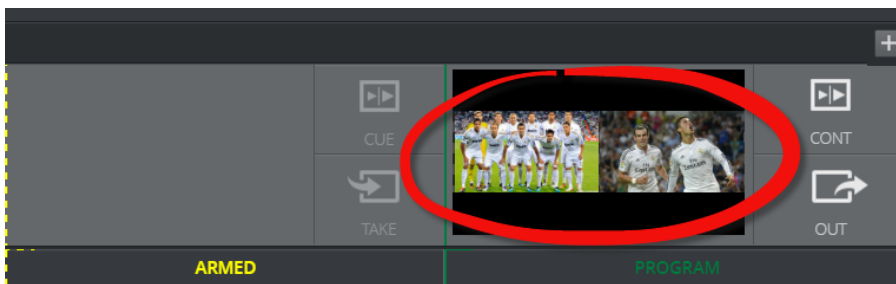

You may, however, need to know the following:

- which main channel your presets are playing out on; and
 - which GFX channel an item in a preset is playing out on.
- This information is available in GFX preset mode, which provides:
- a visual confirmation that presets are being sent to the desired wall; and
 - assistance when replacing content in a GFX channel.

How do I activate GFX preset mode?

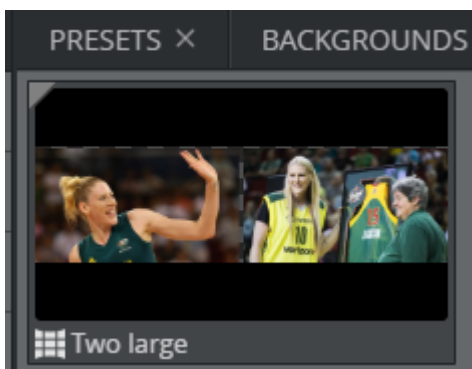

Press **SHIFT** when Multiplay is in focus. Once GFX preset mode is activated, small green icons appear in the bottom corner of a preset or item thumbnail showing the main channel the GFX channel number:

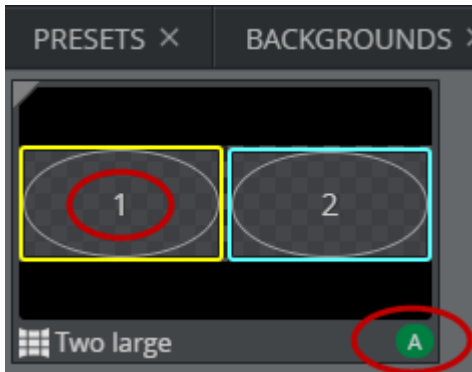

Note:
These icons only appear for items and presets in the shortcuts bar.

Example workflow

In this workflow, activate GFX preset mode to see which GFX channel hosts a picture you want to replace.

1. Take a filled preset to air from the shortcuts bar.
 - a. Click the preset to move it to the Armed column.
 - b. Click it in the Armed column to move it to the Program column.



2. By default the thumbnails appear in the preset in the program column, and there is no visual indication which GFX channel they are playing out on.

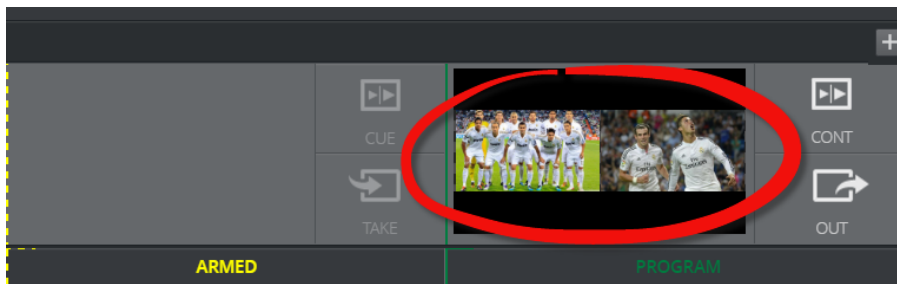

3. Press and hold **SHIFT** to see the preset's main and GFX channels. The thumbnails are replaced with the GFX channel number. This preset is playing out on wall A and has images in GFX1 and GFX2.



4. Now, if you want to replace the team photo with another image, you know you must replace the photo in GFX1.
5. Drag an image from any channel into GFX's program channel.

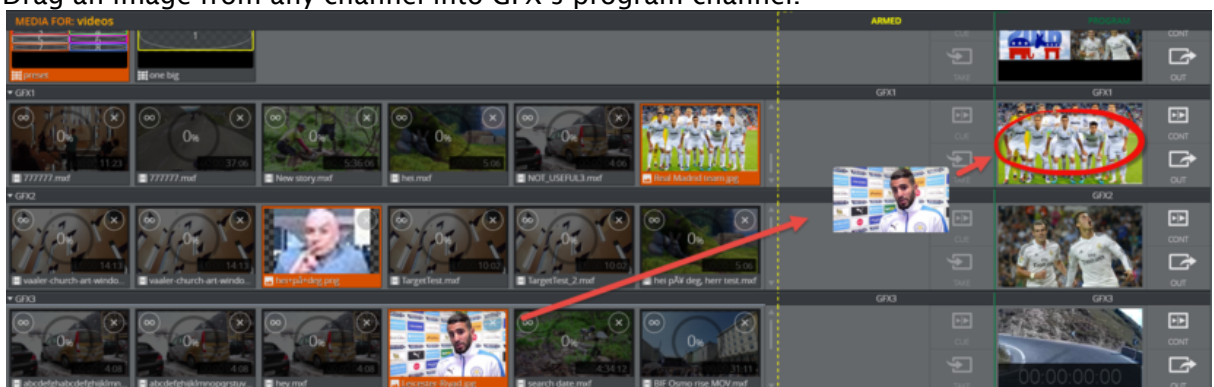

✓ **Tip:**
 Drag an image into a program channel from any channel. This means that the image in the program column for a certain GFX channel can be exchanged with an image from any other channel.

⚠ **IMPORTANT!**
 The new image will not appear in the **Filled Preset** in the shortcuts bar. A video wall set up is required to see it live on air in the filled preset.

4.10 Status And Logs

4.10.1 Status Bar

Display the Status bar by selecting **Show status bar** in the [Settings](#) window.

When minimized the Status bar shows the latest status message.

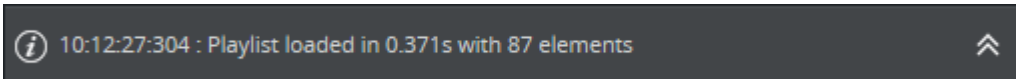

4.10.2 Logs

Click **Expand**  to show the Log Messages pane.

Message can be filtered by type (Messages, Warnings, Errors) or download them into a file using the **Save log** button. Logs can be deleted by clicking **Clear log** tab.

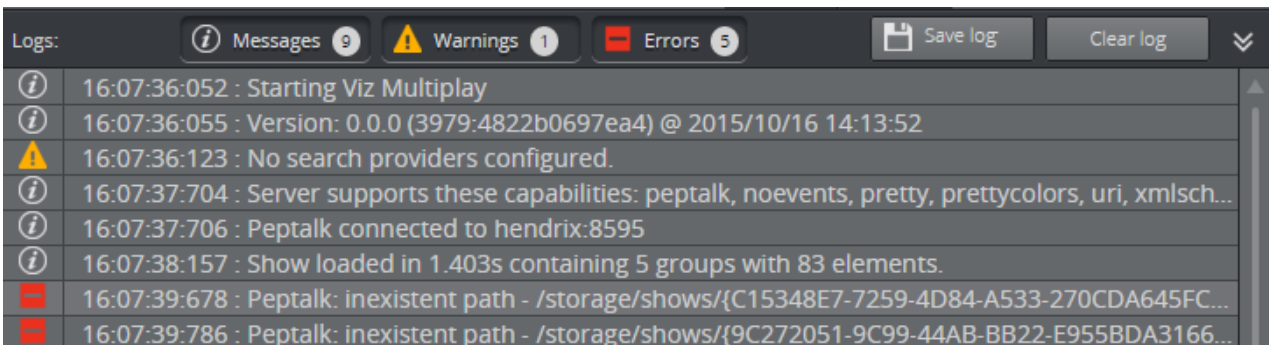

4.10.3 Version Information

Scroll to the beginning of the log messages to find the Viz Multiplay version information.

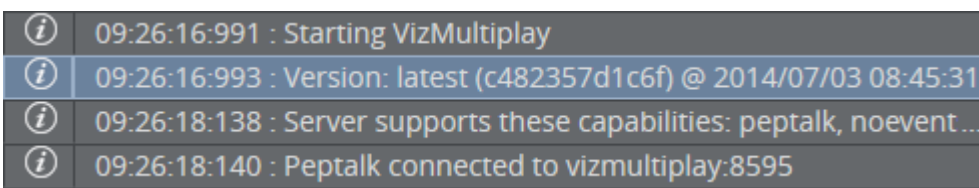

See Also

- [Troubleshooting and Common Issues](#)

4.11 Editing Graphics, Videos And Images

Once items have been added to the [Media Column](#) in a story, they can be edited (right-click the item and select **Edit**).

The editing options depend on the type of media:

- [Editing Images](#)
 - [Image Effect Editor](#)
- [Editing Videos](#)
 - [Open the video editor](#)
 - [Video timeline editing options](#)
- [Editing Graphics](#)
 - [Fill In Form](#)
 - [Preview Window](#)
- [Editing Presets](#)
 - [Preset](#)
 - [Filled Preset](#)
- [Renaming playlist entries](#)
 - [Rename from the context menu](#)
 - [Rename from the Editor](#)



Note:

The image editor is only available for images in GFX channels.

4.11.1 Editing Images

Use the Image Effect Editor to crop an image or add a zoom/pan animation.

Image Effect Editor

To open the editor, right-click an image and select **Edit**.

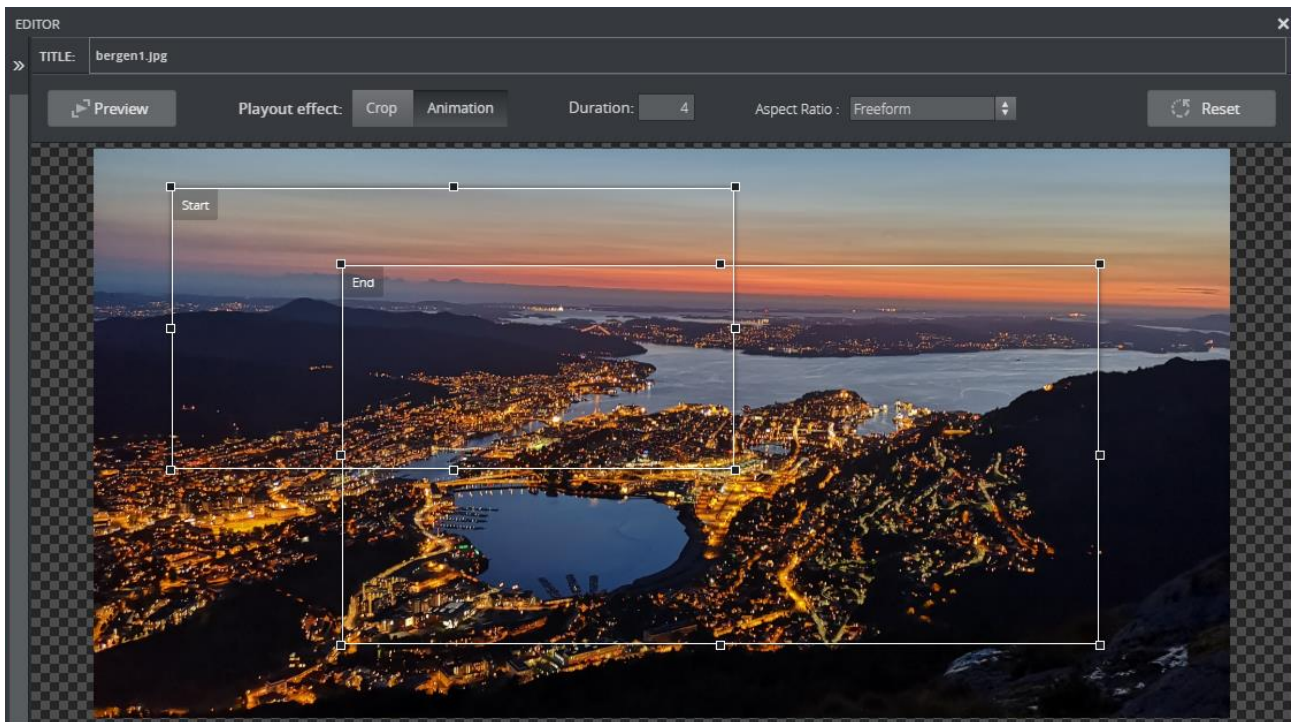

The Image Effect Editor allows you to crop or animate an image instantly using a crop rectangle. By default, the crop rectangle matches the image's aspect ratio, but you can also freely set the rectangles' aspect ratio.

- To **crop** an image, drag the rectangle to the desired size.

Tip:
Hold **Ctrl** before dragging the crop rectangle to maintain the current aspect ratio.

- To **animate** an image, select a start and end frame and a duration for the animation. Preview the animation using the **Play/Stop** button.

Note:
All changes are live and cannot be canceled.

Note:
The image editor uses a proxy image, so the image may differ slightly when played out on a Viz Engine.

- To force a different aspect ratio of the rectangles, select a value from the **Aspect Ratio** list. The values in brackets are:
 - **Freeform:** Freely set the aspect of the rectangles.
 - **Image:** Aspect is locked to the aspect of the image.
 - **GFX Channel:** For filled presets - the aspect is locked to the aspect of the GFX channel the image is assigned to.
 - **Profile Channel:** Locks the aspect to the aspect set on the channel in the [profile configuration](#).

- Click the **Reset** button to reset applied effects to the default settings.

4.11.2 Editing Videos

Use the Video Editor to edit videos in GFX channels.

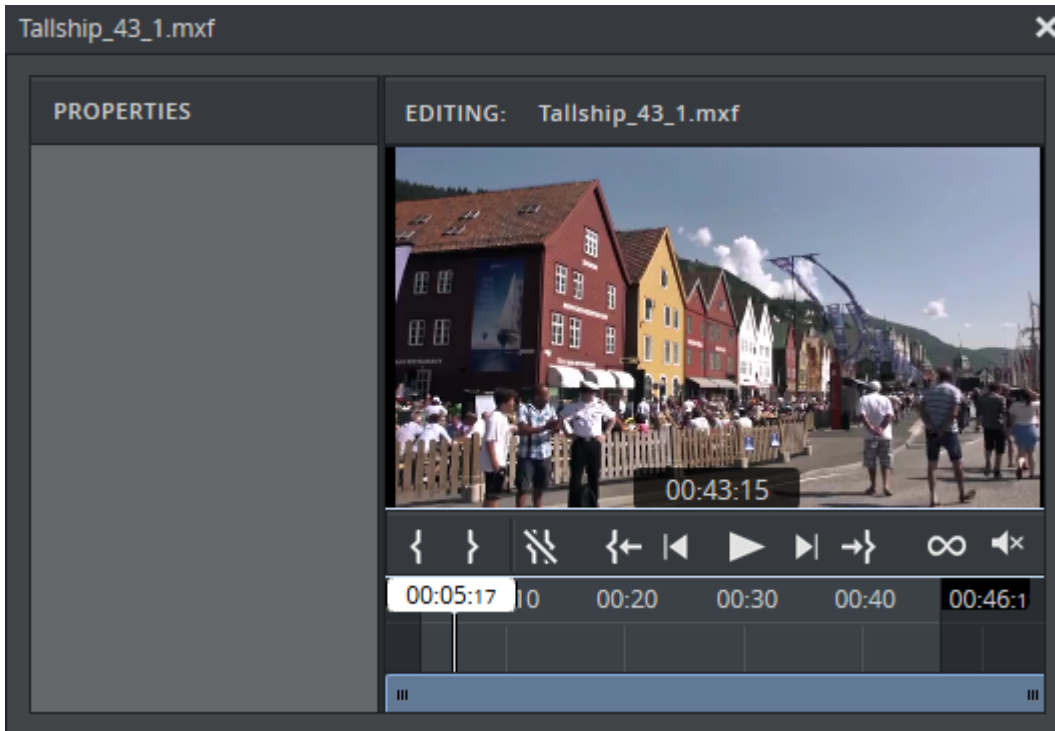

Open the video editor

1. Right-click a video in a channel in the Media Column or in the Shortcuts Bar.

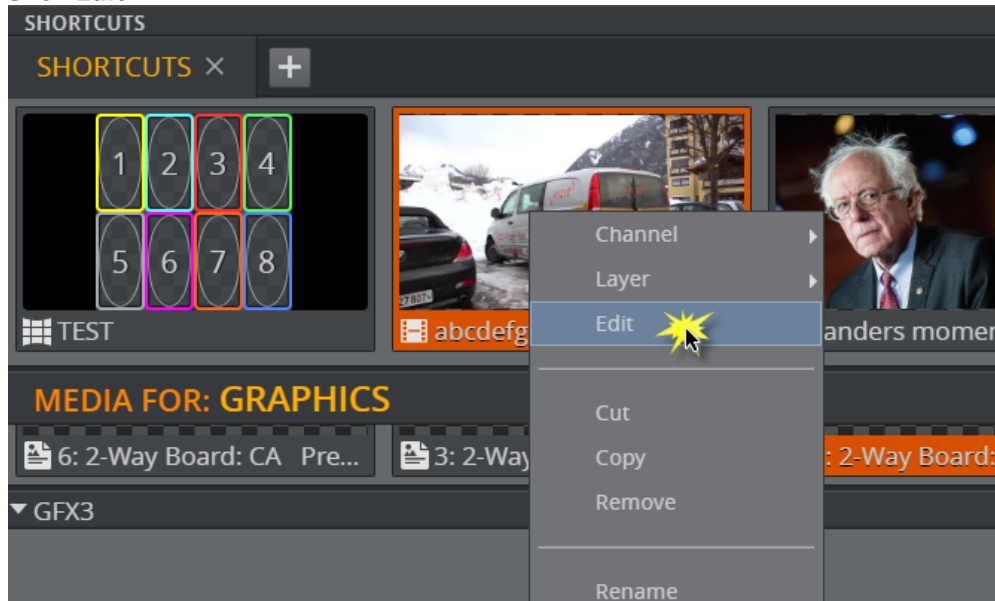
2. Click **Edit**.

- ✓ **Tip:** Double-click a video in the Shortcuts Bar or Media Column to open the [Image Effect Editor](#). However, double-clicking to open the editor only works in Offline Mode.

Video timeline editing options

The following buttons are available for video editing:

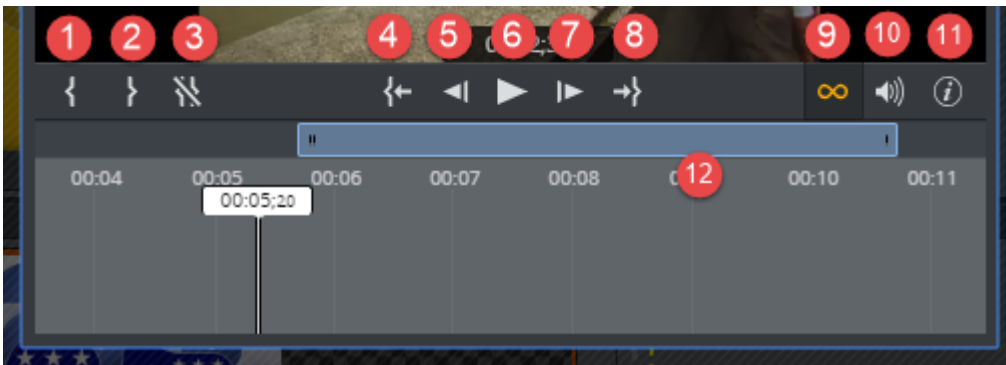

1. **Set Mark In:** Set an in point (I).
2. **Set Mark Out:** Set an out point (O).
3. **Clear Mark In/Out:** Clear in and out points (Shift + C).
4. **Go to In point:** Sets the playhead at the in point (Shift + I).
5. **Move 1 frame back:** Move the playhead one frame back (, -comma).
6. **Play/pause:** Play/pause the video (Space or Ctrl + Space).
7. **Move 1 frame forward:** Move the playhead one frame forward (. -period).
8. **Go to Out point:** Sets the playhead at the out point (Shift + O).
9. **Loop video:** Enable looping (R).
10. **Volume slider:** Adjust the clip volume (M to mute/unmute).
11. **List of the keyboard shortcuts** (Shift + K).

12. **Zoom and pan:** Click and drag the edges of the blue bar to zoom and move it to pan the timeline.

4.11.3 Editing Graphics

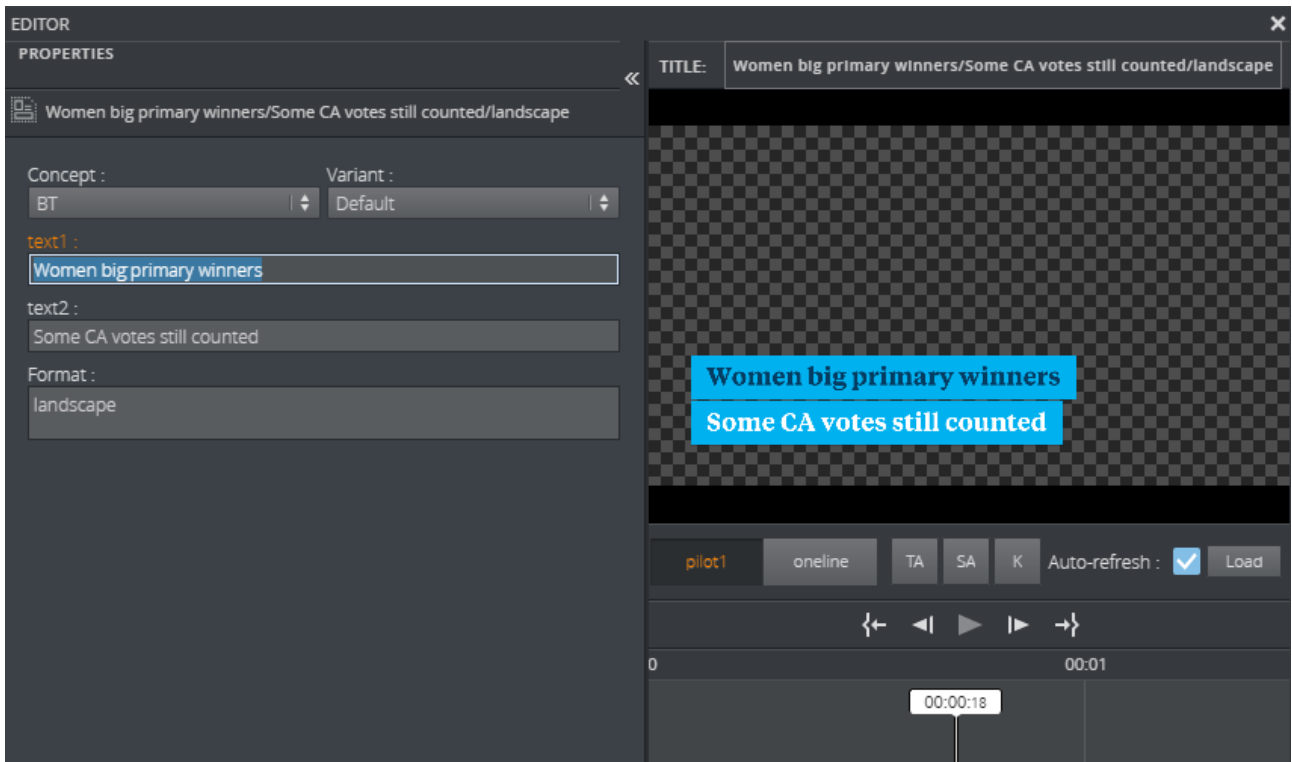

Open the Graphics Editor by right-clicking a graphics element and selecting **Edit**. Any changes made inside a graphical element are visible immediately.

On the left is the [Fill In Form](#), where you can edit the fields that are available in the graphical element.

On the right, there is a [Preview Window](#).

Note:
All changes are live and cannot be canceled,

Fill In Form

The window to the left is a Fill In Form for the graphics. It displays fields that are exposed by the designer in Viz Artist where the user can add content to the graphic. It can be text, choices in a drop-down list or media placeholders for media assets. Once changes are made in the Fill In Form, the Preview Window immediately updates to display them (as long as **Auto-refresh** is toggled on).

Custom HTML

The Fill In Form in Viz Multiplay is auto-generated based on the fields in the Viz scene. To change the appearance of the form, it is possible to replace the complete or parts of the form with your

own custom HTML. This is an advanced feature, but the end result is that the user (the journalist or whoever fills in information) is exposed to a completely customized interface. To use this feature, see [the Template Builder manual](#).

Maps

Maps from Viz World can be used in the Fill In Form if the graphics contains a **Map** field, which can be set in [Template Builder](#) version 1.0.2 and later. A Map field is generated when the Viz scene contains a map plugin.

Once there is communication with a Viz World server the user can select from a list of available maps in Viz World. In order to edit these maps, a local Viz World installation is required. Since Viz World only runs on Windows, the Map Editor is only available when Viz Multiplay is running on Windows machines.

Viz World Configuration

Viz World must be configured in a Pilot Data Server to establish communication between Viz Multiplay and Viz World.

In the Pilot Data Server Web Interface go to the *shared_curious_server* parameter (see the Database Parameters in the [Viz Pilot guide](#)) through Settings and add a hostname in the value column.

In the value column, use either:

- hostname or IP

or,

- full URL. Here the port must be defined

i Info

A Viz World server defined in the Viz Multiplay URL (maps=mapshostname) will override the server defined in the Pilot Data Server.

Choosing Maps

To select a map, click **Choose map** in the Fill In Form.

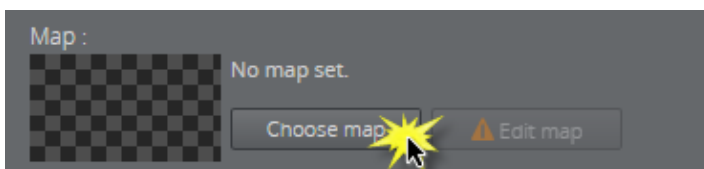

A dialog appears including the maps that are available from the Favorite folder in the Viz World Map Editor.

Select a map.

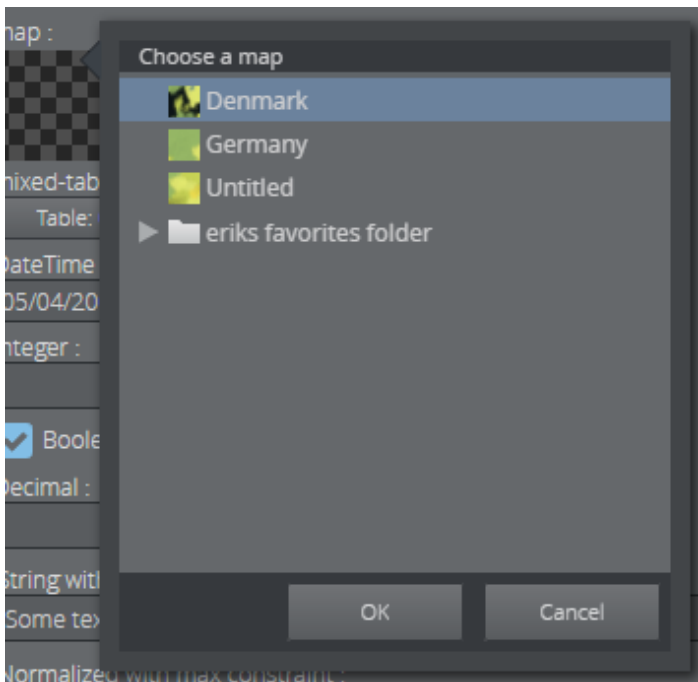

The map appears in the thumbnail in the Fill In Form and in the graphic in the preview window. Using this feature of choosing a map only requires communication with a Viz World server. However, a local Viz World installation is required to edit maps. See below.

Edit Maps

The **Edit map** button is enabled only when a Viz World client 17.0 or higher is installed on the computer running Viz Multiplay, and the Map Client service is running. Normally the service is located here:

C:\Program Files\Vizrt\Common\Maps\MapClient.Service.exe

- Double click this file. A window pops up and closes, and now the service is running.

Once a map is chosen and there is a running Map Client on the machine, the map can be edited. Click **Edit map**.

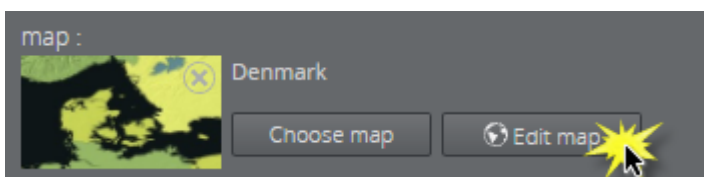

This opens up the Viz World Map Editor. All edits are performed inside this client, which means that Viz Multiplay has no control over your actions here.

After the map has been opened in the Map Editor the name is changed to e.g. *Denmark [modified]*, indicating that the map has been edited.

To cancel the edit mode, click **Cancel edit**.

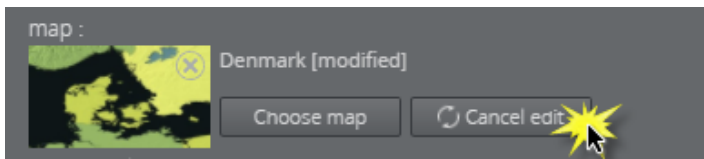

WARNING

Clicking outside the Viz World Map Editor while it is open hides the window behind the Viz Multiplay window. Viz Multiplay will keep listening for data coming from Viz World until the window is closed. Recover the Map Editor from the taskbar and close it, or click **Cancel edit** from Viz Multiplay.

The map thumbnail view will not be available after saving and re-opening a template including a map, however, the map will still be there. Once the Viz World Map Editor is opened and communication is established, the map thumbnail view is available.

The Preview Window will update according to the selected map and edits performed on it.

Warnings

Warning signs and grayed out map buttons indicate that the Viz World service is unavailable or that there is an error from the service.

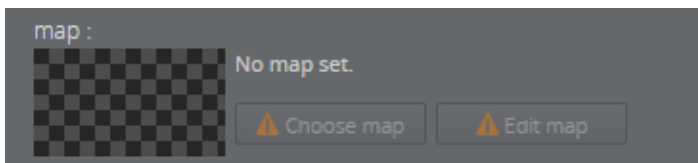

If no map is chosen or no default value is found, the **Edit map** button will be grayed out with a warning sign. A map has to be chosen before edits can be made.

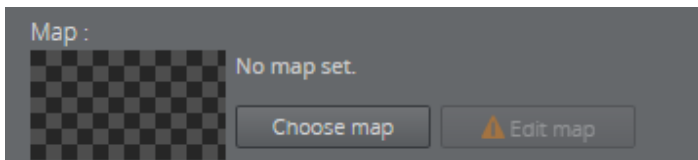

If a map is chosen, but the **Edit map** button is still grayed out, the map client is not detected.

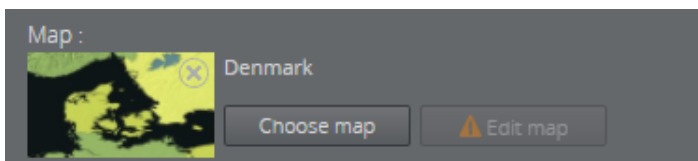

Feed Browser

If a graphic template contains a **Browse** button in the Fill In Form, the user can browse for a feed entry. The feed entry URL is pre-set in the template. Use **Template Editor** to change a field type from pure text to a Browse button linked to an Atom feed, or a dropdown with fixed choices.

Using the Feed Browser in the Fill In Form for a graphic is shown below:

1. Click the **Browse** button to open the Feed Browser.

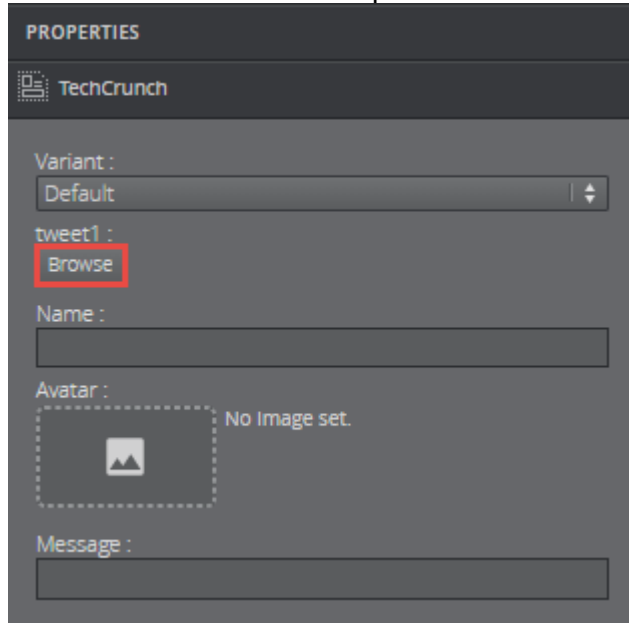

2. The Atom entries of the feed will be presented as thumbnail if available. Select one of the entries and click **OK**.

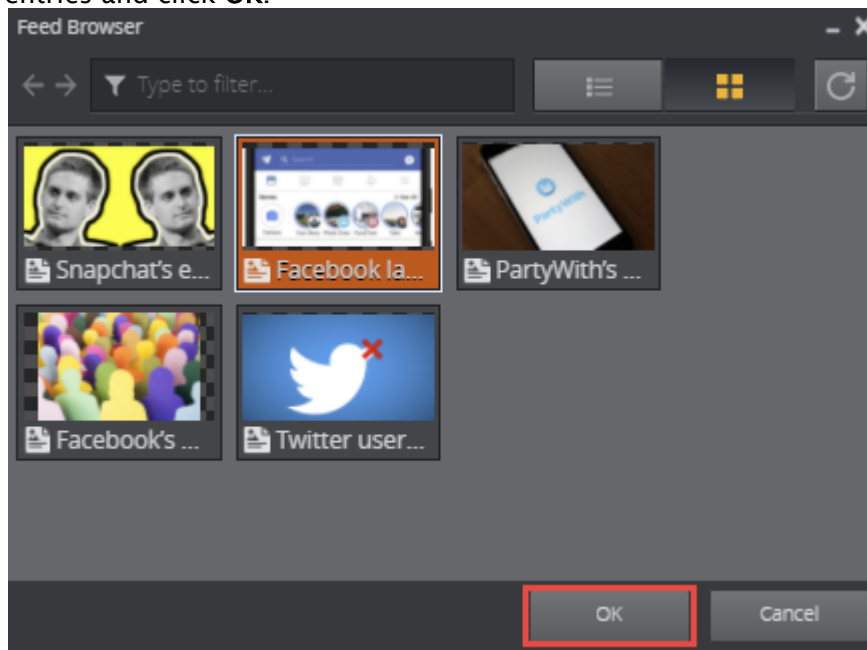

3. Information from the entry will be used to fill in the feed browser fields in the template.

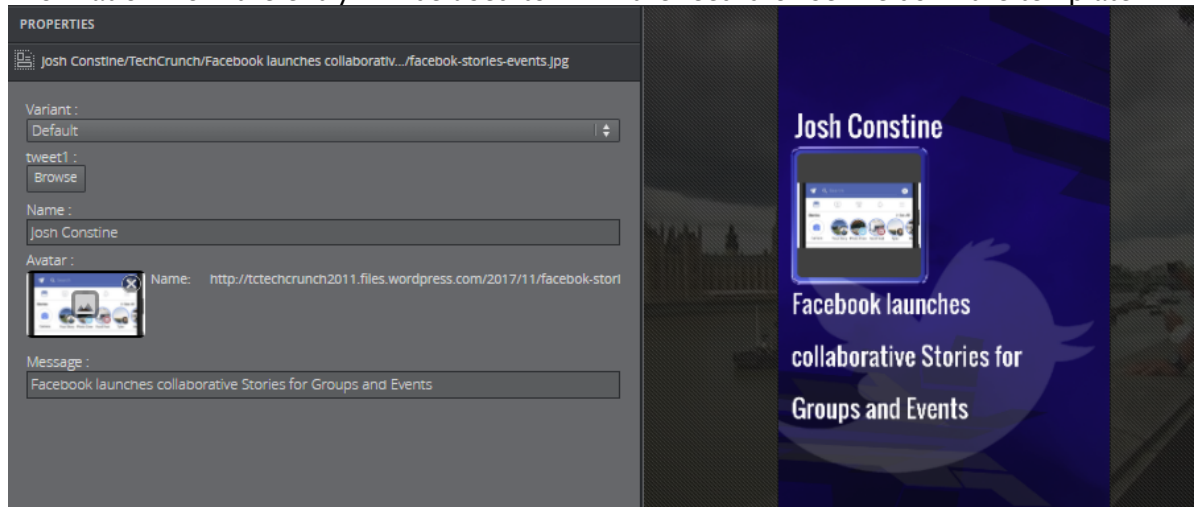

Preview Window

The Preview Window displays snapshots of the graphics and provides the user with an idea about how the graphics will look when played out in high resolution on a Viz Engine. The Viz Engine generate snapshots requested by the Preview Server. These are the functions of the Preview Window:

- **TA:** Show/hide the Title Area in the edit window.
- **SA:** Show/hide the Safe Area.
- **K:** Show the key signal for the graphics.
- **Preview points:** If the scene contains named preview points, such as stop points and/or tags in the director called **Default**, these are shown as buttons on the toolbar. If there is not enough space for the buttons, they appear in a drop-down list instead. Selecting a preview point shows a preview of the scene at the given point, and the playhead jumps to the point in time where the preview point is set.
- **Scrub** the timeline back and forth by clicking on it or moving the playhead. If the scene does not have a director called **Default**, or the **Default** director does not have a duration, the timeline will be disabled.
- **Auto-refresh:** Auto-refresh is located at the bottom of the Preview Window and is by default toggled on which means that the Preview Window updates once there are any changes in the Fill In Form.
Toggle off **Auto-refresh** to turn this functionality off. To refresh the Preview Window in this mode click the Refresh button  Auto-refresh : or click inside the Preview Window.
- **Load:** Clicking this button will load the animation of the graphics. Once loaded, indicated by a green line at the bottom of the timeline editor, media controls appear allowing for

controlling the graphics animation in the Preview Window:

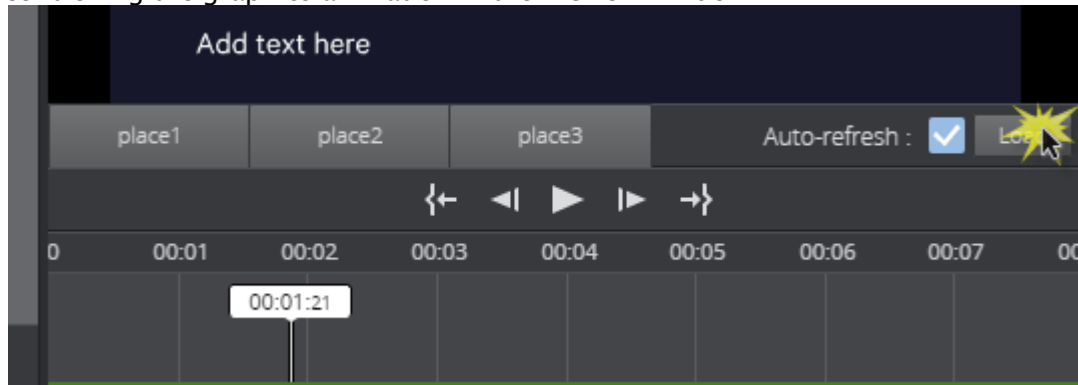

WARNING
The load animation feature will send a lot of snapshot requests to the Preview Server, so if many people do this at the same time it could result in performance issues.

4.11.4 Editing Presets

There are two types of presets, [Presets](#) and [Filled Presets](#), each with their own editing options.

Preset

A Preset defines the layout of the graphics channels on a video wall.

New presets are created in the [Videowall Tab](#). Drag presets to the [Shortcuts Bar](#) in order to switch between layouts during a broadcast and send presets to air.

This section covers the following:

- Create a preset
- Send a preset to air
- Open the Video Wall Designer

Create a preset

Add a new videowall preset.

1. Click the [Videowall Tab](#) in the [Sources Pane](#).
2. Click the + icon.

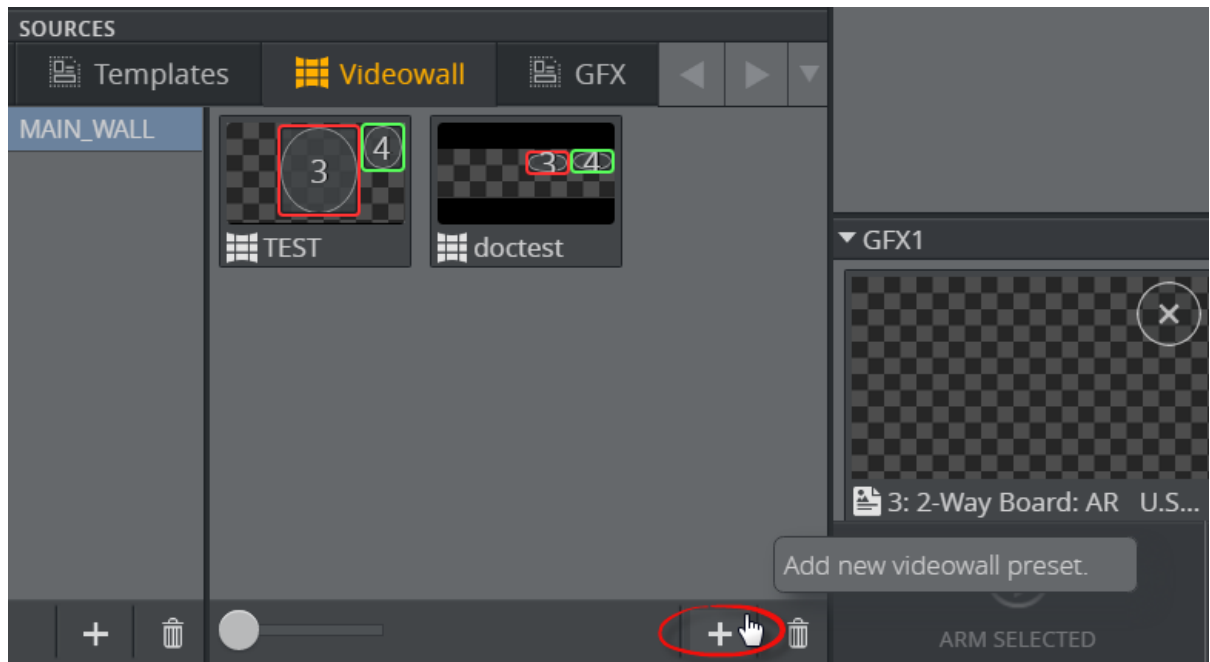

3. Give the preset a title.

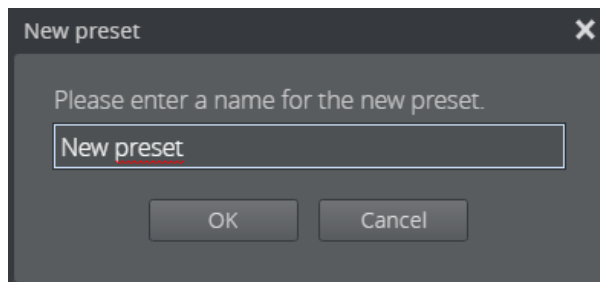

4. Click **OK**.

Send a preset to air

Send a preset to air via the Shortcuts Bar.

1. Drag a preset to the Shortcuts Bar.

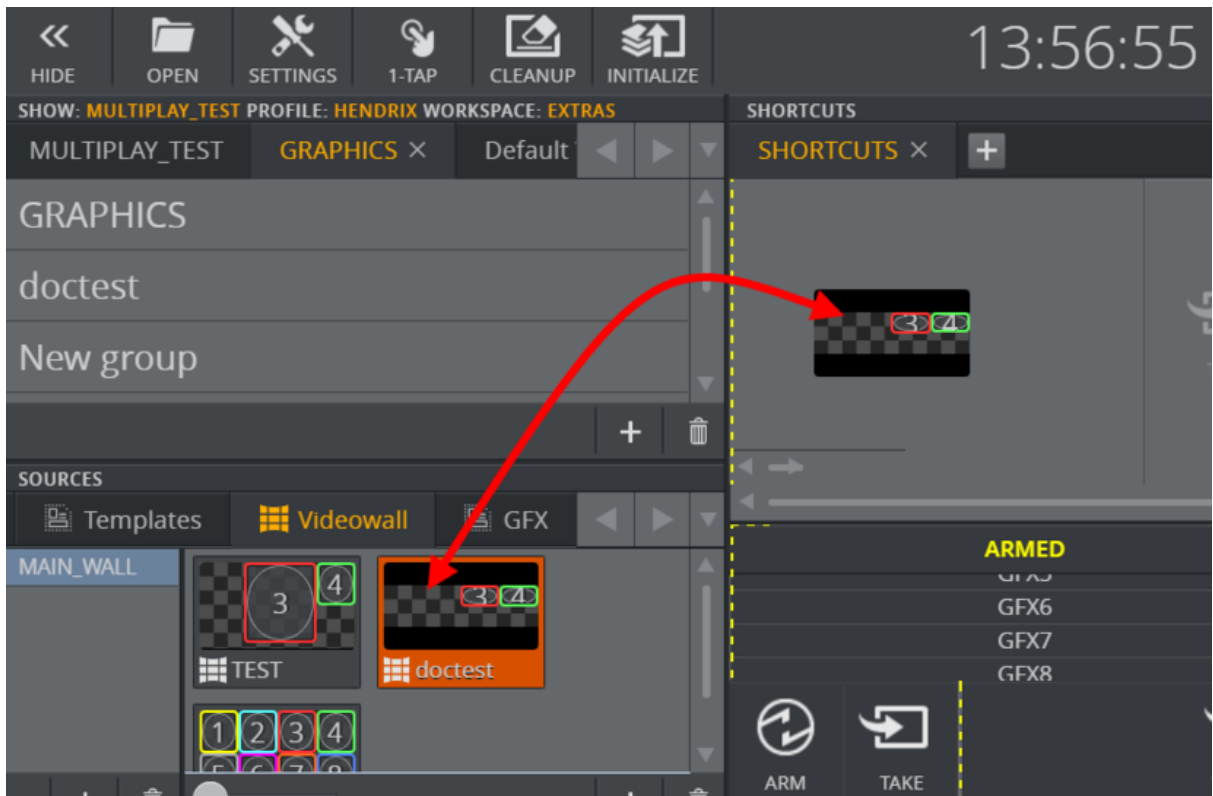

2. Click the preset to send it to the **Armed** column.

Note:
In **1-Tap Mode**, clicking a preset will send it straight to on air.

3. Click the preset in the Armed column, or click the **Take** button.

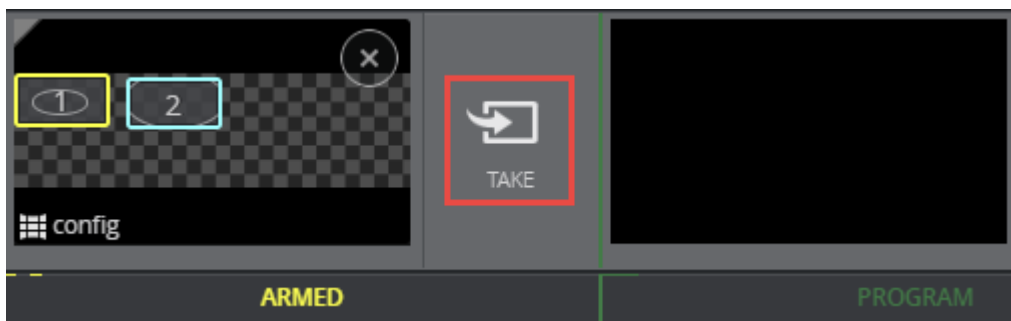

4. The preset moves to the to the **Program** column and is now on air.

Open the Video Wall Designer

Edit the preset layout in the **Video Wall Designer**. There are two ways to access the Video Wall Designer, as described below:

Access the Video Wall Designer via the Videowall Tab:

1. Right-click a preset in the Videowall Tab.

2. Click **Video Wall Designer**:

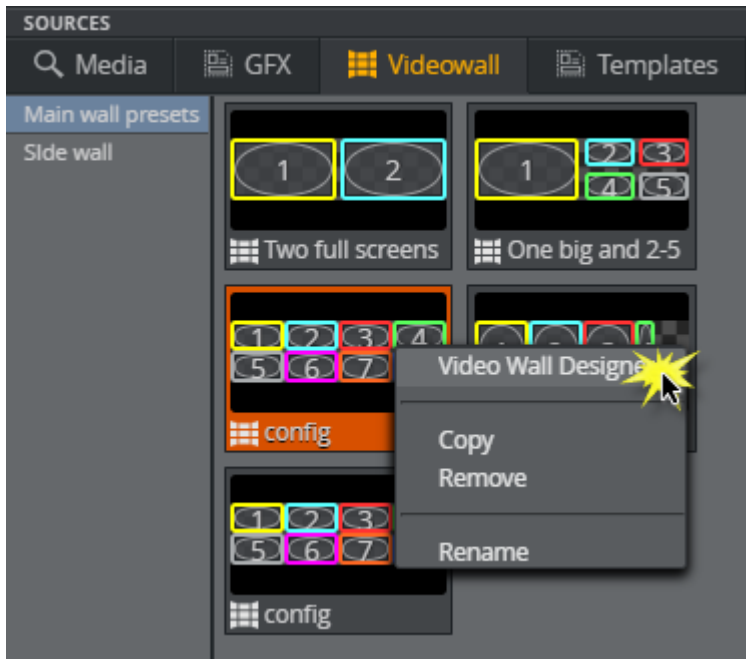

Access the Video Wall Designer via the Shortcuts Bar:

1. Right-click a preset in the Shortcuts Bar.
2. Click **Video Wall Designer**:

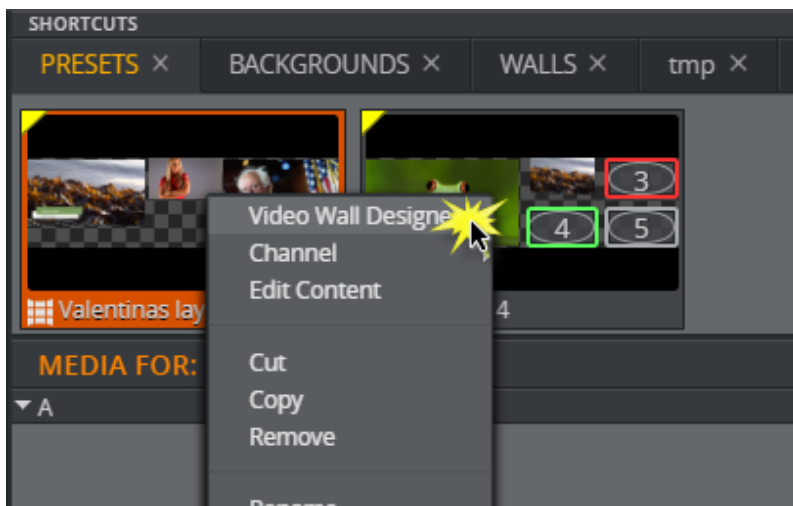

Filled Preset

A Filled Preset is a video wall layout which also includes predefined content. Use Filled Presets to send content onto your video wall quickly. Content can only be added to presets which are in the [Shortcuts Bar](#).

Edit the content in a preset in the [Preset Content Editor](#) (right-click a preset in the Shortcuts bar and select **Edit Content**).

See Also

- [Using your new presets](#)

4.11.5 Renaming playlist entries

There are two ways to rename media items added to a playlist in the [Shortcuts Bar](#) or [Media Column](#):

- [Rename from the context menu](#)
- [Rename from the Editor](#)

Rename from the context menu

1. Right-click an item in either the Shortcuts Bar or Media Column.
2. Click **Rename**.

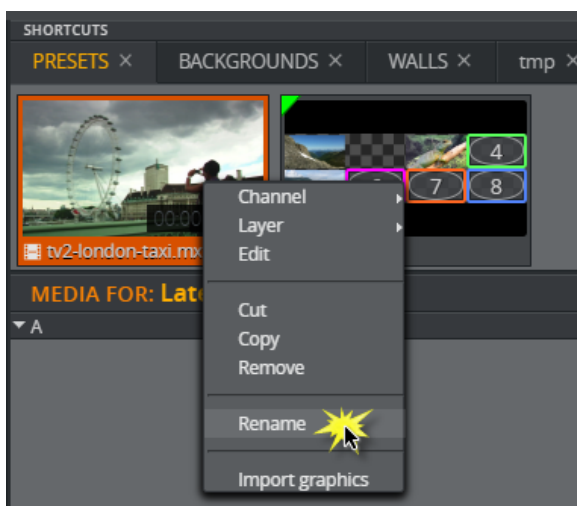

3. Enter a new title and click **OK**.
4. The new title is shown on the element.

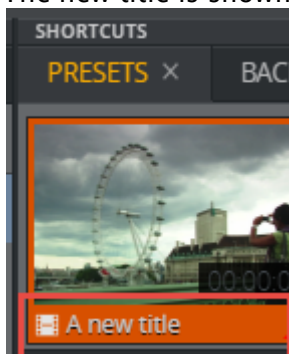

Note:
The new name will not be overwritten by the auto-generation process when entering new field values in the Editor.

Rename from the Editor

1. Right-click an item in the Media Column.
2. Click **Edit** to open the Editor.

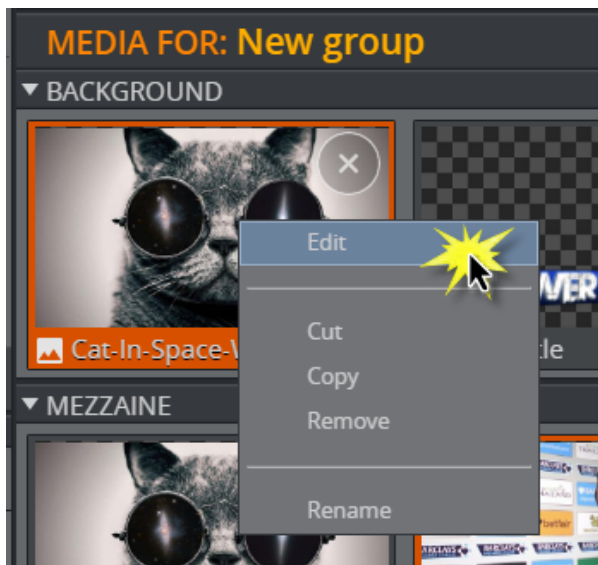

3. Click the title text field.

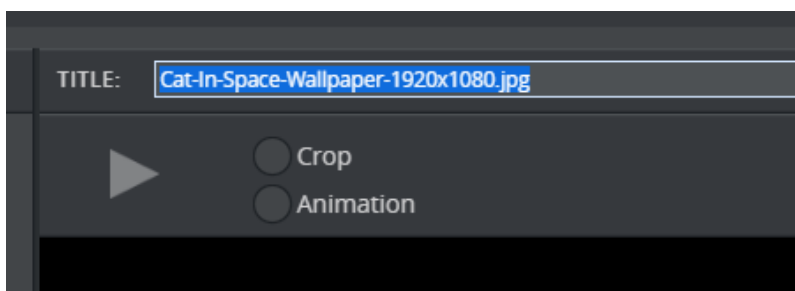

4. Enter a new title.
5. Press **ENTER**.
6. Click **x** to close the editor. The element is shown in the Media Column with the new title.

4.12 Keyboard Shortcuts

There are different keyboard shortcuts available depending on where in Viz Multiplay you are. The different areas where you can use keyboard shortcuts are:

- [Main window](#)
- [Profile Configuration](#)
- [Video Editor](#)
- [Workspaces](#)
- [Video Wall Designer](#)

4.12.1 Main window

Clicking this button will display a window with all the available keyboard shortcuts in the [Main Window](#) in Viz Multiplay:



Shortcut	Action	Comment
A, [number]	Arm on channel.	Arm the currently selected or first element on the channel. If in 1-Tap mode, do nothing.
T, [number]	Take on channel.	If in 1-Tap mode, take the currently selected/first element on the channel. If not in 1-Tap mode, take the armed element.
C, [number]	Cue armed element on channel.	Cue the currently armed element. If in 1-Tap mode, do nothing.
Alt + T	Take all armed or selected elements.	Depends whether 1 tap mode is enabled or not. If enabled, the key press will take all selected elements, and if not, all armed elements will be taken.
Alt + C	Cue all armed elements.	
Alt + U	Unarm all armed elements.	
P, [number]	Continue current element on channel.	Continue the currently running element(s).
O, [number]	Out the current element on channel.	Take OUT the currently running element(s).
Alt + P	Continue all elements in the Program channel.	

Shortcut	Action	Comment
Alt + O	Out all elements in the Program channel.	
Shift + R, [number]	Re-Cue the current video on channel.	Re-cue the video element currently set on the channel.
Shift + P, [number]	Pause the current video on channel.	Pause the currently playing video on the channel.
Shift + V, [number]	Play the current video on channel.	Play/continue the currently cued/paused video on the channel.
Shift + C	Collapse all channels.	
Shift + E	Expand all channels.	
Shift	Reveal channels.	Hold the shift key to reveal GFX channels under the filled presets, or show which channel the shortcuts elements are assigned to.
Enter	Take or Arm the selected element.	
Delete	Delete the selected item.	
F2	Rename group.	

The **[number]** in the above table refers to the index of the visible channels in the Multiplay GUI. The first visible channel has shortcut key 1, the second visible channel has shortcut key 2 etc. This means that if the GUI contains two channels A and B. A has shortcut key 1 and B has 2.

Note that [number] should be typed without any modifiers (Ctrl, Shift, ALT etc.), and in case the combination is a key and a number, the key must be pressed and released, followed by the number. These are to consecutive key presses, and not a simultaneous key press combination.

4.12.2 Profile Configuration

The following keyboard shortcuts are related to the **Channels** list in the **Profiles** tab in the [Settings](#). Click a channel and apply the shortcuts to reorder channels.

Shortcut	Action
Ctrl + Arrow up	Move a channel up in the list.
Ctrl + Arrow down	Move a channel down in the list.

4.12.3 Video Editor

The following keyboard shortcuts are available when previewing a video from the [Video Editor](#) window:

Shortcut	Action
,	Move 1 frame back
.	Move 1 frame forward
M	Mute
I	Mark In
O	Mark Out
Shift + I	Go to In point
Shift + O	Go to Out point
Shift + C	Clear In/Out points
J	Fast reverse playback
K	Pause
L	Fast forward playback
Space or Ctrl + Space	Play/Pause
Alt + J	Play backward at 0.5x speed
Alt + L	Play forward at 0.5x speed
Shift + J	Move 10 frames back
Shift + L	Move 10 frames forward
Shift + K	Keyboard shortcuts
Scroll wheel	Timeline zoom

4.12.4 Workspaces

In the Workspace Settings, you can assign your own keyboard shortcuts to switch between workspaces. To assign shortcuts, see [Shortcuts per workspace](#).

4.12.5 Video Wall Designer

In the [Video Wall designer](#), a help page for keyboard shortcuts is displayed when clicking the  button:

Shortcut	Action
←, ↑, →, ↓	Move selection
Shift + (←, ↑, →, ↓)	Move selection more
Ctrl + resize	Keep the aspect ratio when scaling
N	Enable/disable snap
Space	Enable/disable the pan tool
A	Enable/disable to keep the aspect ratio
Z	Zoom in
X	Zoom out
Ctrl + click	Select/deselect multiple options
Ctrl + Alt + click	Select behind current selection
Ctrl + F	Bring selection to the front
Ctrl+ B	Bring the selection to the back
Backspace or Delete	Delete selected items
Ctrl + Z	Undo
Ctrl + Y	Redo
Ctrl + S	Save changes
Ctrl + Shift + S	Save changes as

5 Tools

This section describes the following tools:

- [Video Wall Setup Tool](#)
 - [Video Wall Designer](#)
 - [Preset Content Editor](#)
 - [Studio Editor](#)
-

5.1 Video Wall Setup Tool

When setting up video walls with graphics channels, each graphics channel needs one Viz handler and one video handler. The Video Wall Setup tool allows you to add all the necessary handlers and channels in one step. You can also combine the video wall with manually created channels and handlers.

Open the New Video Wall Setup tool by going to [Viz Multiplay Settings](#) > [Profiles Tab](#) and clicking the **Add (+)** button at the bottom of the **Video Walls** pane.

This section contains the following topics:

- [Video Wall Setup Fields](#)
- [Clip Channels](#)
 - [Clip transitions](#)
- [Multi Video Wall Control](#)
- [External Preview](#)

5.1.1 Video Wall Setup Fields

The screenshot shows a 'New Video Wall Setup' dialog box with the following fields and values:

- Name: New Video Wall
- Merge Into: (None)
- Host or IP: localhost
- Asset Storage: vizengine for triovideo
- First GFX Port: 55000
- GFX Channels: 8
- Main Channel: B
- Channel Prefix: GFX_B
- Screen Rows: 2
- Screen Columns: 4
- Wall Offset Left: 0
- Wall Offset Top: 0
- Bezel Width: 0
- Bezel Height: 0
- Screen Width: 1600
- Screen Height: 900
- External Preview: (None)

- **Name** of the video wall
- **Merge Into:** Merge this video wall with other video wall to setup a *multi video wall control*. (See [Advanced Settings](#))
- **Hostname or IP** of the Viz Engine
- **Asset Storage:** Select the Viz Engine storage point to which the Viz One can send assets
- **First GFX Port** for the Viz Engine ports (eg. localhost:55000, localhost:55001, etc)
- **GFX Channels** to be created (1-16)

⚠ Note:
The number of graphics channels is not necessarily linked to the number of screens you have. The graphics channels are virtual, whereas the screens are the physical outputs on the video wall.

- **Main Channel** name of the main renderer.

- **Channel Prefix** for the sub-channels (eg. GFX1, GFX2, GFX3, etc)
- Number of **Screen Rows** and **Screen Columns** in the video wall. This should be the same configuration as Nvidia Mosaic on the Viz Engine host. If a video wall display controller like Datapath Fx4 is used to distribute the output to different screens, use 1 row and 1 column, and let the screen width and height be the same as the Viz Engine renderer output resolution.
- **Wall Offset Left** and **Wall Offset Top**: Define the relative position of this video wall compared to the main wall if using several Viz Engines combined in a _multi video wall setup _ (See [Advanced Settings](#)). Use the same units as you use for Bezel width/height and Screen width/height.
- **Bezel Width** and **Bezel Height** define the width/height of the bezel around a screen. That is, the distance between the edge of the video display area (screen) and the outer edge of the physical device.
- **Screen Width** and **Screen Height** define the total width/height of a particular screen or a video wall screen.
- **External Preview**: Armed elements are taken to air on the external preview video wall to check the appearance before sending it to the main wall. For more detail, see [External Preview](#).

See Also

- [Combine video walls](#)

5.1.2 Clip Channels

Viz Multiplay supports up to 16 clip channels, and will start at clip channel 1.

This may cause a conflict if you have a graphics scene which uses clip channels (for example, a butterfly scene which plays video clips inside the graphics using clip channels 1 and 2). If these scenes are played out on a GFX channel on the video wall at the same time as the clip channels inside the scene are used to play out content on the corresponding GFX channels, it creates a conflict.

The solution is to redesign the scene to use clip channel numbers that are higher than the highest GFX channel. For example, if you have 8 GFX channels in the video wall, the clip channels used in the scene should start at 9.

Clip transitions

If clip transition (fading between clips) is enabled, the Multiplay scene uses one additional clip channel per GFX channel. The best practice is then to reduce the number of GFX channels to not get in conflict with the alternate transition clip channels. For instance, if clip channel 16 is used as the second (alternate) clip channel for transitions n GFX1 - then GFX16 cannot be used to play clips. See also [Tricks and Hints](#).

5.1.3 Multi Video Wall Control

It is possible to control multiple Viz engine, video walls and screens with the Multi Video Wall Controller. It supports playing out content across the screen, controlled by multiple Viz engines.

5.1.4 External Preview

An External Preview for a video wall can be generated by a separate Viz Engine. When one video wall is configured as a preview for another, elements that are *armed* on the main video wall are *played out* on the preview video wall. In this way, it is possible to see what the program channel looks like on a physical screen, before elements are taken to air on the main screens.

After you have created your main video wall and your preview video wall, you can set up the external preview as follows:

- In the [Profiles Tab](#), double click your *main* video wall. The [Video Wall Setup Tool](#) will open.
- In the **External Preview** field, select the name of your *preview* video wall.
- Click OK.

5.2 Video Wall Designer

Use the Video Wall Designer to create and modify video wall presets. Each channel in the designer represents a graphics channel. Create the desired layout by moving, layering and resizing the channels.

There are two ways to open the Video Wall Designer:

1. Right-click a preset in the [Shortcuts Bar](#).

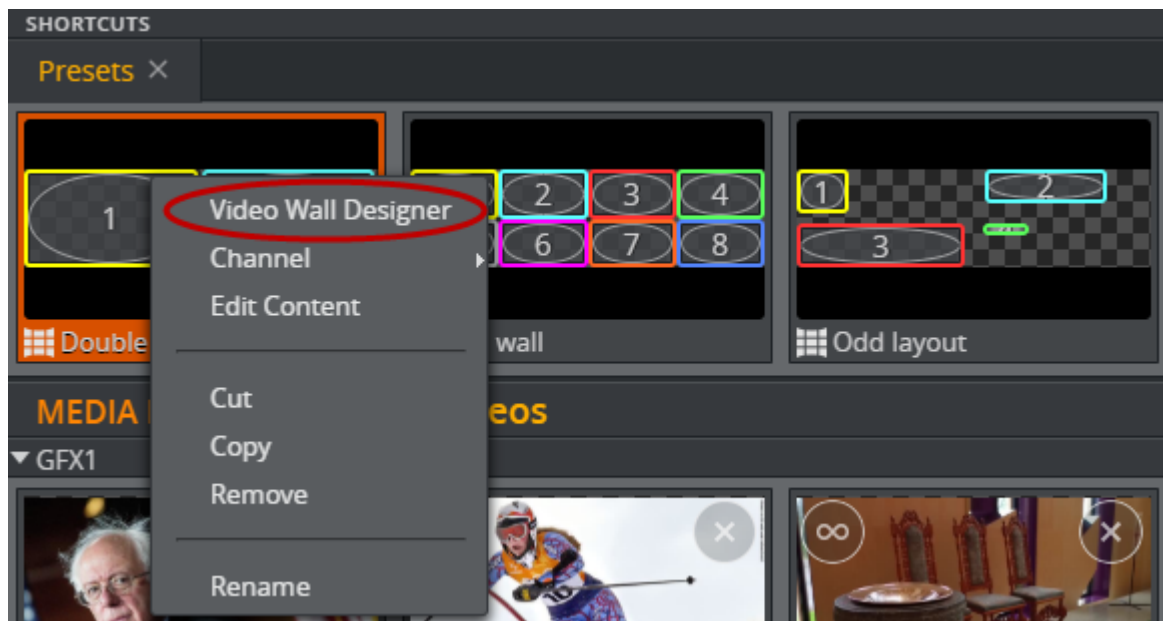

2. Right-click a preset in the Videowall Tab.

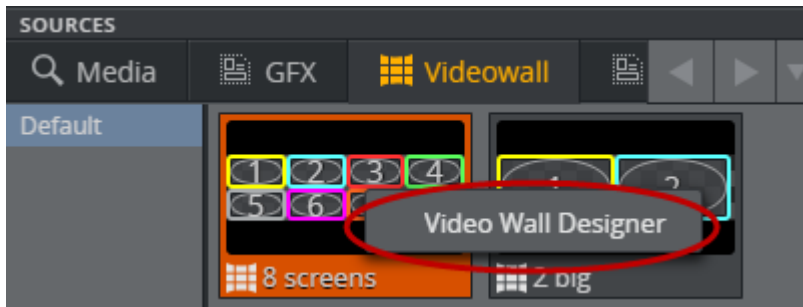

5.2.1 Areas of the Video Wall Designer

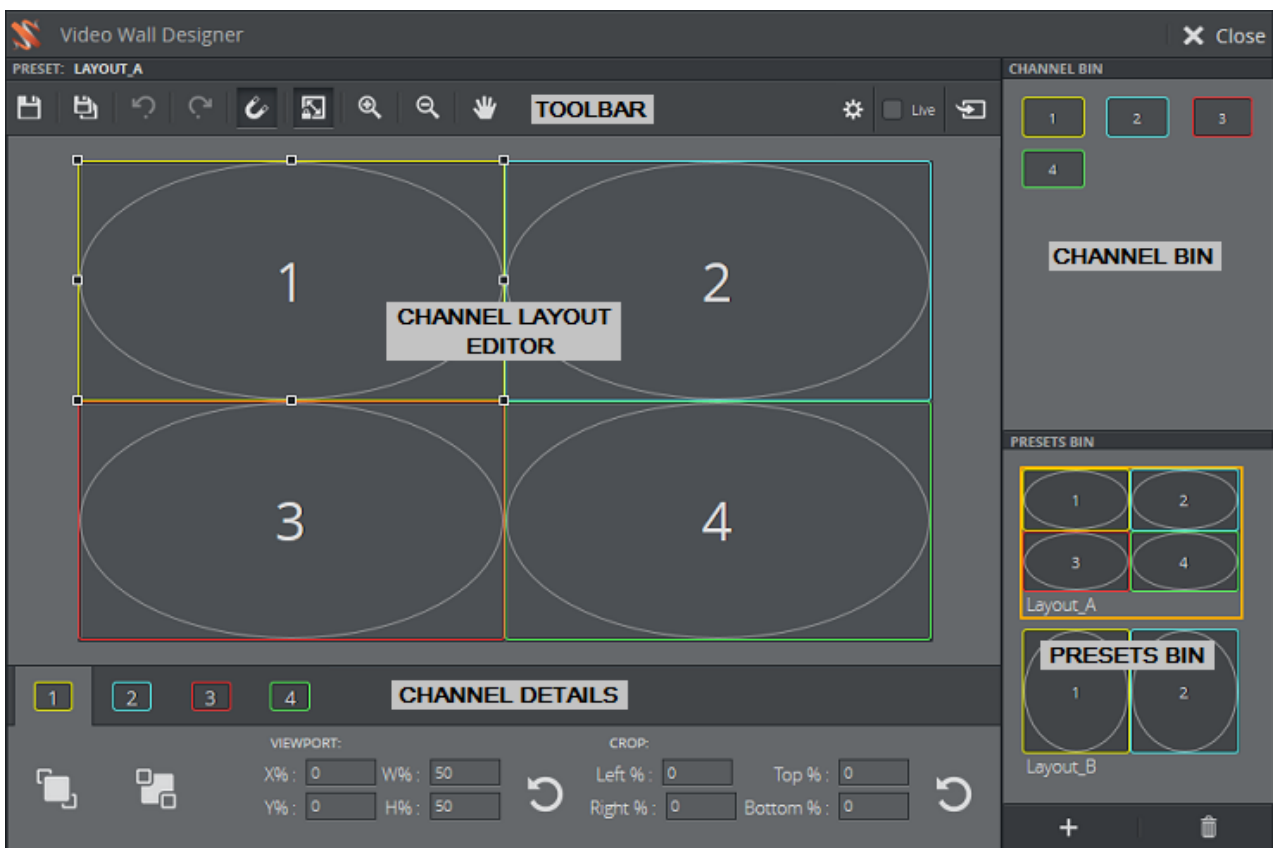

The Video Wall Designer is organized into the following areas:

- [Toolbar](#)
- [Channel Bin](#)
- [Presets Bin](#)
- [Channel Details](#)
- [Channel Layout Editor](#)

The backdrop of the Video Wall Designer layout is called

- [Active Areas Editor](#)

Toolbar



The left side of the toolbar:

- **Save:** Save changes to the current preset.
- **Save As:** Save the layout as a new preset.
- **Undo/Redo:** Undo/redo last move.
- **Toggle snapping:** Snap to a grid, to the edges of Active Areas and GFX channels.
- **Number of snap points:** The number of snap points (grid) distributed across the underlying Active Areas (the snap areas). For instance: 4 snap points will make the GFX channel snap to the edges of the underlying Active Area, and 2 in between. Increasing the snap points will make the grid finer.
- **Keep aspect ratio:** Maintains aspect ratio of the channel when the frame is cropped or resized. Also enforce the aspect given for the channel in the Profile when the GFX channel is dragged from the Channel Bin or reset.
- **Zoom in/out:** Click to zoom in or out.
- **Center.** Center the view of the video wall area. (Hint: Use the scroll wheel to zoom in and out.)
- **Pan mode:** When Pan mode is *on*, pan by dragging the background or a channel. When Pan mode is *off*, you can still drag the background to pan, but dragging a channel moves the channel. Dragging a handle always moves the handle.

The right side of the toolbar:

- **Active Areas editor mode:** Hides the GFX channels and makes the underlying Active Areas become editable. The Active Areas represents the physical dimensions of the screens in the video wall. The Active Areas are snap points to which the GFX channels will snap. See [Active Areas Editor](#).
- **Import Datapath configuration:** When the setup of the display controller hardware is done, the layout of the screens can be imported from the PC hosting the Datapath device. Only enabled in Active Areas editor mode.
- Open [Advanced Settings](#).
- **Live:** When *Live* is checked, all changes done to the preset and Active Areas are taken on air immediately. This is useful while adjusting and testing video wall configurations.
- **Color Active Areas:** When adjusting the Active Areas and being in *Live mode*, the purpose is to create a backdrop in the Video Wall Designer that matches the physical screens. When adjusting this backdrop (the Active Areas) it is useful to fill the area with a color. When clicked - the selected Active Area will be drawn with a color on the renderer, so the area can be adjusted to whether it matches the physical screen. Only enabled in Active Areas editor mode. If not clicked - and being in *Live mode* the Active Areas will be filled with whatever content that is already played in the corresponding GFX channels.

- **Take Presets:** When the *Take* button is clicked, the current state of the preset, including any unsaved changes, is taken on air. This is useful while adjusting and testing video wall configurations.
- **i:** Opens the keyboard shortcuts window.

5.2.2 Channel Bin

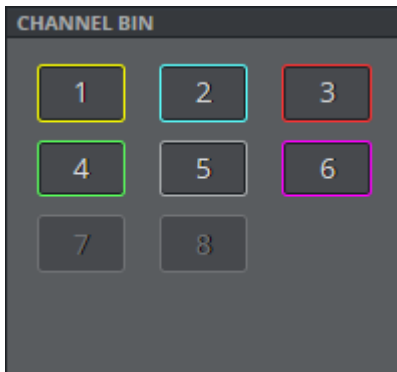

Click an item in the Channel Bin to turn it on or off in the [Channel Layout Editor](#). You can also drag channels from the Channel Bin to the video wall.

5.2.3 Presets Bin



The Presets Bin lists the presets which are available. These presets are available in the shortcuts bar with their saved names.

In the Presets Bin you can:

- **Add** or **delete** presets
- Double click on the preset to **open** it in the editor
- Double-click the name to **rename** it

Note:
If the preset or element is shown in a playlist in Viz Trio, the name given in Viz Multiplay will be shown in the *Description* column in Viz Trio.

Note:
Presets can also be deleted from within Viz Trio.

5.2.4 Channel Details

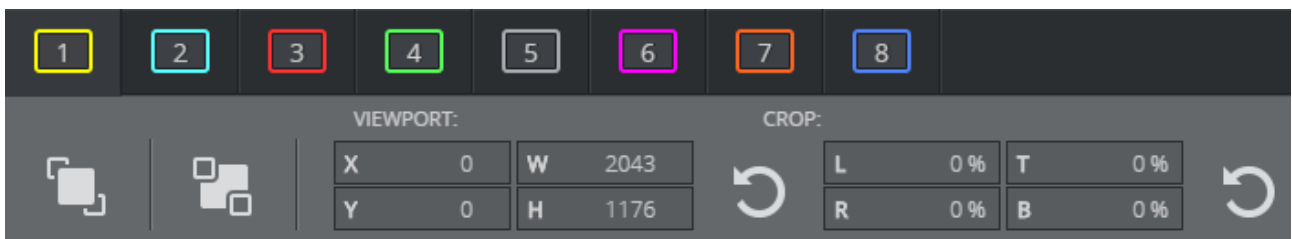

For each channel, you can modify the [Layer Order](#), [Viewport](#) and [Crop](#).

Layer Order

- **Bring to front / Send to back:** Move the selected channel to the front or back. This changes the order in which items are layered, from front to back. Each channel is drawn on its own layer, which means all channels are independent and can be moved on top of, or behind, other channels.

A dashed line indicates that a part of the channel is behind another channel.



Viewport

Position of the channel frame relative to the video wall. Either type inside the text boxes, or drag your mouse to change the values.

- **X/Y:** Position of channel's top-left corner given in the wall coordinates specified in the Video Wall Dialog. These coordinates can be pixels.
- **W/H:** Width/height of the channel's frame given in the wall coordinates specified in the Video Wall Dialog. These coordinates can be pixels.
- **Reset:** Resets the Viewport values to relocate the channel to the first Active Area of the video wall.

- ✔ **Tip:**
 When a GFX channel should not be visible - do not hide them by making them invisible. Instead, shrink the size to 0 (zero) and/or place them outside the visible video wall. The Viz Engine performance can be better when all channels are visible. All channels should be colored in the Channel Bin.

Crop

Position of the content of the channel relative to the content size. With this control you can perform cropping, shifting and zooming. Any part of the frame which is not filled with content will be transparent. Alternatively, use the [Crop Editor](#) to make these changes.

The **Crop values** in the channel tabs control the cropping. Either type inside the text boxes, or drag your mouse to change the values.

- **Left %/Right %:** Position of channel content's left/right border, relative to the channel frame (positive values push content outside the frame, negative values bring the content inside the frame)
- **Top %/Bottom %:** Position of channel content's top/bottom border, relative to the channel frame
- **Reset:** Resets the Crop values to (0,0,0,0), so that the content fills the frame.

- ✔ **Tip:**
 Adjust the **Snapping** and **Keep aspect ratio** settings in order to achieve the precise crop you require.

Example

In this case, the user has set the crop values in order to shift the entire content to the left by 10%, and zoom in by 5%.

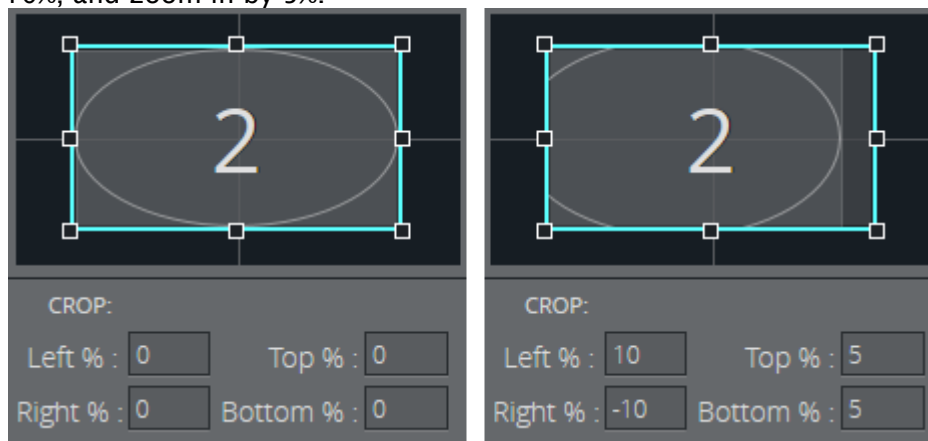

5.2.5 Channel Layout Editor

Use the Channel Layout Editor to arrange and resize the channels on your video wall.

Each channel is “drawn” on its own layer, which means all channels are independent and can be moved on top of other channels.

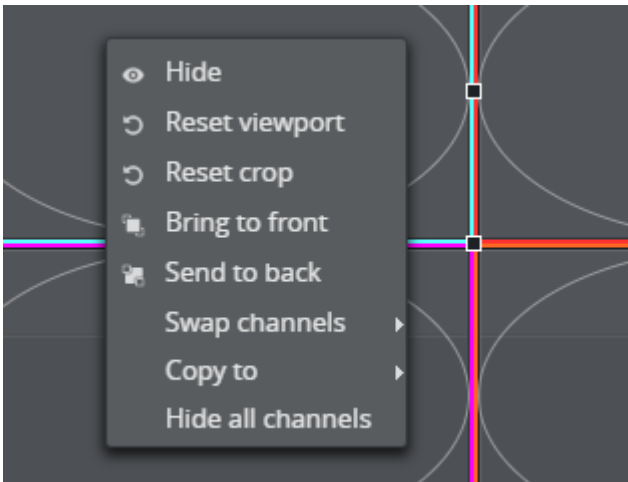

Context Menu

Right-click a channel to access the context menu:

- **Hide:** Hide this channel from the video wall. To show it again, choose it in the [Channel Bin](#), either by clicking it or dragging it from the Channel Bin onto the video wall surface.
- **Reset viewport:** Reset [Viewport](#) to the first Active Area.
- **Reset crop:** Reset [Crop](#) to (0, 0, 0, 0).
- **Bring to front:** Put this channel in front of the other channels. See [Layer Order](#).
- **Send to back:** Send this channel behind the other channels. See [Layer Order](#).
- **Swap channels:** Select another channel with which to swap all [Viewport](#) and [Crop](#) values.
- **Copy to:** Copies the size and crop values from the channel that was clicked into the channel selected on the context sub menu.
- **Hide All Channels:** Hide all GFX channels.

Crop Editor

Double-click a channel frame to allow dragging and resizing the channel content, relative to the frame. In this mode, aspect ratio is forced on. Press <Esc>, or double-click the channel, to exit this mode. Any part of the frame which is not filled with content will be transparent. Alternatively, use the [Crop](#) values in the channel tabs to make these changes.

Example

In the image below, the user has double-clicked Channel 1 to enter edit mode. They have dragged the handle (left-hand image) and then pressed Esc to see the final result (right-hand image).

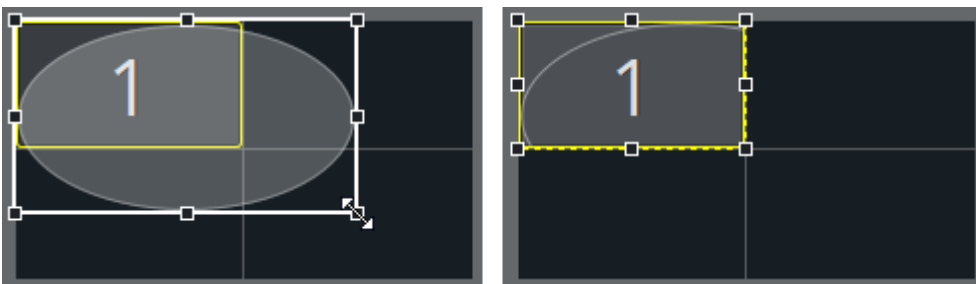

Animation between Presets

You can move channels outside the visible area of the video wall area, by dragging them or setting the [Viewport](#) values. This allows interesting in/out animations to be made when switching between presets.

Example 1

When switching from *Preset_A* to *Preset_B* (see diagrams below), channels 2, 3 and 4 will become smaller and sweep to the right, off screen, and channel 1 will stretch to fill the whole video wall.

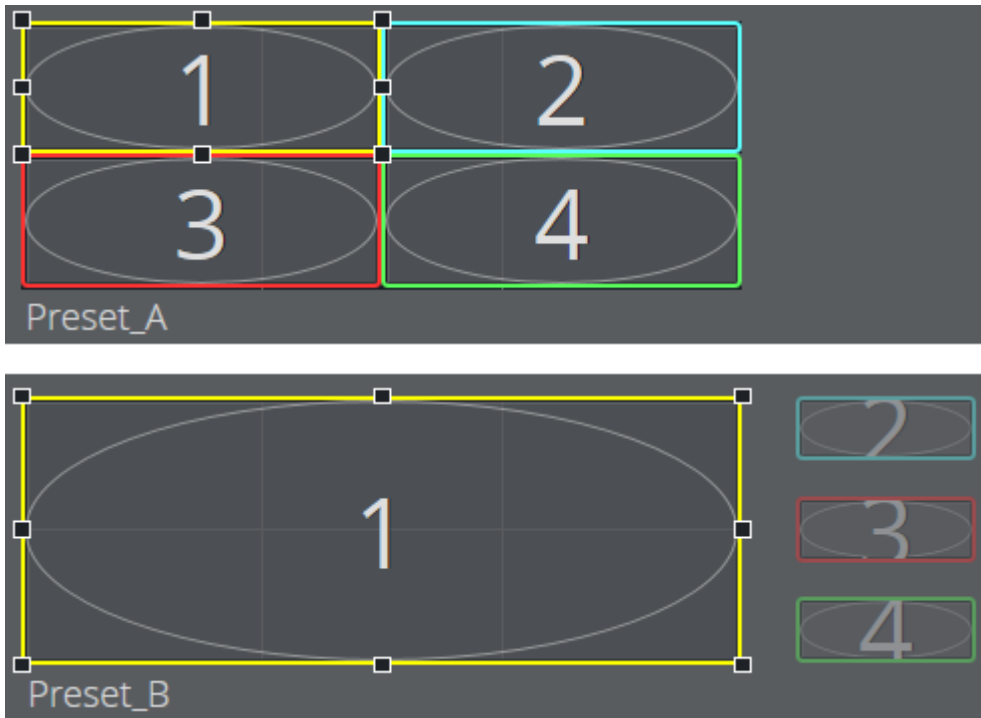

Example 2

Animate a channel so that it shrinks into nothing by using the [Viewport](#) settings to set the channel frame width and height to (0, 0).



Example 3

Control the order of the items using the layering of the channels relative to one another. Either right-click a channel frame and select Send to back/Bring to front, or select a channel frame and use the [Layer Order](#) buttons.

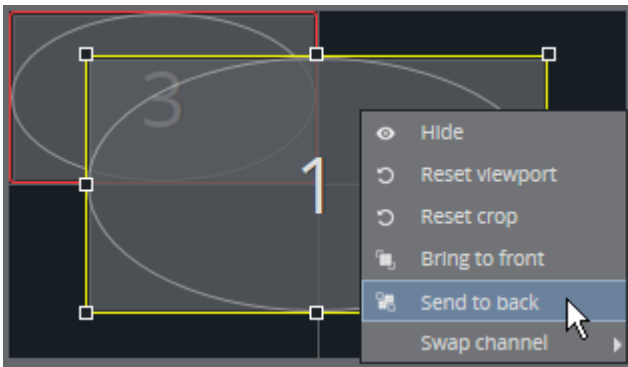

5.2.6 Active Areas Editor

In Active Areas mode, the backdrop of the video wall layout can be edited. These areas work as snap points for the GFX channels. They make it easier to create precise GFX channel layouts (presets). The backdrop represents the active areas on the video wall - for instance separate physical screens. When designing a preset, it can be useful to use the active areas to indicate where in the physical world the pixels are located. The Viz Engine draws its output on one surface - but through the use of NVidia Mosaic or the Datapath Fx4 display controller - the pixels from the renderer surface can be mapped to active areas on physical screens.

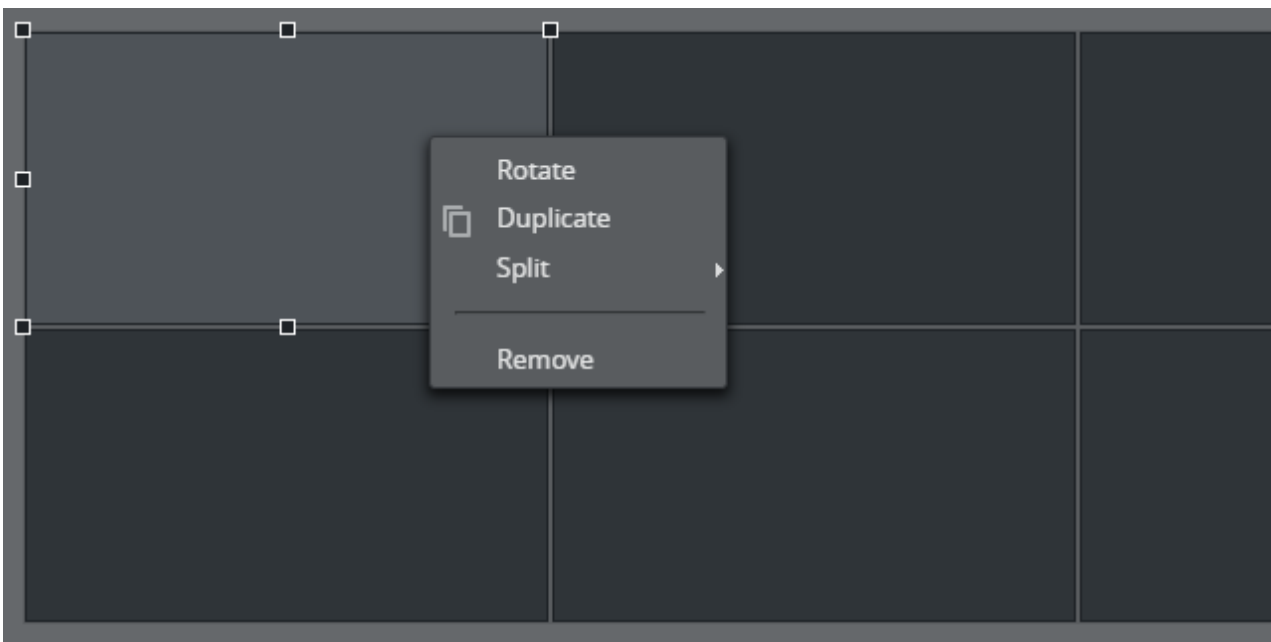

There are 3 ways the Active Areas in this editor can be created:

1. **Imported from a Datapath Fx4 configuration file.** When using one or more Datapath Fx4 devices, the wall layout from these boxes can be imported into the editor. The backdrop will then have the same layout as the configured layout in the boxes.
2. **Auto generated** based on rows, columns and screen size in the Video Wall dialog. When adding a new video wall in Profile Configuration, it is possible to specify the screen size (normally the resolution), and rows and columns of the screens. This info is used to auto generate a backdrop.

3. **Created from scratch** in the editor. Clear existing areas and start by clicking the plus button down to the right of the editor:

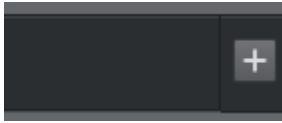

The context menu when right clicking one Active Area contains:

- **Rotate:** Rotates the active area 90 degrees. Free rotation is not supported. The content on the wall is not rotated. Only the aspect is changed.
- **Duplicate:** Duplicate the active area.
- **Split:** Split the active area into 2 or 4 new areas.
- **Remove:** Removes the active area.

✓ **Tip:**

- Use the live function to play out either the existing content of the corresponding GFX channel in the Active Areas - or a fill color. This is useful when a part of the renderer output should be mapped to a physical screen.
- Use the arrow keys to fine tune a position.

Active areas can be grouped by clicking and Ctrl + clicking areas, and right clicking on one of the areas:

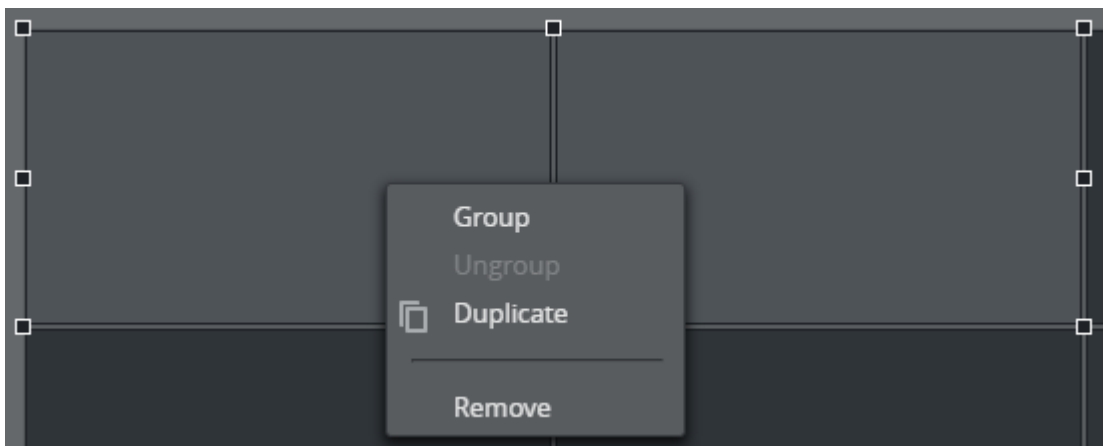

Create a group of the selected areas. The areas can be moved, resized and deleted as one unit. The group number is located at the bottom of the editor:



The highlighted numbers indicate whether a group or an individual Active Area is selected. To toggle between individual selection and group selection - click the active area. Keep an eye on the highlighted numbers and the selection markers around the active areas to see whether the selection contains a group or an Active Area.

**Tip:**

It is possible to undo and redo operations in Active Areas mode. The configuration is saved automatically.

5.3 Preset Content Editor

The Preset Content Editor is an editor for filling video wall [Presets](#) with predefined content, which are then referred to as [Filled Presets](#).

In the editor, search for content (videos, graphics, images) and drag it into a preset. Depending on your configuration, content is contained in various tabs, including the Templates, GFX and Media tabs etc. When the filled preset is ready, drag it either into the group for the main channel of the video wall, or to the shortcuts bar in the show.

5.3.1 Open the Preset Content Editor



Filled Presets can be located in the Shortcuts bar (a good idea is to create a separate group for filled presets, and keep the presets in another group) or in the main channel of a video wall. If located in the main channel, the filled presets belong to the currently selected group in the current playlist. If located on the shortcuts bar, they are always available.

1. Right-click a preset in the [Shortcuts Bar](#) or in the main channel of the video wall.

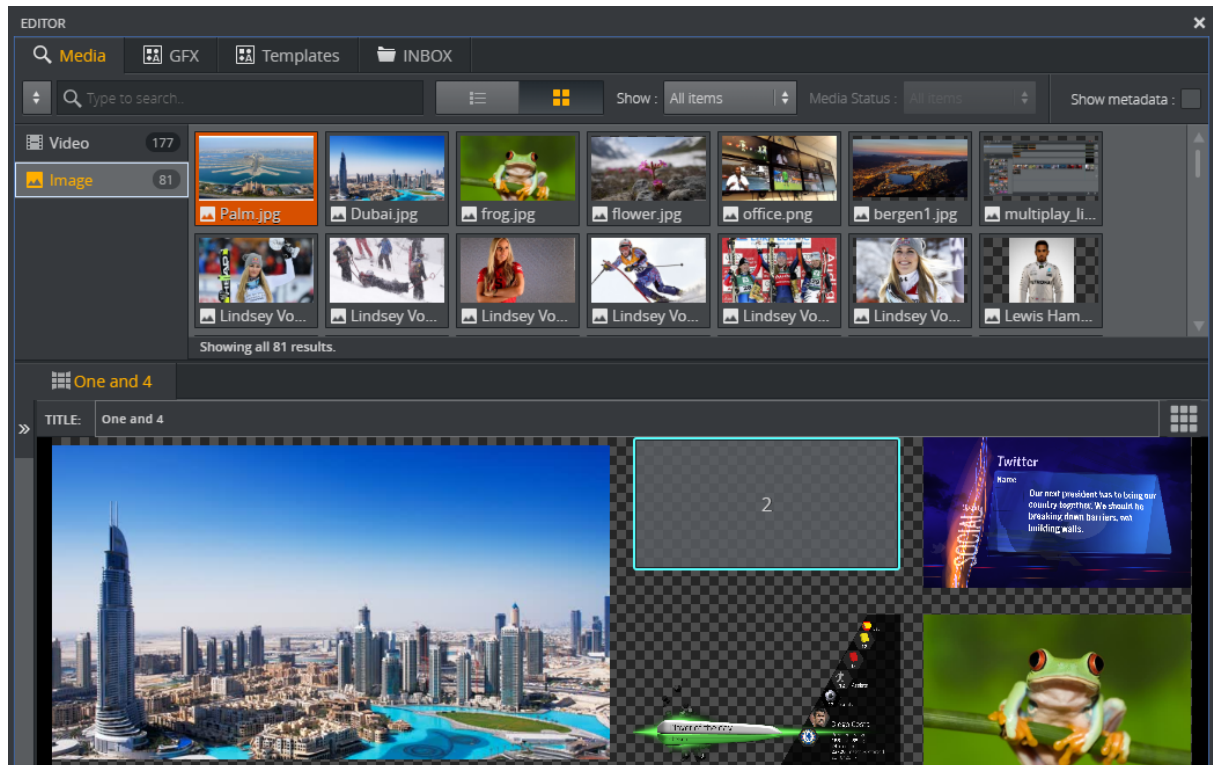
2. Click **Edit Content** to open the Preset Content Editor:



In this editor, you can create a video wall layout with content filled into the GFX areas:

- From the top tab bar, select a source for the content. This can be Media assets, graphics or content from an inbox.
- Drag selected content into the GFX areas.
- Click the Play button  on the thumbnails to edit, or alternatively double-click content or right-click and select **Edit**.
- Click the View Mode button  to switch between actual video wall layout and all GFX channels visible.

See also:

[Creating prefilled walls](#)

5.4 Advanced Settings

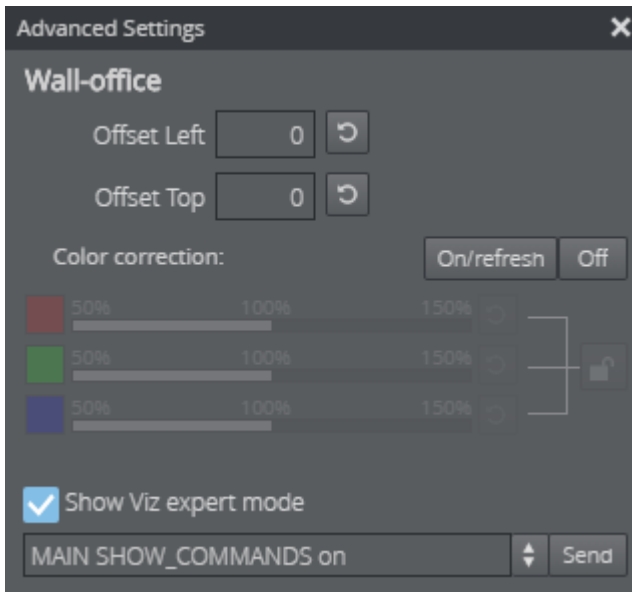

Open the Advanced Settings by clicking the  icon on the toolbar of the [Video Wall Designer](#)

5.4.1 Offset

An advanced feature in Viz Multiplay is that multiple video walls driven by separate Viz Engines can be merged into one “studio”. Each wall is controlled by one Viz Engine, and when content is played out on a GFX channel, each Viz Engine plays out the same content, but different parts of it, so the content can span over several video walls.

Each wall has a dimension and an offset in the total “studio” area.

Use the Offset Left and Offset Top values to adjust the wall positions “live”.

5.4.2 Color Correction on the GPU

Note:
Color Correction via the Studio Editor requires Viz Engine 3.8.2 or later, as well as NVIDIA Quadro 5000, 6000 or Plex 7000.

From the Studio Editor, RGB intensity can be controlled directly on the GPU for each video wall.

To use this feature, open the Studio Editor from within the Video Wall Designer, and adjust the **RGB sliders** for each of the renderers in the video wall setup.

5.4.3 Show Viz expert mode

When **Show Viz expert mode** is enabled, Viz commands can be sent directly to the Viz Engine. Select a command from the drop down, or enter your own command and click **Send**. The default commands in the drop down are:

Command	Description
MAIN SHOW_COMMANDS on	Display incoming Viz Commands and their replies on the Viz Engine console. Useful for debugging.
MAIN SHOW_COMMANDS off	Hide Viz Commands on the Viz Engine console.
RENDERER JOIN_SWAPGROUP 1	Necessary to send this command once if the Viz Engine PC has more than one GPU installed.
RENDERER SET_PERFORMANCE 1	Display the performance bar in the bottom of the Viz Engine renderer. Useful for debugging.
RENDERER SET_PERFORMANCE 0	Hide the performance bar.
SCANOUT_INTENSITY SET 1 1 1	Set the color correction values manually. The arguments are R, G, B, between 0.5 and 1.5. 1 is normal intensity.
SCANOUT_INTENSITY RESET	Disable color correction on the GPU.

6 Workflows

This Chapter provides an overview of Viz Multiplay and its supported workflows.

It outlines setting up and configuring video walls and video wall layouts. It provides instruction on preparing, organizing and editing content, in addition to previewing and playing out videos, clips and graphics.



Note:

The physical video wall hardware is outside the scope of this chapter.

This chapter contains the following sections:

- [Glossary of terms](#)
- [Setup and organize content](#)
- [Setup and configure single and multiple video walls](#)
- [Screens with different sizes and resolutions](#)
- [Presets](#)
- [Creating prefilled walls](#)
- [Working with Viz Pilot and MOS content](#)

6.1 Glossary Of Terms

The following is a list of the terms and their definitions found in this chapter:

- **Show:** A Viz Trio compatible data structure on the Media Sequencer that describes a set of elements (graphics, videos, images) and playlists.
- **Profile:** A defined set of layout channels and video walls. A profile
- **Channel:** One or more Viz Engine connections. Typically either a Viz output, a video output, or both.
- **Video wall:** A unit describing the physical layout of a set of screens. Each video wall belongs to one profile. The layout (rows, columns, screen dimensions, bezels) must match the NVIDIA Mosaic setup.
- **Main channel:** The Viz output on which the video wall presets are run. This is normally host: 6100. On this channel, only presets and backgrounds should be taken.
- **GFX channels:** Each video wall has one main channel and up to 16 GFX channels. The GFX channels can freely move and resize within the video wall. The GFX channels can host images, videos or Viz Artist scenes.
- **Preset:** The layout of a video wall, describing the placement of the GFX channels. The presets are scenes played out on the video wall main channel.
- **Workspace:** A set of constraints that enable customizing the GUI per client. For example, hide channels that are uninteresting for a specific user, i.e. an anchor in the studio.
- **Arm:** When 1-tap mode is off, elements are sent to the arm column, indicating that the element is ready to be played out.

6.2 Setup And Organize Content

This section covers how to import graphics and set up servers to fill Viz Multiplay with content ready to be played out on the video wall.

The following topics are covered in this section:

- [Setting up a preview server](#)
- [Getting started with shows and profiles](#)
- [Shortcuts](#)
- [Working with graphics](#)
- [Inboxes](#)
- [Working with images and videos](#)
- [Edit graphics, videos and images](#)

6.2.1 Setting up a preview server

Viz Multiplay's GUI largely consists of thumbnails for the elements, including video clips, images and graphics.

The thumbnails for video clips and images are fetched by following URLs to thumbnail images served out by the asset management system. But the thumbnails for graphics are generated on the fly by a Preview Server, which ensures that the thumbnails contain the actual data of the elements:

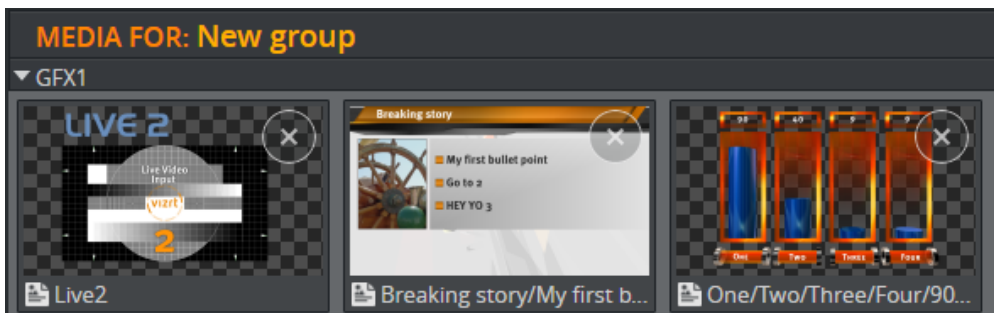

Without a Preview Server configured, the thumbnails of graphics will remain blacked out.



Tip:

Viz Multiplay uses the Preview Server configuration in the Media Sequencer. So if you use a Media Sequencer with a Preview Server already configured, there is no need to do anything in Viz Multiplay.

Running Preview Server

To run a Preview Server, you need a separate Viz Engine in VGA mode. A Viz Engine generating snapshots for a Preview Server cannot be combined with other tasks like running Viz Trio or Viz Artist.

1. When a Preview Server is up and running, click **Settings** -> **Servers**

2. Enter the hostname of the Preview Server in the input field:

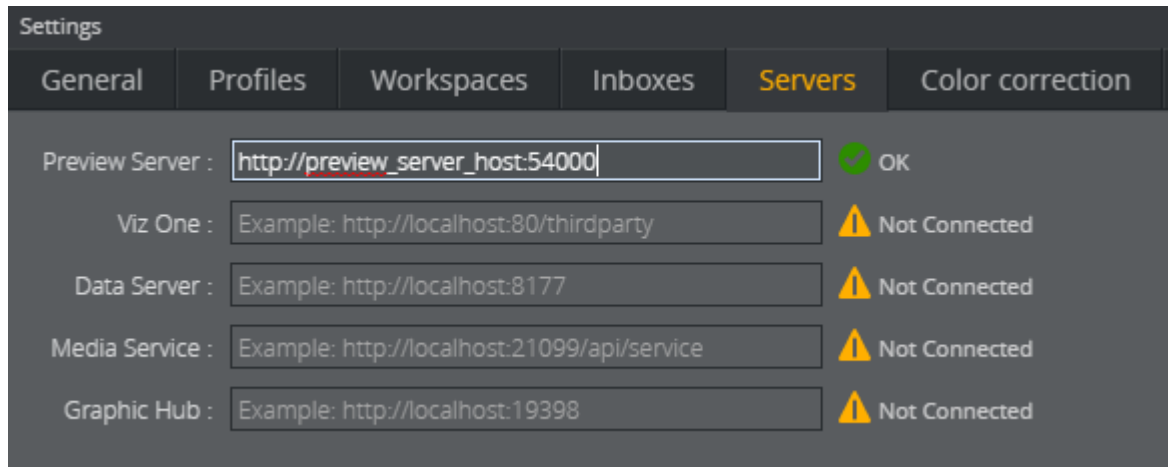

3. Press the **TAB** key, Viz Multiplay will fill out the rest of the URL
4. Click **Ok**
5. The thumbnails should now appear in the GUI if you have graphics in your show or playlist

✓ **Tip:**
The Viz Engine will generate snapshots requested by the Preview Server. This is normally done very quickly. However, it can take a few seconds before the thumbnails appear if your show or playlist contains a large number of elements. After that they should be cached in the Preview Server or in the web browser, so the GUI will redraw quicker.

✓ **Tip:**
Remember that the Preview Server is connected to one or more Viz Engines. These engines are connected to one Graphic Hub database with the scenes and resources. When you later import graphics from different sources (e.g. Viz Trio, Pilot Data Server) the scenes used in these graphics must exist on the Graphic Hub used in the Preview Server. Preferably, you will only have one Graphic Hub on the system containing all your graphics.

See Also

- Preview Server Administrator Guide 3.0.

6.2.2 Getting started with shows and profiles

In a playout situation, Viz Multiplay is an independent client. When preparing and configuring material for playout, Viz Trio is needed to:

- Import graphics from a Viz Engine
- Configure a Viz Gateway (a MOS/newsroom workflow)

Content in Viz Multiplay is based on the Viz Trio show structure. Any show you create in Viz Trio is usable in Viz Multiplay and vice versa. However, there is one important difference: In Viz Multiplay the content is organized in groups. The workflow in Viz Multiplay is to select a

group and control the content in the selected group. Therefore, elements on the root level in the show or playlists are not accessible in Viz Multiplay.

Creating shows and profiles involves the following steps:

- Create a new show
- Create a profile
- Create playout channels in the profile
- View output channels

Create a new show

The first step is to create a new show.

1. Click the **Open** button:

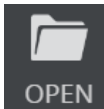

2. Click the **Add (+)** button in the bottom of the dialog box
3. Give the new show a name
4. Click **Ok**

Note:
The show structure in Viz Multiplay is compatible with a Viz Trio show.

The [Show Pane](#) will now have one tab with the same name as the show, as shown here:

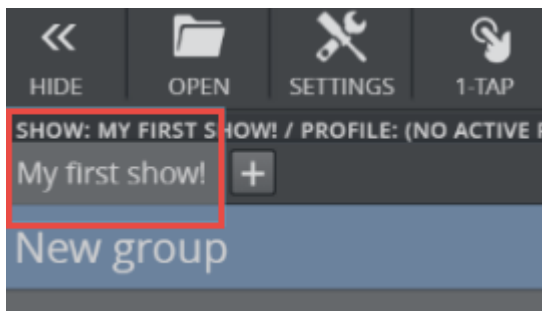

This tab displays the content of the page list in the Viz Trio show.

Differences between Viz Trio and Viz Multiplay

Shows and page lists appear in both Viz Trio and Viz Multiplay, but they behave differently in each program.

In terms of the page list, the difference between Viz Multiplay and Viz Trio is that, in Viz Trio, the page list is mostly used to host pages with unique callup codes. In Viz Multiplay, however, the page list is a free structure that can contain any type of element with any name.

Another difference between a show in Viz Trio and Viz Multiplay is that Viz Trio displays the playlist of elements as a tree structure while Viz Multiplay organizes the playlist per channel. So all elements in a group assigned to, for instance, the channel GFX2 are placed in the row representing

GFX2 in the GUI. This is why you must create and activate a profile for your show in Viz Multiplay, because the profile contains the channels Viz Multiplay needs in order to organize the elements.

Create a profile

You need a profile so Viz Multiplay can create one row for each channel in the GUI. The profiles you create in Viz Multiplay are compatible with any Media Sequencer client that uses profiles such as Viz Pilot, Viz Trio etc.

1. Click **Settings > Profiles**:

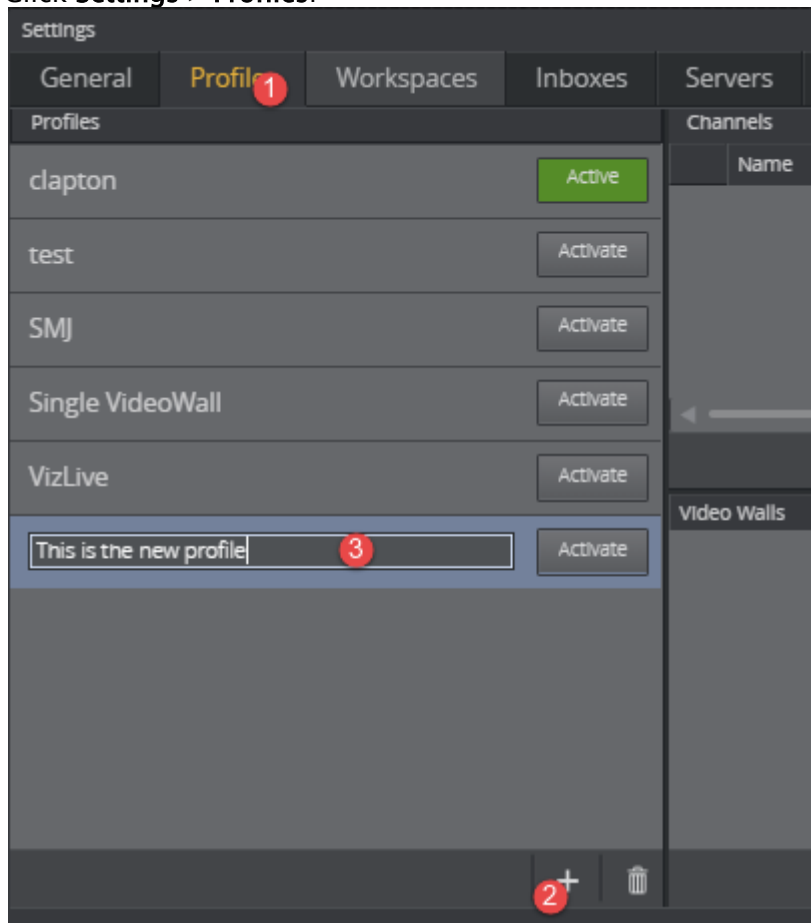

2. Create a new profile by clicking the **Add (+)** button at the bottom of the Profiles list
3. Enter the name of the new profile

Create playout channels in the profile

There are two ways to create playout channels in the profile:

1. **Create channels manually (usually for a non video wall scenario).** In this case, you must add Viz Engines and Video Engines in the window to the right in the Profile Configuration. Then create channels in the middle window and drag engines over to the channels. One channel can contain several engines.
2. **Create a video wall.** The channels and engines will be automatically created. For now, you can, for instance, create a video wall with 4 GFX channels on localhost.

To create playout channels in the profile

1. Click **Settings > Profiles**.
2. Click the **Add (+)** button in the **Video Walls** list

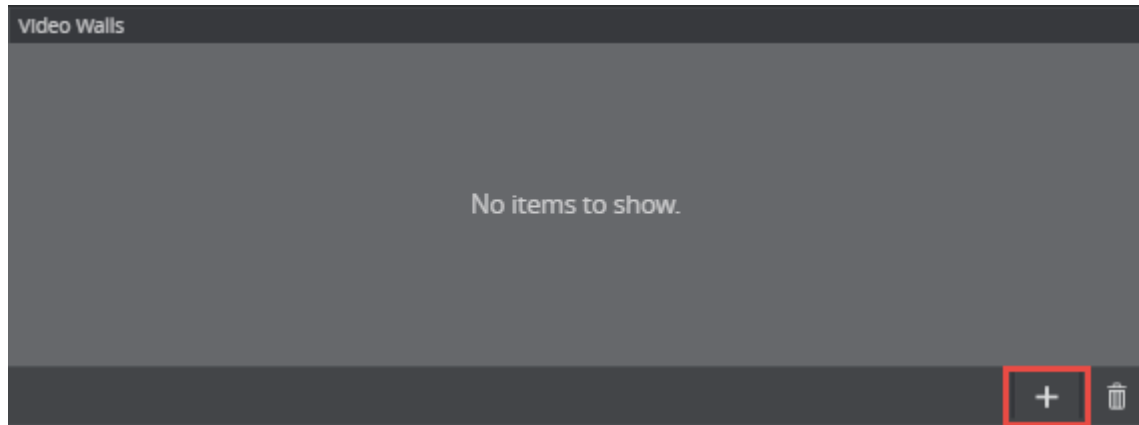

3. Fill in some dummy data in the **New Video Wall Setup** dialog

4. Click **Ok**

New Video Wall Setup

Name : My first video wall

Merge Into : (None)

Host or IP : localhost

Asset Storage : (No Storage)

First GFX Port : 55000

GFX Channels : 4

Main Channel : A

Channel Prefix : GFX

Screen Rows : 2

Screen Columns : 2

Wall Offset Left : 0

Wall Offset Top : 0

Bezel Width : 0

Bezel Height : 0

Screen Width : 1600

Screen Height : 900

External Preview : (None)

Ok Cancel

- ✓ **Tip:** The channels list in a profile can be reorganized by clicking a channel, holding down **CTRL** and using the **ARROW KEYS** to move the channel up or down. This is useful if you want to, for instance, display GFX8 on the top of the GUI in Viz Multiplay. Viz Multiplay draws the channel groups in the order channels are found in the profile.

Now you have a profile and a show with a page list containing one group called **New group**:

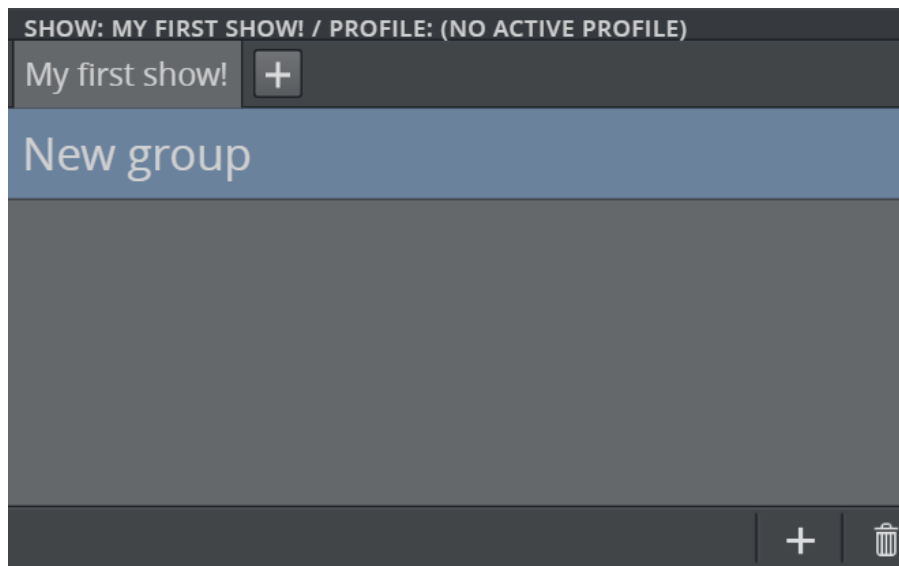

View output channels

You must activate the profile for this show in order to view the output channels in the GUI.

1. Go to **Settings > Profiles**
2. Click the **Activate** button for your profile

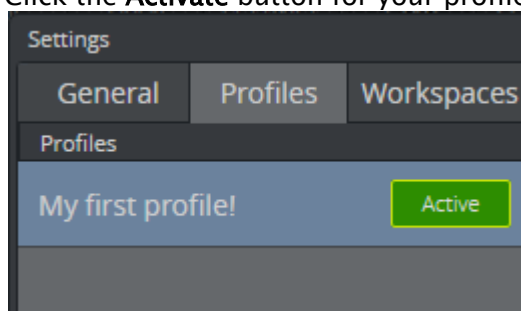

✓ **Tip:** Activating a profile is a Media Sequencer operation. You now activate your show in this profile for all clients with this show open. Activating a show in a profile means that the Media Sequencer starts monitoring resources in that show, so the operation is potentially resource demanding in the event of a large show that contains lots of media assets. Your show can only be active in one profile.

6.2.3 Shortcuts

When you created the new show, Viz Multiplay created and set up a special playlist in this show called **shortcuts**. The shortcuts playlist is a regular playlist with groups and elements.

If desired, you can use another playlist as the shortcuts playlist by clicking **Settings > General**. In the Shortcuts dropdown, you can select any available playlist and use it as the shortcuts playlist.

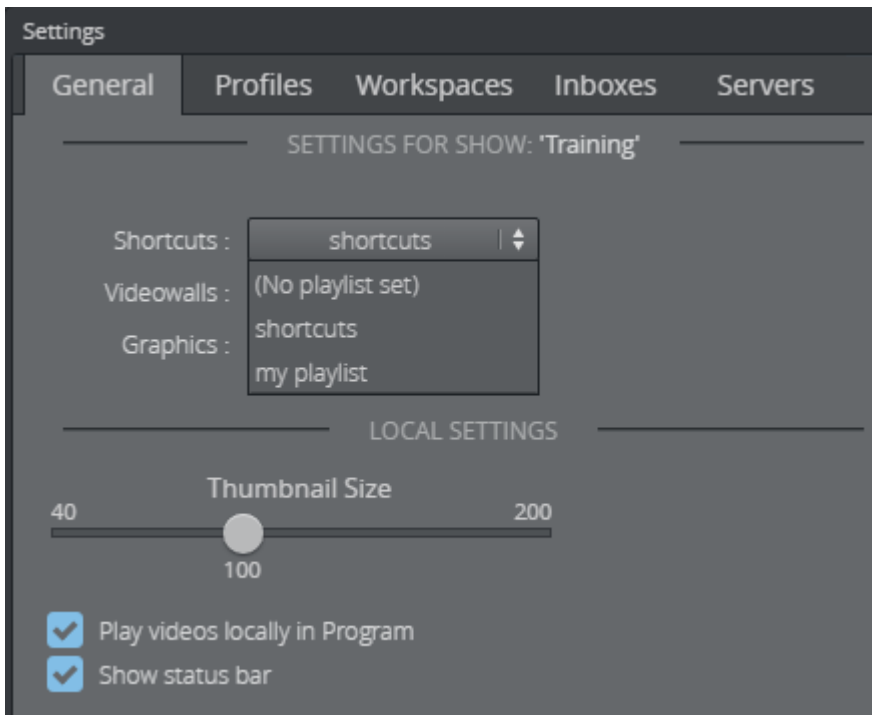

The shortcuts playlist will appear in the [Shortcuts Bar](#). Each tab here is a group in the playlist. Create a new group in Viz Trio or click **Settings > General** and de-assign it as the shortcuts playlist. Select **(No playlist set)** as the value in the Shortcuts dropdown. Now it becomes a regular playlist in Viz Multiplay, where you can add or remove groups.

The Shortcuts bar is not assigned to any special channel, as the other channel groups in Viz Multiplay are. Elements in the shortcuts bar play out on the assigned channel of each element. This means that if you drag an element from the GFX playlist directly to the Shortcuts bar, the element will keep its assigned channel. If the element has no assigned channel, it will play out on the Program channel in the profile.

- ✔ **Tip:**
 The Shortcuts bar normally contains the video wall presets, “filled” video walls (presets with content) and backgrounds. These should be played out on the main channel of the video wall using the defaults from Viz Multiplay. The main channel is called **A**. Right-click elements on the Shortcuts bar to check and change the playout channel.

6.2.4 Working with graphics

Now we want to import some graphics from a Graphic Hub.

Basic scene import

For basic scene import, without support for Transition Logic - use the Import scene function directly in Viz Multiplay to import graphics created in Viz Artist. Right-click anywhere and select **Import graphics**:

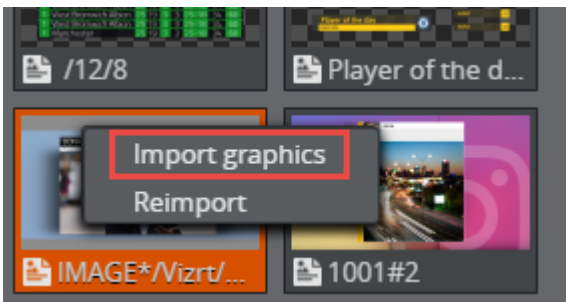

See [Importing graphics](#).

Using Viz Trio

Graphics can be imported into Viz Multiplay by using Viz Trio. This is handy if you need to import Transition Logic scenes or already have a graphics system running with Viz Trio. In Viz Trio:

1. Select **Import Scenes** in the Page Editor menu

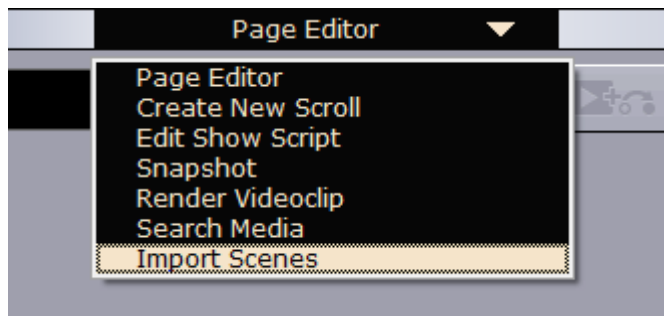

2. Browse the scene tree in Graphic Hub and import the scenes you want to use

Note:
You now have one template per scene you imported. These are not visible in Viz Multiplay.

3. Create a page for each of the templates

Note:
These pages end up on the root level of the page list in Viz Trio, not visible in Viz Multiplay.

The show workflow and the GFX workflow are the two main ways of working with graphics in Viz Multiplay

The show workflow

This workflow aims to pre-create all the content needed for the Viz Multiplay operator, before the actual show or broadcast starts. This is meaningful if you already have a Viz Trio workflow, or if you have content that changes very little during the broadcast.

In Viz Trio:

1. Create all your content in Viz Trio as pages
2. Drag the pages into the relevant groups in your show.
3. Set a channel on each of the pages to make them appear in the right group channel in Viz Multiplay.

In Viz Multiplay:

1. Drag elements between channels

The GFX playlist workflow

As your studio increasingly becomes the location for event analysis, you can get more video wall flexibility by allowing the Viz Multiplay operator to fill in content for graphics.

For basic scenes, you can [import graphics](#) directly into Viz Multiplay from the Viz Multiplay GUI, or use Viz Trio to create default content (i.e. pages) for the graphics you want to expose to the Viz Multiplay operator. These pages can be dragged down to relevant groups in the GFX playlist in Viz Trio.

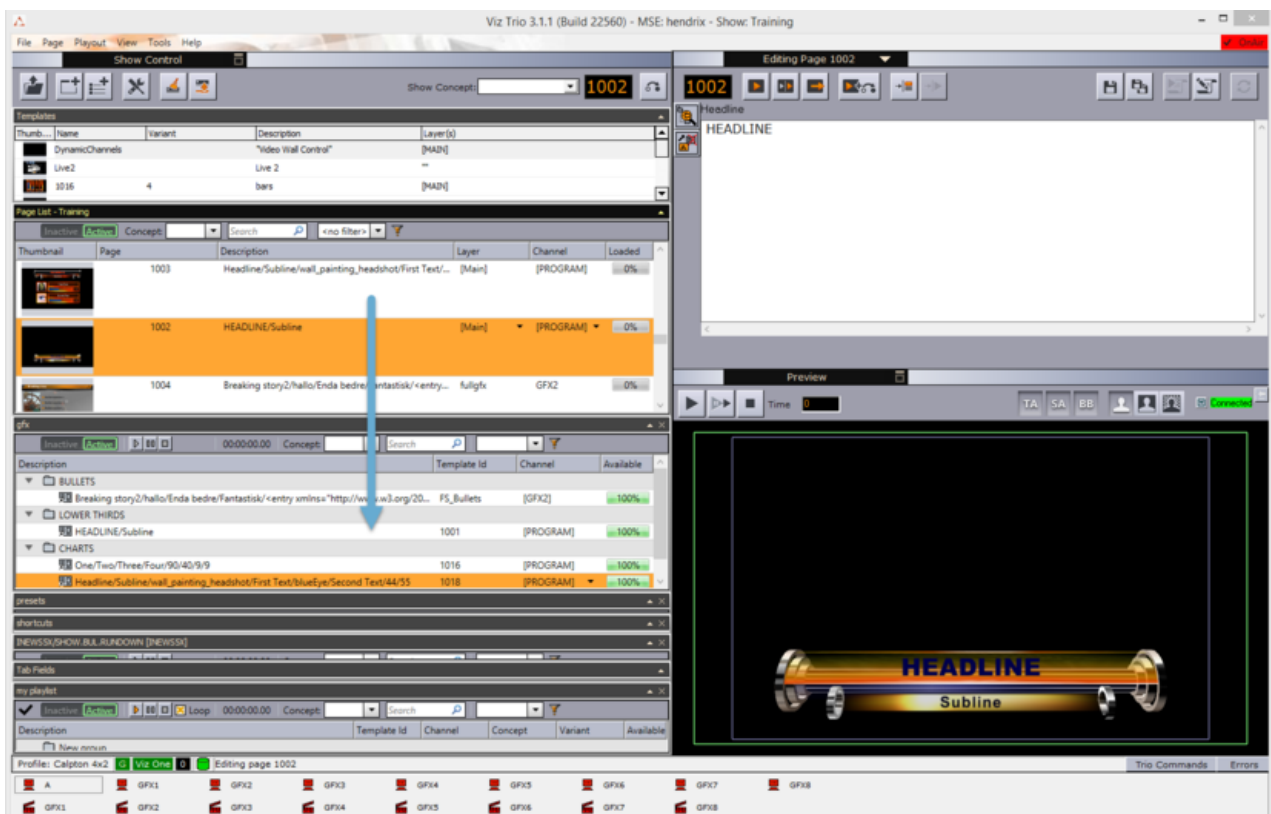

The GFX playlist will appear as a tab in the [Sources Pane](#). After completing this Viz Trio is no longer needed. From the GFX playlist, the Viz Multiplay operator can drag graphics into the relevant groups and channels, quickly edit the data in Viz Multiplay and take the element on air.

Note:
Graphics elements can also be dragged from a channel into the GFX playlist.

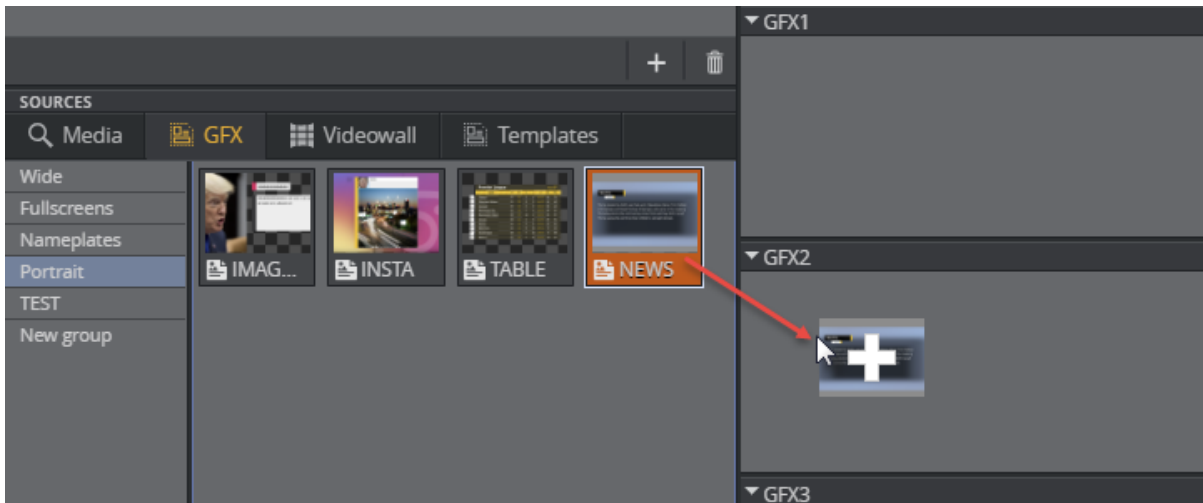

This workflow is a more rapid, 'live' workflow where you can, for example, place a set of graphics in the GFX playlist (nameplates, match results, fullscreens etc.) During the broadcast or event, the Viz Multiplay operator can drag the set of graphics out to the playout channel, fill the graphics with relevant data and take it on air instantly.

Create playlists for shows

A show can also have playlists, as in Viz Trio. You can create new playlists inside the show with Viz Trio or Viz Multiplay. A playlist is usually a subset of the pages in the page list.

In Viz Multiplay:

1. Click the **Add (+)** button rightmost on the tabs in the Show pane

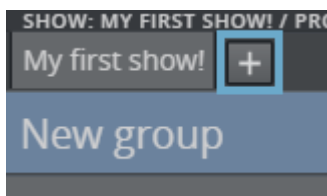

2. A dialog box appears asking whether you want to create a new internal show playlist or create a reference to an external Viz Pilot or MOS playlist. These playlists are compatible

with Viz Multiplay.

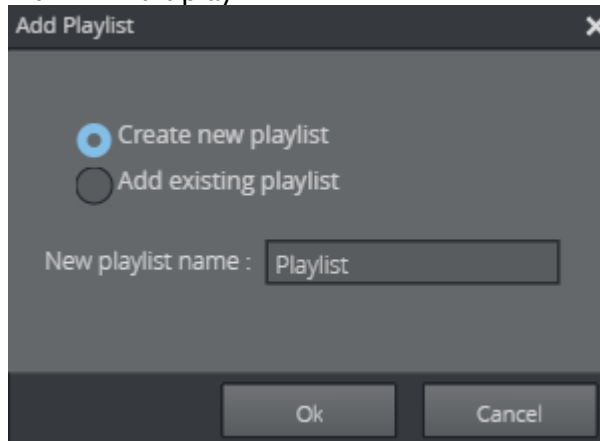

⚠ Note:

These playlists are compatible with Viz Multiplay. The difference between internal and external playlists is that the internal playlists are owned by the show. They follow the show when exporting it and are deleted when removed from the show. The external playlists are not owned by the show.

6.2.5 Inboxes

The inboxes are global shows that are always available in the Sources pane. They can contain any type of element (images, clips and graphics), and the content does not have to be placed in groups.

Typical use of inboxes are:

- For a special show that is a target for Sequencer Ingest. New ingested material will then appear automatically in the inbox, ready to be used in Viz Multiplay.
- For listing available live source elements. These can be dragged to any group channel in Viz Multiplay and played out.
- For graphics created during the broadcast or event that are imported by a Viz Trio operator into the inbox show. Then the graphics is available instantly in Viz Multiplay.

To use a show as an inbox:

1. Click **Settings > Inboxes**
2. Create a new show or select an existing show
3. Drag the show over to the Inboxes list to the right

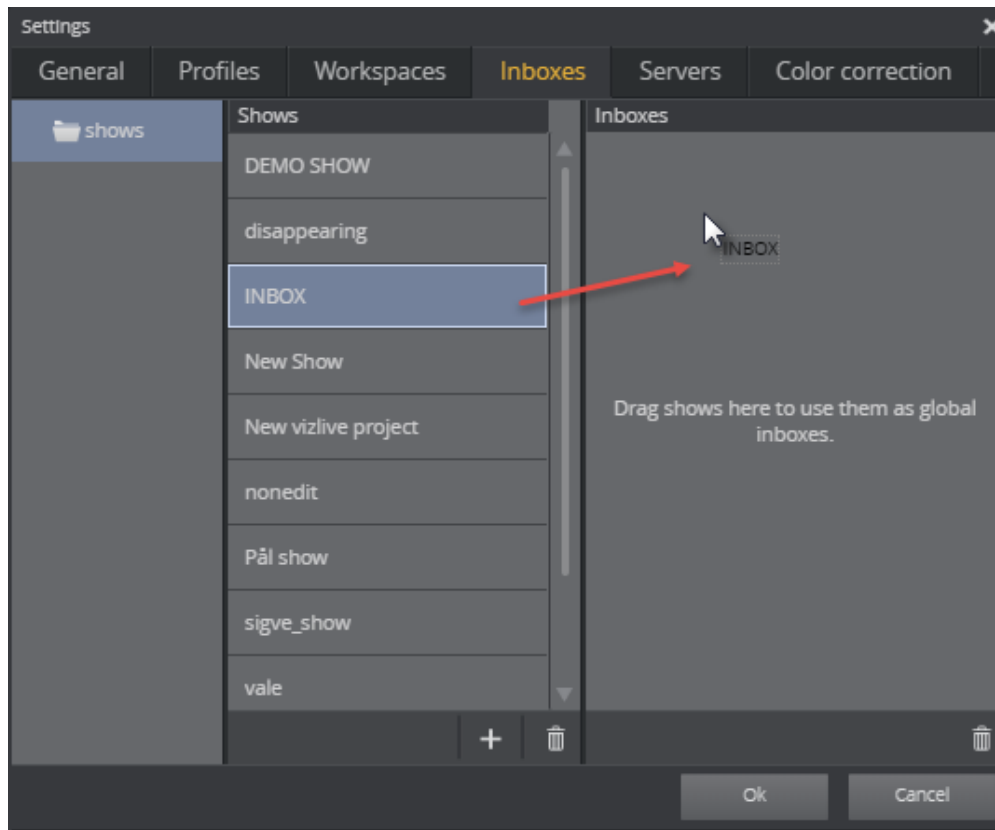

4. The show will now appear in the Sources pane:

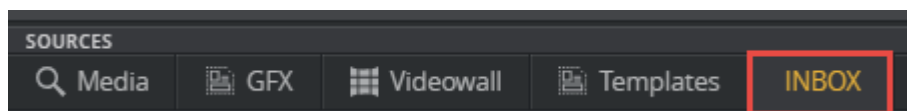

6.2.6 Working with images and videos

To get media assets into Viz Multiplay, you need to have access to a MAM system such as Media Service, Viz One or a Graphic Hub REST service (images only).

When a MAM system is up and running:

1. Go to **Settings > Servers**
2. Enter a hostname in the input field for the service
3. Press TAB, and Viz Multiplay will fill out the full URL
4. After clicking **Ok**, the **Media Tab** in the Sources pane will contain your MAM system as a search provider.

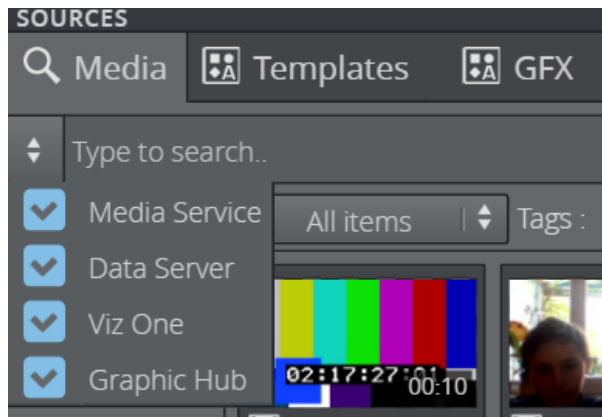

Setting asset storage

The Viz One setting is global for the Media Sequencer. Configuring this means that the Media Sequencer starts to monitor shows and playlists and transfers assets to the Viz Engines. In case you have a Viz One system, you also need to set the Asset Storage in the video wall dialog box.

Do so by clicking **Settings > Profiles** and double-clicking the video wall in the selected profile.



Note:

If you do not have video walls, the Asset Storage must be set for each Viz and or Video Engine in the list to the right. Failure to do so will result in videos not being transferred to the Viz Engine.

Configuring the Media Service

There are two ways to configure the Media Service, as explained below.

By entering the hostname in Media Service

1. Click **Settings > Servers**
2. Enter the Media Service URL (or hostname) in the Media Service input field
This setting is private for Viz Multiplay; the Media Sequencer is not aware of it. The Media Sequencer will think that no asset storage is configured. This works fine, because a Media Service is meant to host its clips on the clip root of the Viz Engine, so they do not need to be transferred. But it can lead to some error messages from the MSE and in Viz Trio - so there is another way of configuring Media Service.

By entering the hostname in Viz One input field

1. Click **Settings > Servers**
2. Enter the Media Service URL (not only the hostname) in the Viz One input field.
The Media Sequencer now thinks it communicates with a Viz One service - and Media Service uses the same API as Viz One, although no file transfers are needed. Use this method if it is OK that the Media Sequencer is configured with a Media Service. Remember that this configuration is common for all users of the Media Sequencer.

If you use a Media Service, all the Viz Engines must use the Media Service clip folder as their clip root, i.e. a shared disk. This can affect playout performance. If you have a single Viz Engine, a Media Service is well suited to run on the same PC as the Viz Engine, and they both have access to the local clip root folder.

If you have set up a **Graphic Hub REST service** you have access to images in the Graphic Hub. These images will have best performance when playing them out because they can be pre-loaded. Images from Viz One and the Media Service are loaded when they are played out, and that can produce a small delay.

You can configure all search providers and only search in some of them by checking or unchecking the boxes in the search provider's list in the search panel.

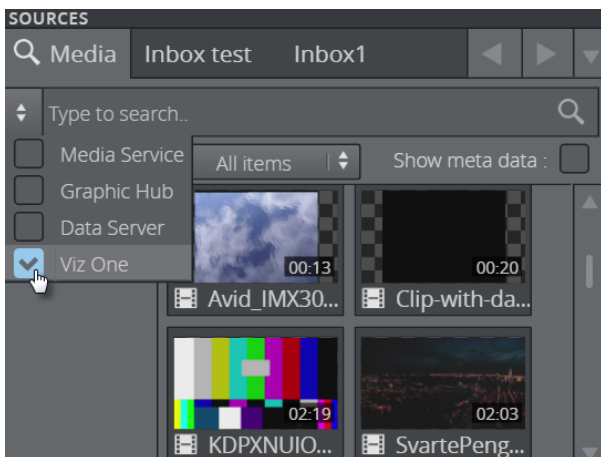

6.2.7 Edit graphics, videos and images

Viz Multiplay is not just a playout client. If a show is carefully prepared and an asset provider is set up, the Viz Multiplay operator can also add and edit elements during the broadcast or event. This provides for more flexibility in the studio.

This sub-section covers the following topics:

- Example workflow
- Editing elements
- Setting in and out points in video clips
- Zooming and cropping images
- Editing graphics

Example workflow

In Viz Trio:

1. Prepare a show by importing scenes from a Graphics Hub into a show. These scenes become templates in the show.
2. Create pages of the most used graphics and drag them to groups in the GFX playlist.
3. Now, these pages are available for the Viz Multiplay operator.

In Viz Multiplay:

1. During the broadcast or event, the Viz Multiplay operator selects the page list or a playlist in the [Show Pane](#).

2. Click a group. Now each group channel is populated with the relevant elements.
3. The Viz Multiplay operator sees that he needs a new element (a video, an image or graphics). He finds it in a source (the Media tab, an inbox, the GFX playlist etc.) and then drags it into the channel where it will be played out.
4. The operator can now edit the element by right-clicking and selecting **Edit**.

Editing elements

Common for all operations is that the changes done on the elements being edited are done 'live' on the elements in the Media Sequencer. They are saved immediately and it is not possible to undo.

✓ **Tip:**
Copy an element by dragging it and pressing **CTRL**.

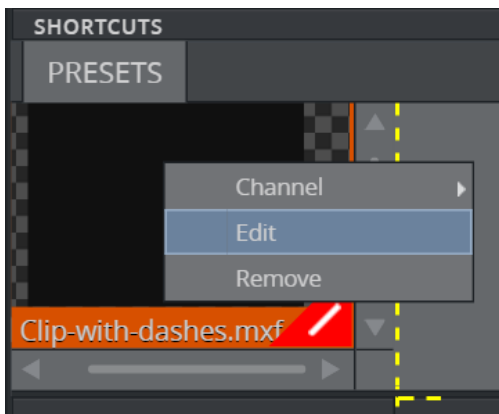

Setting in and out points in video clips

The operator can scrub through video clips and set new in or out points.

1. Drag a video into the channel where it will be played out
2. Right-click the video and click **Edit**
3. Scrub in the timeline to where you want to set an in point.
4. Click the Set Mark In icon or press the **i** key to set an in point

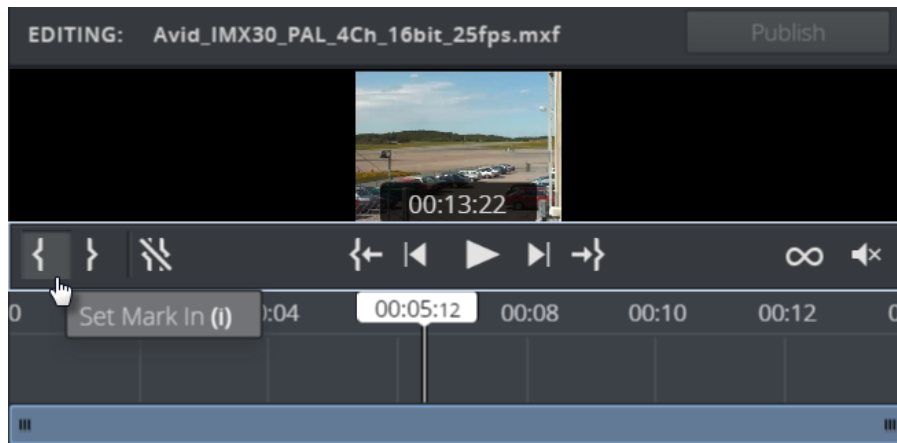

5. Click the Set Mark Out icon or press the **O** key to set an out point

See Also

- [Editing Videos](#)

Zooming and cropping images

The operator can add a zoom or crop effect to images.

1. Drag an image into the channel where it will be played out
2. Right-click the image and click **Edit**
3. Click either **Crop** or **Animation**

See Also

- [Editing Images](#)

Editing graphics

For graphics, the operator can fill in data into the fields exposed by the scene designer.



6.3 Preparing And Playing Out Content

This section will give you information about:

- [Preparing content](#)
- [Playing out content](#)

6.3.1 Preparing content

Initializing

Graphics should be initialized before the broadcast or event. Initializing means that the renderer will load into memory all resources needed to play out the graphics, so they will appear instantly when taken on air.

Initialize a show

To initialize the show, click the **Initialize** button. If you hover the mouse pointer over the button, the progress of the initialization will show in the tooltip.

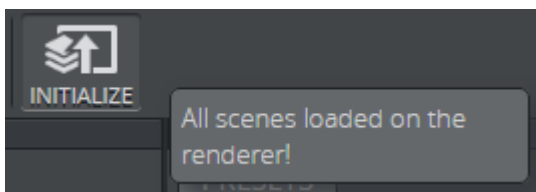

✓ **Tip:**
Initializing during a broadcast may impact scenes playing on air.

Initializing elements

It is possible to initialize single graphic elements in Viz Multiplay by right-clicking the graphics and selecting **Initialize**:

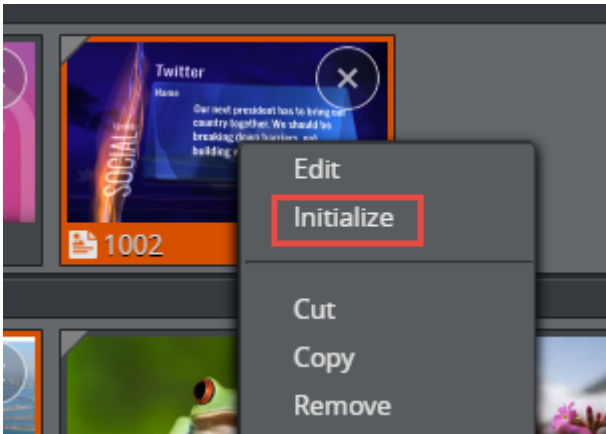

⚠ **WARNING**
Initializing single elements will probably affect the frame rate on the renderer. Flickering or frame drops can happen.

GUI feedback

The colored symbols in the upper left corner of the elements in the Media column will indicate whether the element is not loaded (gray), partially loaded (yellow) or fully loaded (green) on the renderer.

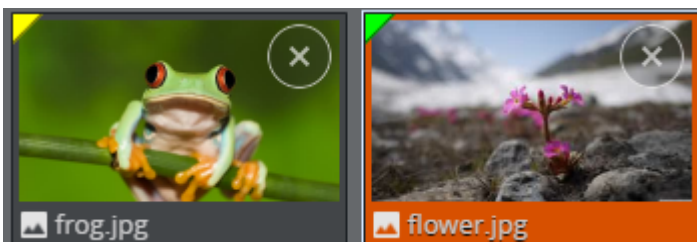

Clean up the renderer

Clean up all video walls or a particular wall in a profile. Cleaning up a wall unloads all the resources from the memory of the renderer, which may be necessary periodically when the system is off air.

See Also

- [Cleanup](#)

Arming

You can arm elements, which means preparing them to be played on air, in Viz Multiplay. Armed videos are prepared by the MSE, so the first frame is ready in the renderer. Images and graphics are not pre-loaded in any explicit way. To arm elements, disable 1-Tap mode so the Armed column becomes visible.

Armed elements are visible in all Viz Multiplay clients connected to the same MSE. If two operators want to arm their own private content on the same channel, ready to be played out, they will conflict. To resolve this - it is possible to select different workspaces for the two operators. Armed elements are visible per workspace - so if the first operator has activated his own workspace, his armed elements are not visible for the second operator in another workspace.

6.3.2 Playing out content

There are several ways of playing out elements in the renderer. The simplest way is to click an element, which sends it to the armed column or directly on air if 1-Tap mode is enabled.

✔ **Tip:**
It is possible to select elements manually from one or more groups and click **Take Selected** or **Arm Selected**. You can de-select elements by holding down the **CTRL** key.

Viz Multiplay also has another, more story-centric way of playing out elements:

1. Organize your material in groups, for example one group per story.

✔ **Tip:**
Each group can have one or more elements placed in the order they will be played on air. Elements can also be assigned to the channel where they should appear.

2. The first element in each channel will be selected when the operator clicks a group (story)
3. Now all the selected elements can be played out or armed by clicking **Take Selected** or **Arm Selected**
4. The selection now jumps to the next element in each group
5. When this procedure is repeated, Viz Multiplay can be used as a tool for sequential payout of elements ordered in a story-centric fashion.

✔ **Tip:**
There should always be a preset on air when using Viz Multiplay with video wall presets. The preset element plays out in the middle layer on the main channel of the renderer (normally host:6100). The GFX channels will not show without a preset on air.

6.4 Setup And Configure Single And Multiple Video Walls

This section deals with creating a profile and setting up and configuring the layout of one or several video walls representing the physical screen setup at the location. Using a separate Viz Engine as an external preview for the video wall is also covered.

A profile can conceptually be seen as a studio, or a physical location where you want to control content on a set of screens. The profile can have one or more video walls - combined walls or single walls, or both.



Tip:

The GUI in Viz Multiplay can quickly be crowded with a lot of GFX channels if a profile containing several video walls. In that case, creating different workspaces to hide channels can be a good idea. The workspace is a private setting per Viz Multiplay client.

This section covers the following topics:

- [Get started with one video wall](#)
- [Screens with different sizes and resolutions](#)
- [Combine video walls](#)
- [Setup and use external preview](#)

6.4.1 Get started with one video wall

This section cover setup and configuration of a video wall without using an external video wall display controller. If you for instance use one or more Datapath Fx4 display controllers, see [Using Datapath Fx4 display controller](#).

This section covers the following topics:

Set up profile and video wall

1. Click **Settings > Profiles**
2. Create a profile by clicking the **Add (+)** button in the bottom of the Profiles list



3. Enter a name for the new profile
4. Create a video wall by clicking the **Add (+)** button in the bottom of the Video Walls list
5. Enter the hostname of the Viz Engine driving the video wall, the number of screen rows and columns the video wall consists of (this must match the NVIDIA Mosaic settings), and how many GFX channels you need to use.



Note:

Currently, the Viz Engine supports up to 16 GFX channels, and you need to license the number of channels you want to use. Do not enable more than you need. The number of GFX channels does not need to match up with the total number of screens you have.



Tip:

Remember also to enable GFX channels in the Viz config file. See the [Viz Engine Administrator's Guide](#) for more information.

6. Enter an approximate number for the screen width and height.

Note:

These numbers can be in any units (mm, cm, pixels etc.). They are just relative numbers used to calculate where the physical pixels should be drawn. A good practice is to use pixels.

Info:

The screen width and height are the dimensions of the physical rendering area, not including the frame around the screen.
The bezel width and height is half of the horizontal and vertical distance between the screens.

7. Bezel values must first be set in the NVIDIA Mosaic settings. When that is done, the GPU knows how large the total output dimension is. The larger the gap between the screens, the larger output dimension. The point of setting bezel values in Viz Multiplay is to guide the preset designer on where the screens are located in the physical wall, and where the 'dead' areas are.
The offset values are only used when combining two video walls into one big area. Leave the values on 0 (zero) for now.
When you Click **OK** and confirm in the next warning dialog box, Viz Multiplay will create the necessary Viz and Video engine outputs in the lists to the right, and also add them to the newly created playout channels for this video wall. Notice that the channel list now has a channel called A (the main channel) and a number of GFX channels.
8. Set the main channel as Viz program. All elements not containing an explicit channel will now be played out on the program channel.



Adjust screen dimensions and bezels numbers

Now that we have a profile with a video wall setup, we should adjust the numbers we entered for screen dimensions and bezels, so our content matches the physical screens. This is important if you have a large bezel value, or use multi video walls. If not, you can skip this step.

We can adjust the configuration visually in the Studio Editor, but first we need to have something to play out in our GFX channels, so we visually can confirm where the pixels end up on the screens.

Instructions:

1. Create a new show by clicking **Open**
2. Click the **Add (+)** button. Viz Multiplay will create a show with three default playlists (see previous chapter) and one video wall config preset you can use to do the wall adjustments.
3. Click **Ok**
4. To use the new show together with your profile, click **Settings > Profiles**
5. Click the **Activate** button.

**Tip:**

Activating a profile is a Media Sequencer operation. You now activate your show in this profile for all clients while the show is open. Activating a show in a profile means that the Media Sequencer starts monitoring resources in that show, so the operation is potentially resource demanding if the show is big and contains lots of media assets. Your show can only be active in one profile.

6. You should now see one group for each channel in the [Media Column](#)



7. You now have a videowall tab with one group and one preset called '**config**' in the Sources pane in the bottom left corner. Use this preset when you configure your video wall.

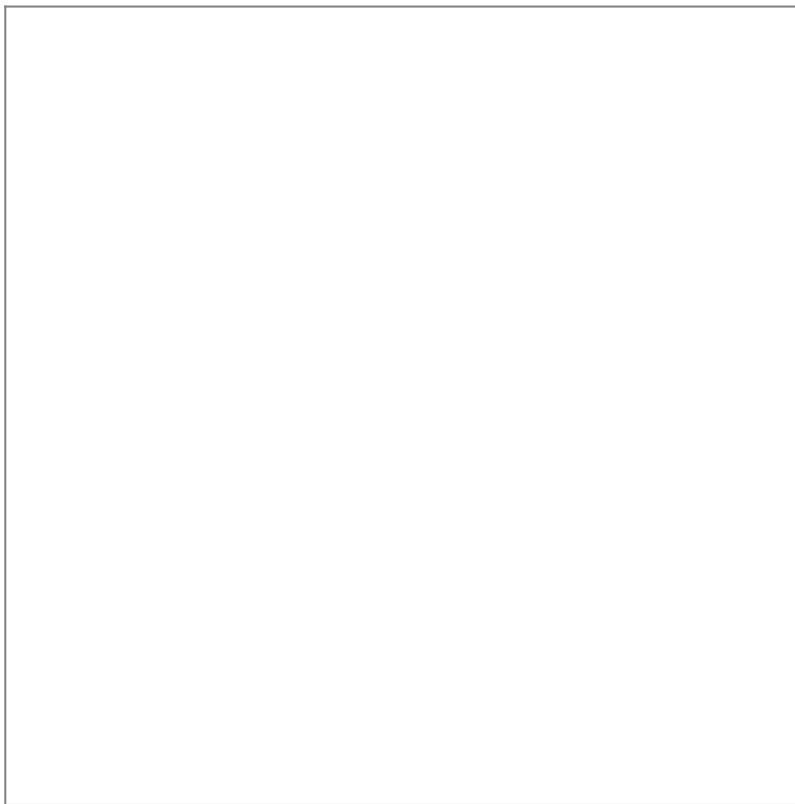

8. In the Sources pane, click the Videowall tab
9. Right click the '**config**' preset and enter the Video Wall Designer for designing the layout of the GFX channels

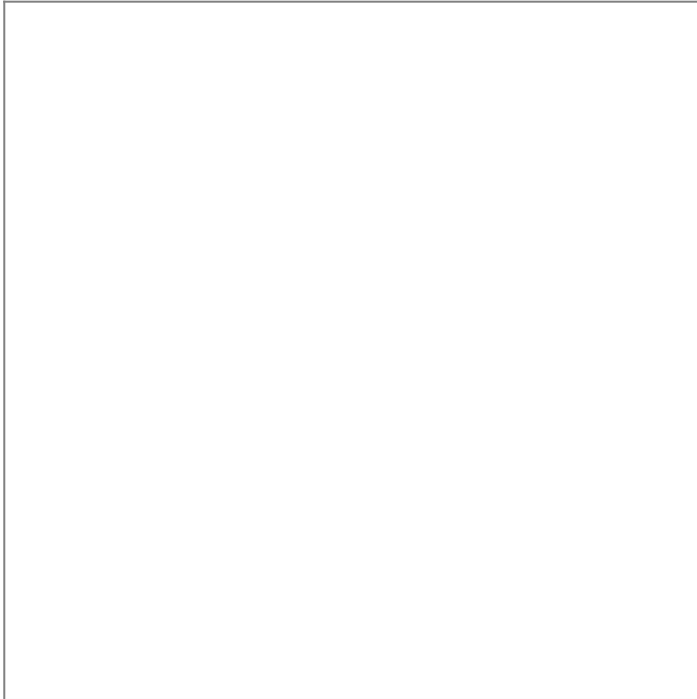

10. The GFX channels will not match the physical screen setup the first time you open the Video Wall designer. Right click a GFX channel and select **Hide all channels**.
11. Drag channels one by one from the Channel Bin and drop them onto the areas marking each of the screens.

✓ **Tip:** For the configuration preset, it is smart to have one GFX channel per screen. This allows you to see how the physical output of each screen matches with the configuration.

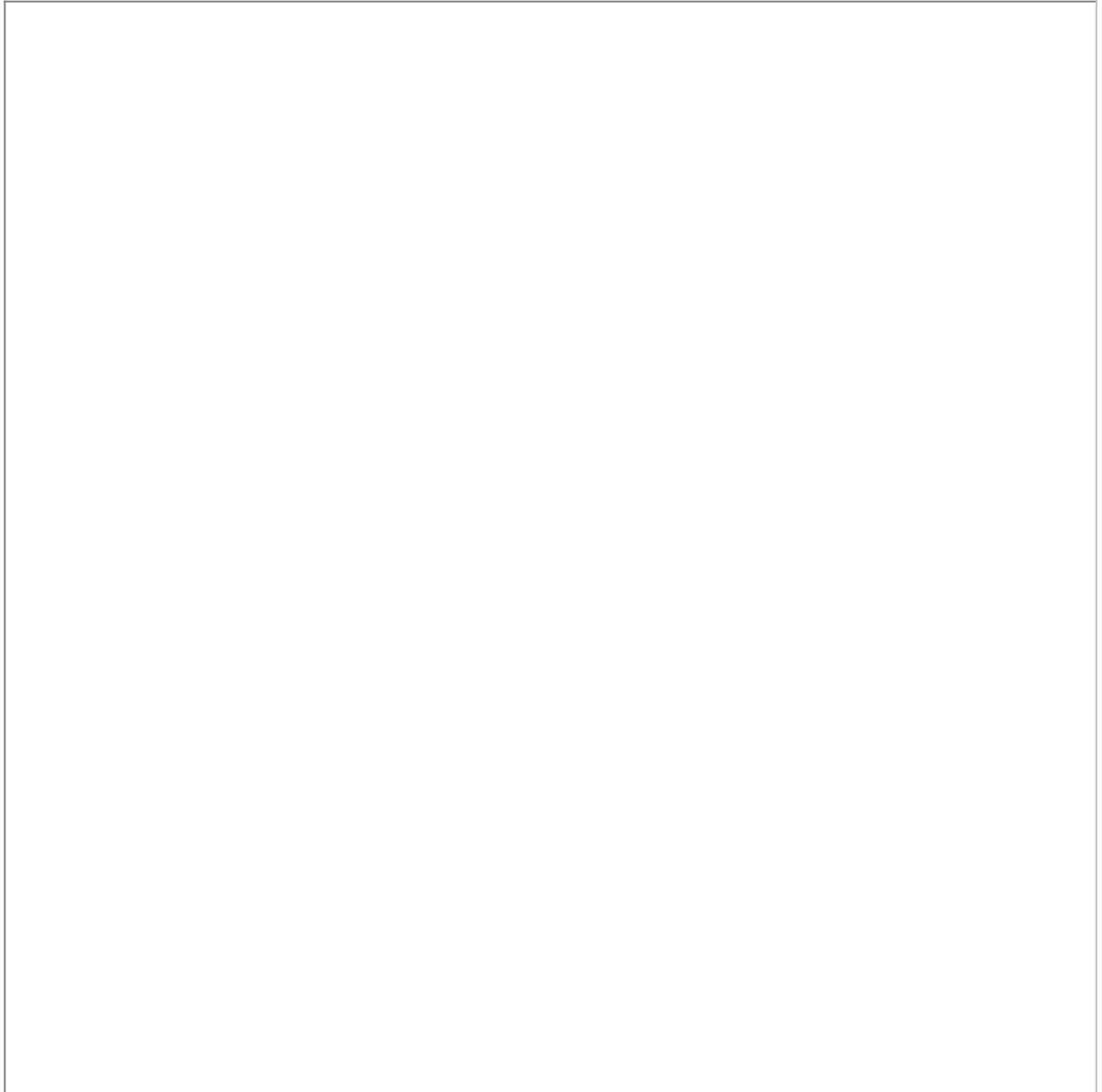

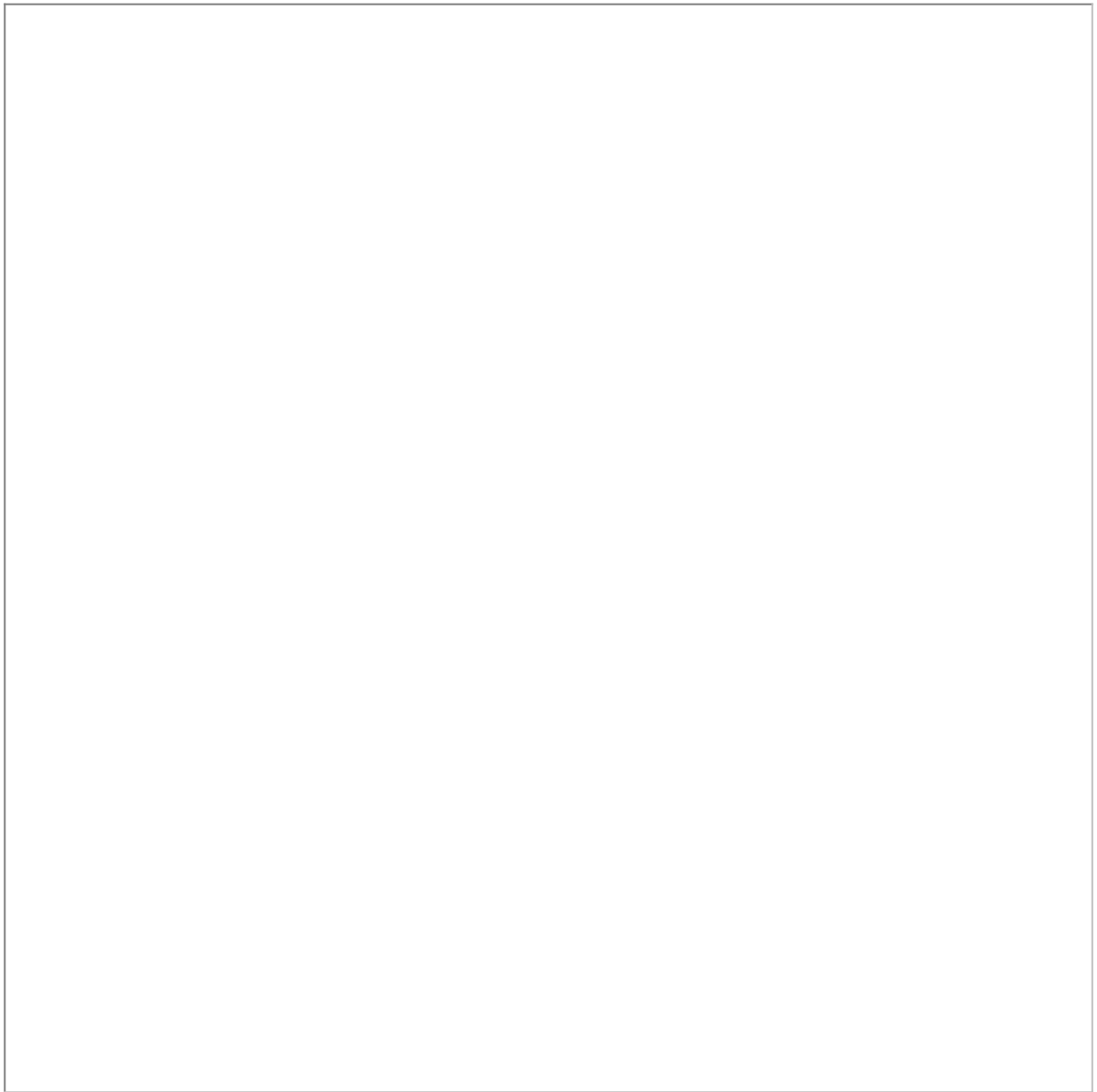

12. Save the preset by clicking the **Save** icon



13. Click **Close**

Take presets on air

You are now back to the main GUI in Viz Multiplay, and you have created one default config preset. It's time to take this on air on the main channel:

1. The Videowall tab is a source for different presets, pre-made to quickly be used in a show.
2. To play out a preset, drag it onto the PRESETS group in the Shortcuts bar

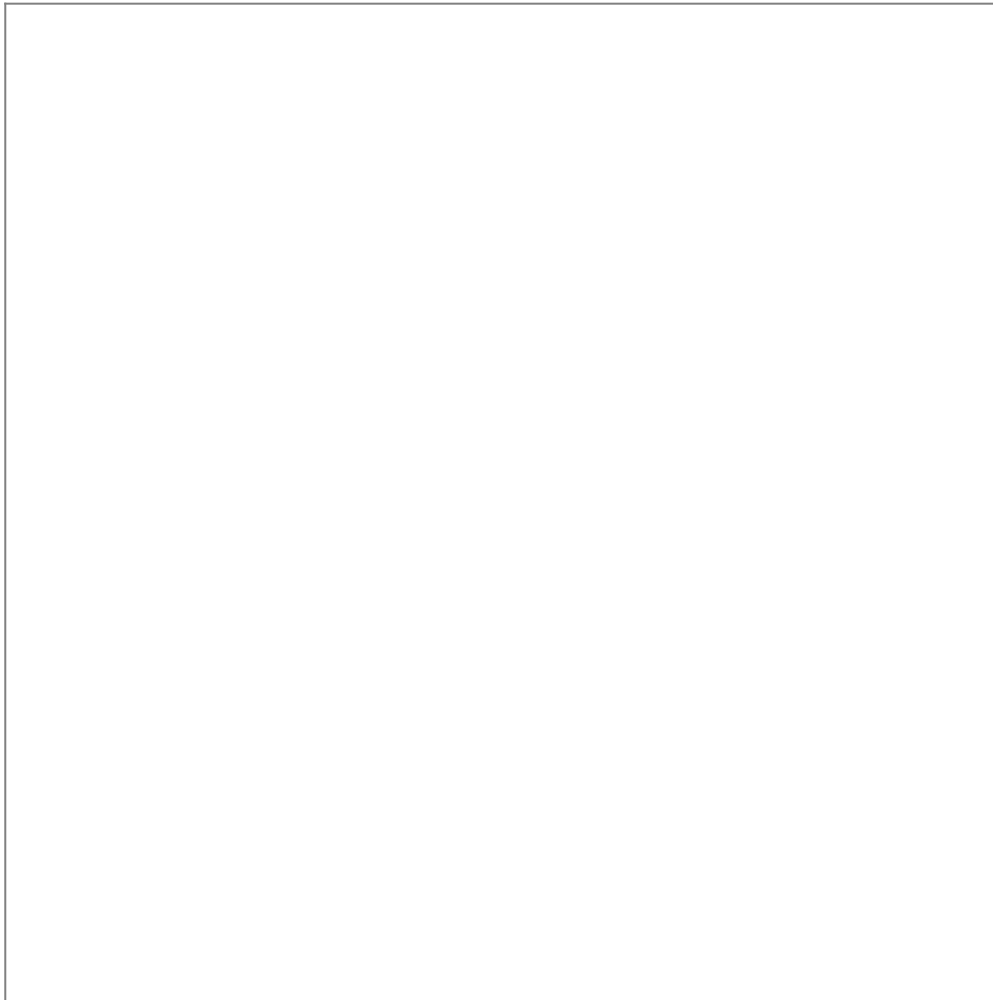

3. Click it and verify that the preset now appears in the Armed column
4. Click **Take** and verify that it appears in the Program column



Tip:

To ensure the preset is on air also watch the Media Sequencer console (it is smart to run the Media Sequencer in a console during configuration). Also watch the Viz Engine console, preferably with the Viz commands enabled.

Send Viz commands

In the Video Wall designer, click the cogwheel.



This will open Advanced settings:

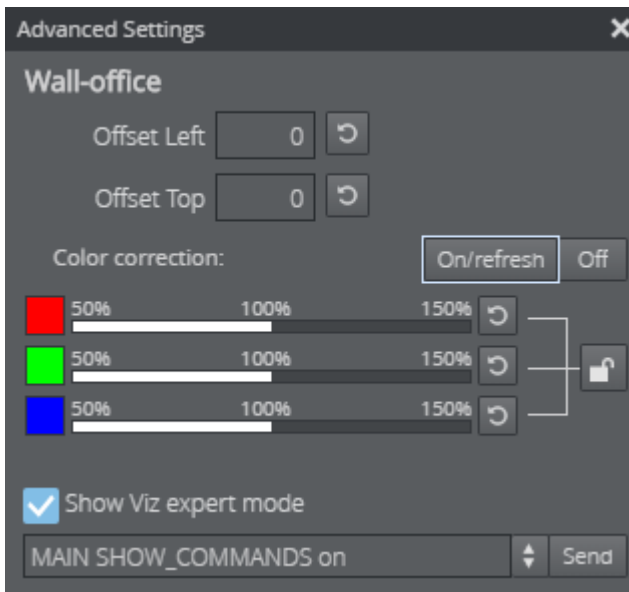

In this window the offset of the wall (if combining more than one Viz Engines into one wall), send Viz commands and color correct the whole wall. See [Advanced Settings](#).

Color correct output

You can do color correction on the output from the Nvidia card. This feature requires Viz 3.8.2 or higher. RGB intensity can then be controlled directly on the GPU. This works by letting Viz Multiplay send the SCANOUT_INTENSITY SET (r,g,b) command to the Viz Engine, and the engine then sets the intensity values directly on the Nvidia graphic card.

Tips:

The color correction mode is not remembered after the Viz Engine is restarted, so you need to click "On/Refresh" if you restart Viz Engine. The numbers are remembered so you do not need to do the color tweaking again.

Enable the Viz expert mode to send Viz commands directly from Viz Multiplay. The dropdown is pre-filled with some common commands, including enabling the performance bar, toggling commands on or off in the console and sending the RENDERER JOIN_SWAPGROUP 1 command. This is necessary for single walls also if you want to send exact values for the color correction, if the GUI slider is not accurate enough.

It is crucial that you test-run your scenes, clips and live sources on the video wall before going on air. Use the performance bar in the Viz Engine to get an indication on how the performance is. To enable this, use the Viz expert mode to send the RENDERER SET_PERFORMANCE 1 command. A performance bar in the bottom of the renderer window will appear, indicating how many fps the system is capable of rendering.

6.4.2 Screens with different sizes and resolutions

The Nvidia Mosaic setup only supports output to an X * Y matrix of screens with similar resolution. Nvidia also recommends that all the screens in a Mosaic video wall should be the same model. From one GPU you can get 4 outputs. It is not recommended to add more GPUs to the computer. The recommended way of combining more screens, and/or different aspects and resolutions, is to use an external video wall display controller, like Datapath Fx4.

The principle is that the Viz Engine draws all its output on one big renderer space, where the different areas are defined by the size and position of the GFX channels. On the hardware side, the output from the GPU (combined with Nvidia Mosaic or not), fed into one or more display controllers, will distribute the pixels to the physical screens.

The screen layout given in Datapath Fx4 controllers can be imported into Viz Multiplay to create Active Areas (snap points) for the GFX channels when designing the walls.

See [Using Datapath Fx4 display controller](#).

6.4.3 Combine video walls

In Viz Multiplay multiple video walls can be merged into one studio. Each wall is controlled by one Viz Engine, and content in a GFX channel can then span over both walls. Each Viz Engine plays out the same content, but different parts of it.

One use case for this feature can be to let content “fly” from wall to wall by switching between presets where the GFX channels are placed respectively on the first and second wall, or simply to have content span over two walls.



Warning.

This feature should be tested thoroughly on actual hardware and actual content. Two physical video walls driven by two Viz Engines can have different physical output and performance. Videos will not be frame accurately synced.

Click **Settings > Profiles**

1. Select your profile
2. Add a new video wall by clicking the Add (+) button in the Video wall list.
3. In the Video Wall dialog box, choose the first video wall in the **Merge Into** dropdown.

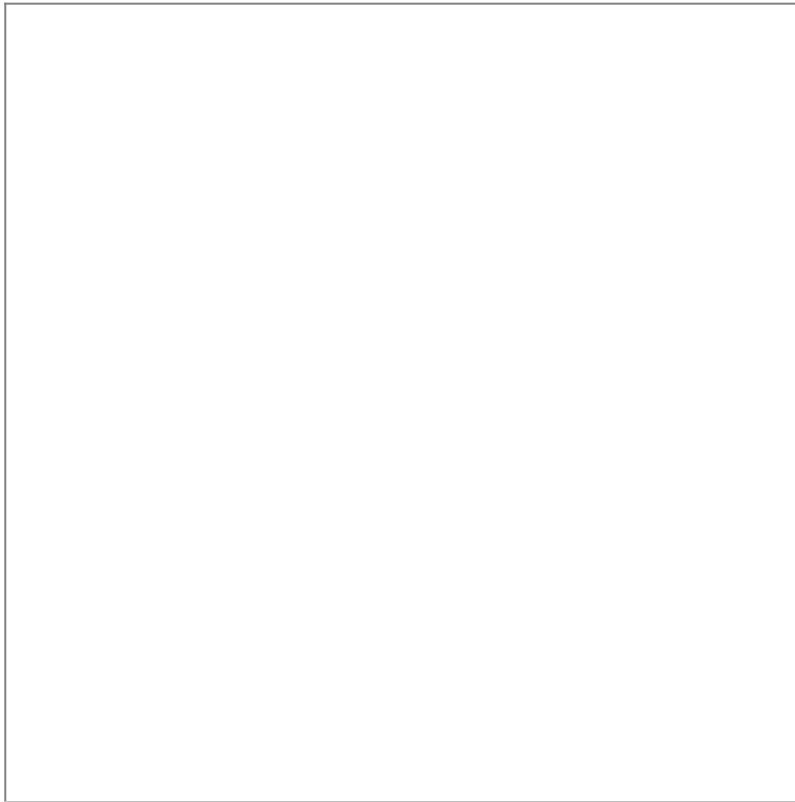

4. Enter values into **Wall Offset Top** and **Wall Offset Left**

**Note:**

These values are just relative numbers in any units. They indicate where your second video wall is placed relative to the first one. Do not worry if you do not provide accurate numbers now, you will use the Studio Editor to fine tune them visually in the next step.

5. Click **OK**
6. A notification appears confirming your decision to create and merge video walls.

**Note:**

Now this second wall will share the main and GFX channels with the first wall, so these settings will be disabled in the dialog box.

7. Click **Yes**.

Adjust the layout on the new multi video wall

1. Open the Video Wall Designer for the config preset (In **Sources** panel click the Video Wall Tab and then 'config' in the list. Then right click the config preset and click Video Wall Designer.)
2. The GFX channels will now not match the physical layout. Remove them by right-clicking a GFX channel and select **Hide all channels**
3. Adjust the GFX channels to fill out each of the screens in the physical layout, if you have enough GFX channels

- The example below has two walls are used in the example below: a 4x2 wall and a 3x1 wall below. The numbers we entered in the config did not match up with the physical locations of the screens, so we have to use the Studio Editor to fine tune it.



- Go back to the main view and play out content in the relevant GFX channels to see how it fits the physical output.
- Enter the [Advanced Settings](#) and adjust the offset until the output matches the screens.

**Tip:**

Remember that you can adjust values in the Studio Editor by dragging them sideways with the mouse button.

**Note:**

In practice, you know the layout of the physical screens before you start the configuration in Viz Multiplay. Take some basic measurements of screen size and wall placement and enter these numbers in the **Edit Video Wall Setup** dialogue box in **Settings**. Create the walls there first and then use the Video Wall Designer and the offset in Advanced Settings to fine tune the values.

6.4.4 Setup and use external preview

The [Armed](#) column will give you a hint of what is ready to be played out, but not an accurate preview. If you want a real Viz Engine preview of the content ready to be played out you must configure an external Viz Engine as a preview. Depending on how much hardware you have available, this preview can be a simple VGA version of the Viz Engine, a Video Engine with a simulated Matrox hardware (a Matrox X.Open dongle), or a full Viz Engine with high end graphic cards and NVIDIA Mosaic.

Keep in mind the following:

- It is possible to preview live sources if your preview engine is a video enabled Viz Engine with a Matrox video card. In this case, the SDI in signals must be split to go into both the video wall and the preview engine.
- Viz Trio's local Viz preview can also be used as an external preview. But it is mainly used for testing because Viz Trio's local preview function (reading pages) and the video wall preview will conflict.

To setup and use external preview

- Click **Settings > Profiles**
- Click on a profile and create a new video wall inside of it
- This video wall will represent the preview wall. If you use a Viz Engine with one screen to preview the video wall, enter the same amount of GFX channels as in the main wall. However, set the rows and columns to 1 and name it, for example, *Preview Wall*



- Click **OK** to generate the channels for the preview wall

Note:
These will not be visible in the main playout GUI

- Double click the main video wall in the Video Wall list in your profile
- Select your newly created preview wall in the **External Preview** combo box



- Click **OK**

Now, whenever you arm presets and elements (with 1-TAP mode disabled), these elements are played out on the preview engine. In this way, the preview engine can act as a “real” preview for the main wall, depending on what kind of hardware you use as a preview wall.

- Go to **Settings > General**. Set the **Extra Armed button** to **CONTINUE**:

Extra Armed button : 

This will make an extra button appear in the Armed column. Whenever an element is armed, it is taken on the preview engine. Clicking CONTINUE will now continue the element on the preview engine. In this way, you can preview a full sequence of stop points in a graphics on the preview engine before it is taken on air in the program engine.

6.5 Presets

Presets describe the layout of the GFX channels in the video wall. Each GFX channel can have either a clip, a graphic element or an image. GFX channels are not bound to the size and dimensions of the physical video wall setup. A preset can have GFX channels spanning over several screens, and vice versa - several GFX channels can be placed inside a physical screen. GFX channels can also overlap each other. In addition, they have a Z-order, which allows content to be combined in GFX channels that are placed on top of each other.

The definition of presets encompasses the following:

- Presets are regular graphic elements playing out the DynamicChannel scene, which keeps track of the positions of the GFX channels.
- Presets are pages in a show that are not technically tied to one special video wall configuration in a profile. Rather, in reality, the presets of a show will not be usable for a different video wall setup. Therefore, the presets that are created in a show should only be used together with one special profile.

The following topics are covered in this section:

- [Creating presets](#)
- [Using your new presets](#)
- [Fine tune size or position of GFX channels](#)
- [Workflow without using the VideoWall tab](#)

6.5.1 Creating presets

1. Start by creating a video wall setup in a profile.
2. Create a show.

✓ **Tip:**
For instructions on creating a show, see [To create a new show with Viz Multiplay](#)

3. Activate the profile.
4. When you create the new show, Viz Multiplay automatically creates a special playlist for presets. This will appear under the Videowall tab in the sources pane.



5. If you want to organize your presets in groups, create a few new groups in the Videowall playlist, or keep the existing **Default** group.



6. Create some presets in one of the groups by clicking the **Add (+)** button:



Note:

The presets created in the video wall playlist should be seen as templates. They cannot be played out directly, unless you are in the Video Wall Designer. The purpose of this step is for someone to prepare a set of basic presets that can be used later when the content of the show is created. The presets are created default with a 4x2 layout.

7. Right-click a group to connect it to a video wall in the active profile.

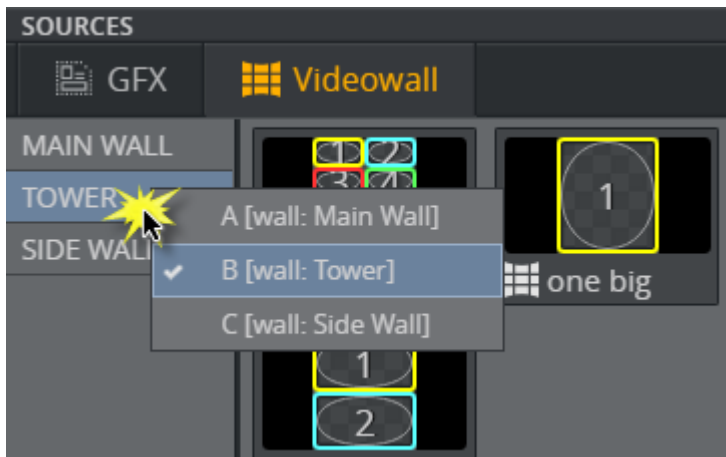

6.5.2 Using your new presets

1. Right click them in the Videowall tab and enter the Video Wall Designer.
2. In the Video Wall designer, you can reorganize the layout of the GFX channels.
3. Save the presets when you are finished.

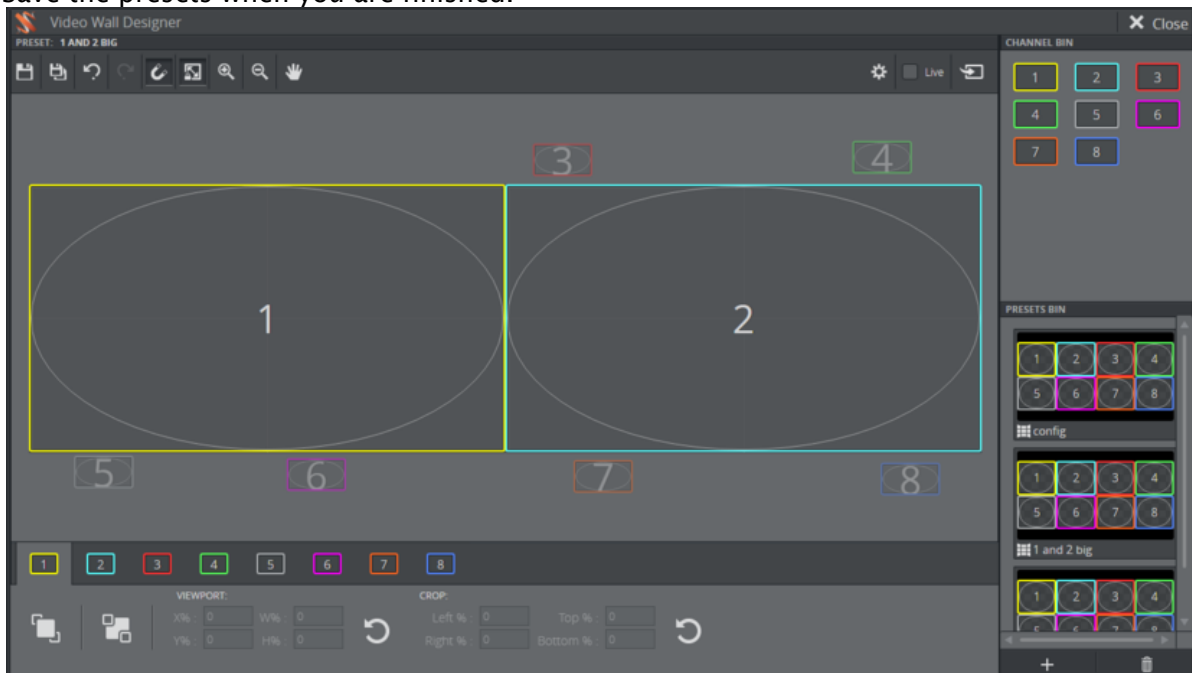

✓ **Tip:**
Play out the content in the renderer in all the GFX channels before adjusting the GFX channels in the Video Wall Designer. This allows you to click **Take** or check the Live box from within the Video Wall Designer. This will automatically adjust the positions and dimensions of the content when working in the Video Wall Designer.

✓ **Tip:**
If you have GFX channels that should be invisible in a preset - do not disable them. In terms of performance, it is better to drag them outside the video wall area and/or resize them to a smaller size.

6.5.3 Fine tune size or position of GFX channels

You are left with some preset templates with different layouts after working with the presets in the Video Wall Designer.

If you need to fine tune the size or positions of the GFX channels, do the following:

1. Enter the Video Wall Designer and click the Take button.
2. Return to the main GUI in Viz Multiplay.
3. Play some content out in each GFX channel and enter the Video Wall Designer again.
4. Now check the **Live** box and fine tune the GFX channels.
5. The output on the physical screens will update live as you adjust the GFX channels in the Video Wall Designer.

6.5.4 Workflow without using the VideoWall tab

This workflow is more suitable when you have a fixed set of presets that can be created and prepared before the broadcast or event, and when the Viz Multiplay operator does not need to change any content.

1. Create a show.
2. Drag the default preset from Videowall tab into your shortcuts playlist.

⚠ **Note:** Optional: Go to **Settings > General** and select **(No playlist set)** in the **Videowalls** dropdown. Now the Videowall tab disappears from the **Sources** panel and appears in the **Show** panel.

3. You now have one preset in the shortcuts playlist. Right-click it and select Video Wall Designer.
4. Make your adjustments and click the **Save As** button to save more presets.
The end result is the same in this workflow: A set of presets in the Shortcuts bar, ready to control the layout of the video wall.
5. If you want to store the shortcut bar presets in the Videowall tab, drag them from shortcuts into the video wall tab. This will create a copy in the Videowall tab.



See Also

- [Shortcuts Bar](#)

6.6 Creating Prefilled Walls

Presets represent the layout of the video wall. Each GFX channel has a size and a position. When you change a preset on air, the content of each GFX channel stays the same and the GFX channel moves to the new position.

Imagine a scenario where you play out both a layout and content at the same time. You may have a fixed set of images, clips or graphics for a special occasion, such as an opener for a show. Or you prepared a set of content for a news story. In that case, you want to prepare both a preset and its content and save it as a filled preset, and let the Viz Multiplay operator play it out with one click or tap.

The following topics are covered in this section:

- [Common workflow](#)
- [Adapt the GUI to prefilled walls](#)

6.6.1 Common workflow

The following is an example workflow:

1. Create a new group in the shortcuts playlist

⚠ Note:
The shortcuts playlist already contains one group called **Presets**. Now you want to have an additional group for your pre-filled walls. This group will appear as a tab in the Shortcuts bar.

2. Drag a preset from the Videowall tab to your new group in Shortcuts, or the main channel (usually channel **A**).
3. Right-click the preset and select **Edit Content**.
4. You can drag elements from the different tabs (Media, inboxes, the GFX playlist) from the editor that appears down to the GFX channels in the video wall.

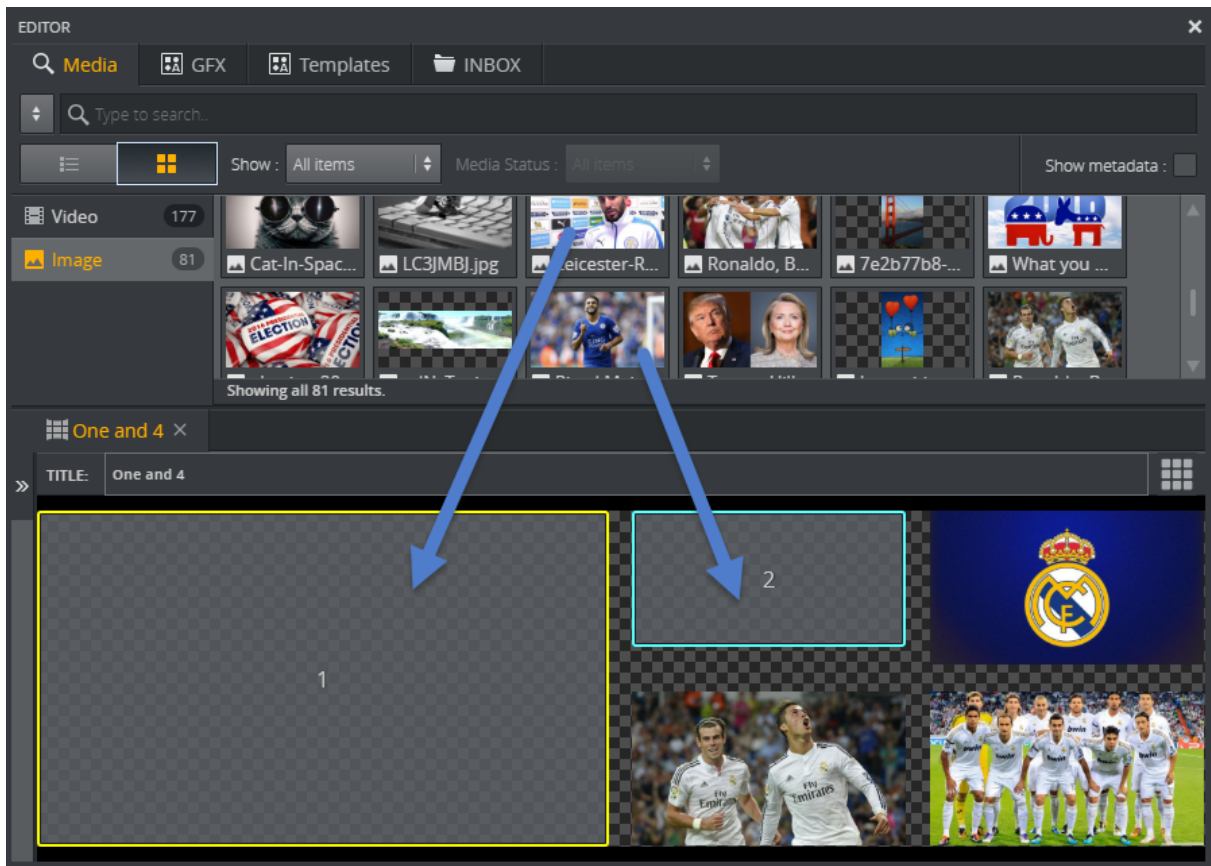

5. Edit individual elements in a video wall by clicking the **play symbol**, alternatively right click and select **Edit** or simply double click content in a GFX area.

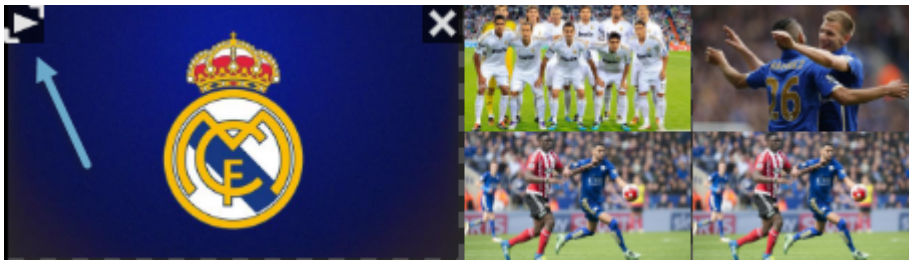

6. Sometimes a GFX area can be outside the editor, or two GFX channels can partly or fully overlap. In that case, hold **SHIFT** down to reveal the GFX channels numbers behind the content. and click the **Reveal**-button to change the view to a secondary view where all the GFX channels are stacked out:

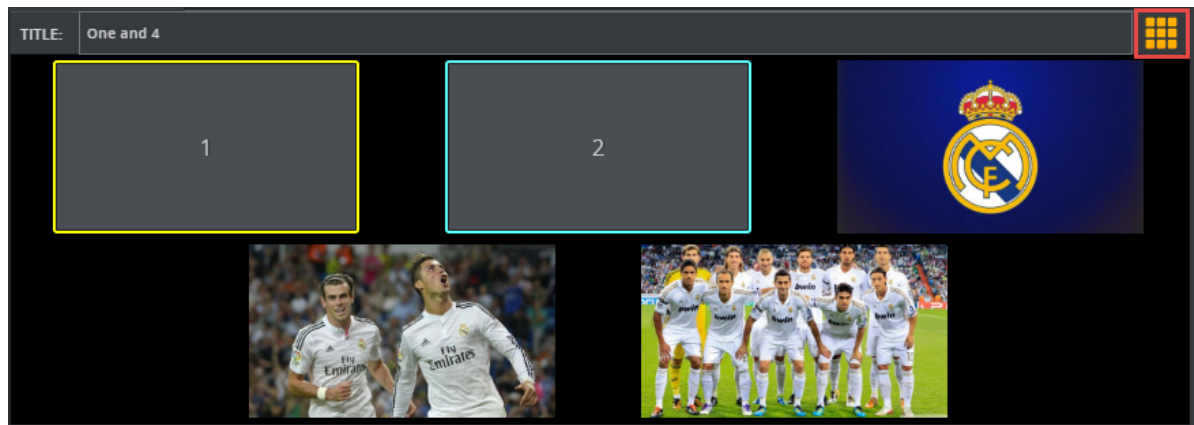

7. Finally, close the editor when the video wall preset is filled (partly or completely) with elements.
8. In Viz Multiplay, the preset thumbnails in the **Walls** group in the shortcuts playlist should now reflect the content put into the video wall preset.

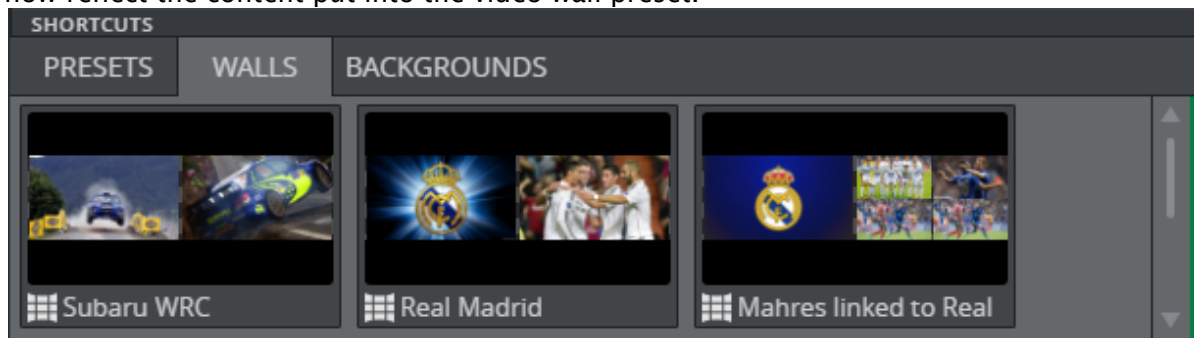

Tip:

It is possible to fill only one or some of the GFX channels in a filled preset. The existing content on air of the non-filled GFX channels will then stay on air when a partly-filled preset is played out.

6.6.2 Adapt the GUI to prefilled walls

A nice workflow is to create a workspace where you hide all GFX channels and only show the main channel. In addition, remove the shortcuts playlist and increase the thumbnail size to 200. Then you can drag presets from the Videowall tab over to the A channel and fill them with content. You will then have a GUI where the operator can control full walls with a single tap.

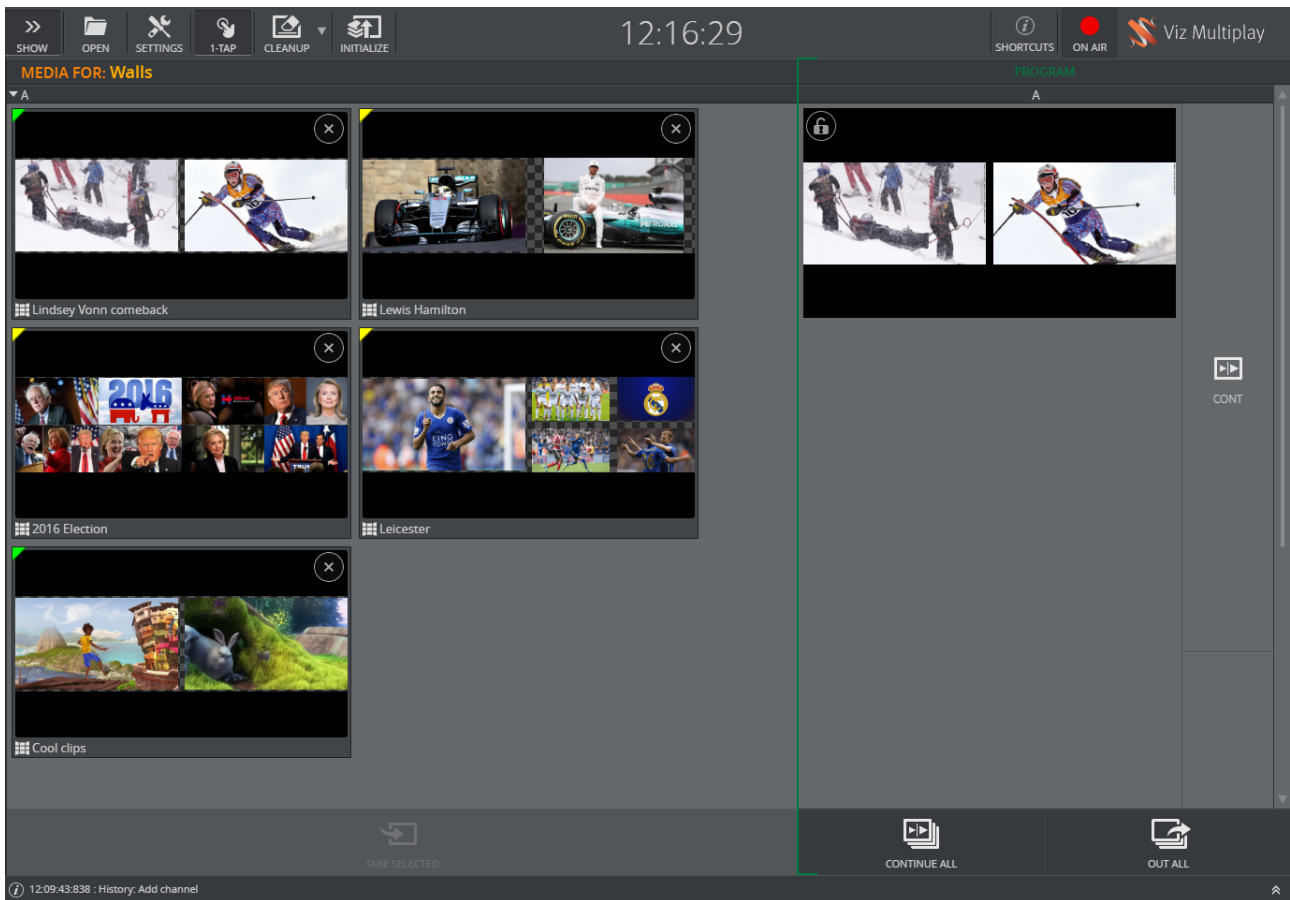

Only the main channel is visible in this workspace, and the thumbnails have a maximum size. With one click or tap, the Viz Multiplay operator can now toggle complete walls with layout and content.

6.7 Working With Viz Pilot And MOS Content

This section covers integrating Viz Multiplay with Viz Pilot and MOS playlists. In addition, it deals with setting up a Pilot Data Server directly in Viz Multiplay.

The following topics are presented here:

- [Viz Pilot playlists](#)
- [MOS workflow](#)
- [Pilot Data Server](#)

Definitions and how-to add playlists:

- **Internal playlists (show playlists):** These are owned by the show. They are exported together with the show, and they are deleted when removed from the show. Viz Multiplay automatically creates three internal playlists when creating a new show: Shortcuts (for often used presets), GFX (for source graphics) and videowall (for source presets that can be dragged into the show or into shortcuts).
- **External playlists:** These are playlists created by an external system such as Viz Pilot or a MOS playlist from a newsroom system. These playlists are not owned by the show, but they

are only referred to from the show. They will look like internal playlists, but they will not be deleted when they are removed from the show.

- To add a playlist, click the **Add (+)** button to the right of the tabs in the Show pane. You can now choose between adding an internal or external playlist.

6.7.1 Viz Pilot playlists

You probably have created one or more Viz Pilot playlists if you have already set up your Media Sequencer in a Viz Pilot workflow.

These playlists can be added as external playlists to your show:

1. Click the **Add (+)** button to the right of the tabs in the Show pane.
2. Click **Add external playlist**.
3. Browse to the playlist you want to add and click **Ok**.

Tip:
Organize elements in shows and playlists in groups to ensure that they appear in Viz Multiplay.

You cannot edit the elements in this type of playlist if the Media Sequencer is set up with an Oracle connection to the Viz Pilot database. Then you must use Viz Pilot to edit the elements.

You can, however, edit the elements in a Viz Pilot playlist by right clicking an element and selecting **Edit** if the Media Sequencer is set up to connect to a Pilot Data Server (which can be backed either by an Oracle database or a Viz Graphic Hub). The elements are then put back to the database through an HTTP connection to the Pilot Data Server. The Media Sequencer will detect this change and update the element in the Media Sequencer automatically.

6.7.2 MOS workflow

The Media Sequencer contains one or more MOS playlists if set up in a Newsroom workflow connected to a Viz Gateway. The Media Sequencer is responsible for communicating with the Newsroom system through the MOS protocol and keeping the MOS playlists up to date. The changes are reflected immediately in Viz Multiplay.

These playlists can be added as external playlists to your show:

1. Click the **Add (+)** button to the right of the tabs in the Show pane.
2. Select **Add external playlist**.
3. Browse to the MOS playlist you want to add and click **Ok**.
Initially, the MOS playlist will be empty. To request it from the Viz Gateway, right click the MOS status label and select **Request**.

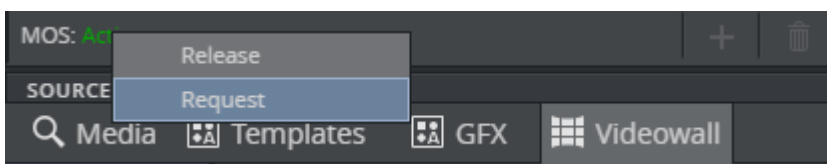

The Media Sequencer will now take ownership of the MOS playlist and update it live whenever the rundown changes.

The MOS playlists are organized in stories (groups), so the elements will be visible in Viz Multiplay. Each story will become one group in Viz Multiplay. Clicking the group will expose the elements in the group, organized per channel. Elements in a MOS playlist are owned by the newsroom system, so they cannot be edited. However, it is possible to drag them from one channel to another channel.

Assign Channel

In Avid iNEWS, you can specify the playout channel by right clicking the item in the story and selecting **Assign Channel**.

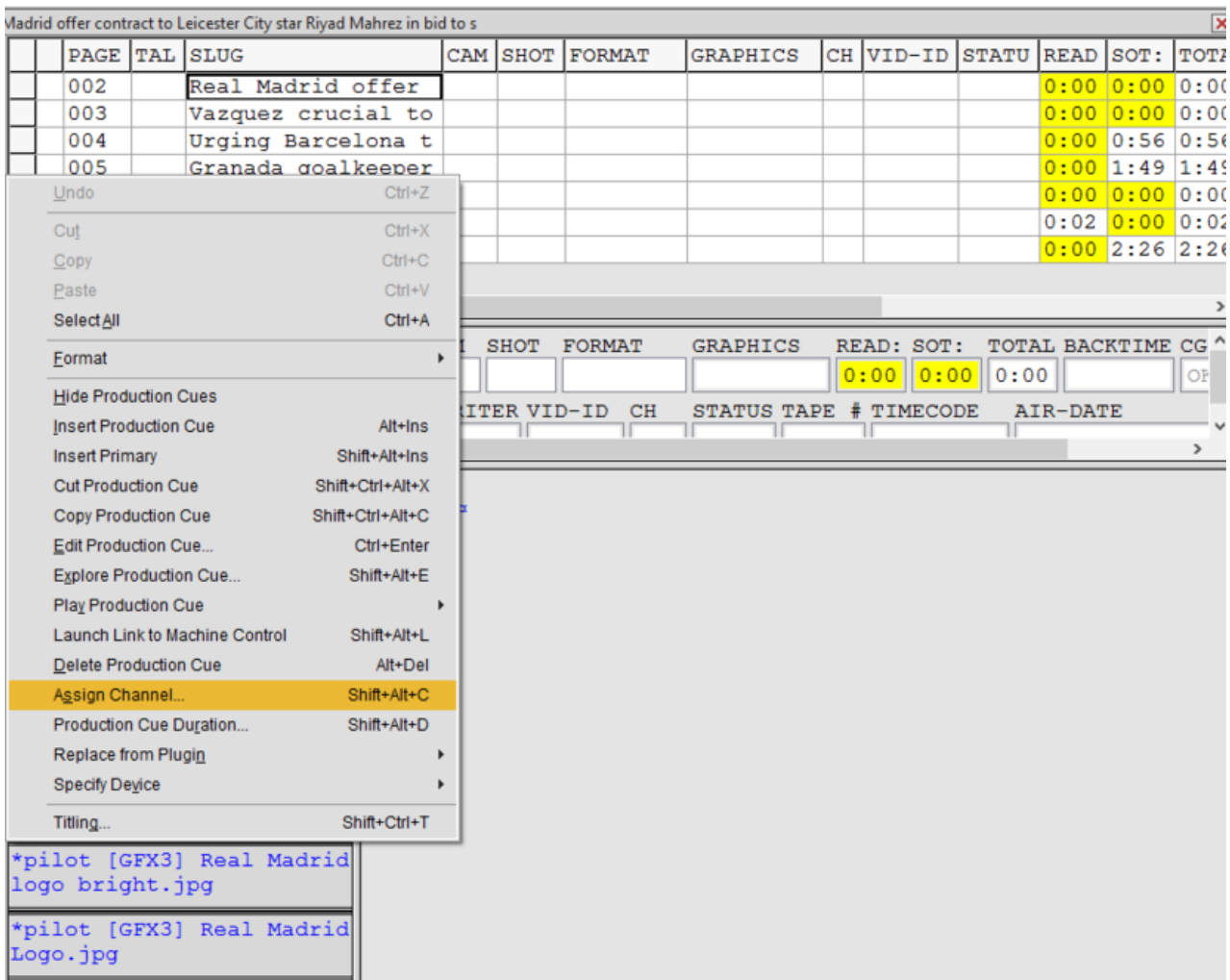

When the Media Sequencer receives the MOS playlist, it sets the channel on the elements so Viz Multiplay can organize them under the right channel in the GUI. This channel must exist in the active profile. Elements without a channel will appear under the channel set as the Program channel.

Write channel to newsroom system

If you drag a MOS element in Viz Multiplay to another channel, it is possible to write the new channel back to the newsroom system. This feature must be enabled with Viz Trio:

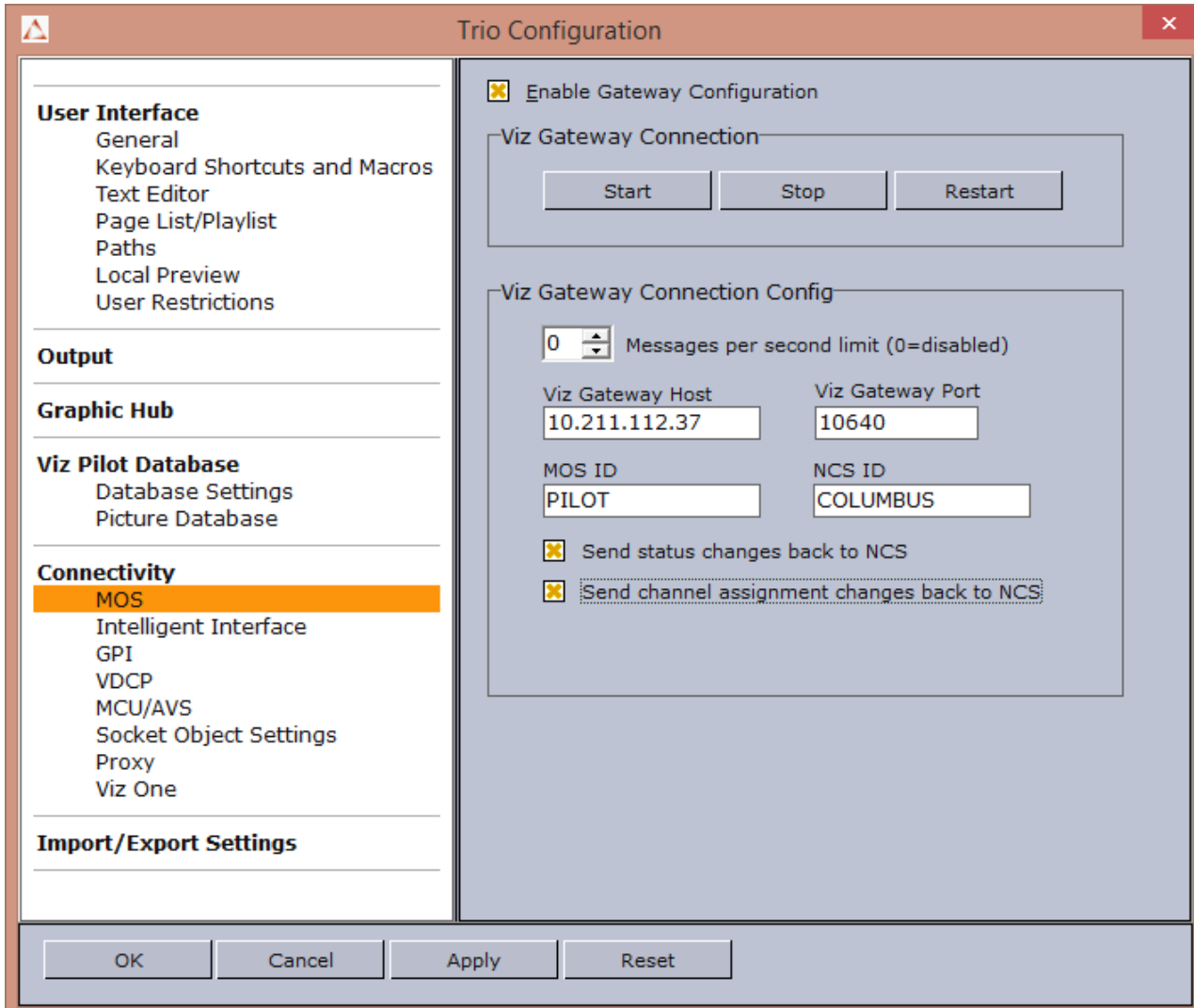

You can release the MOS playlist from the Media Sequencer by right-clicking the MOS status bar and selecting **Release**. The Media Sequencer will stop updating the playlist for all clients connected to this Media Sequencer, so exercise caution when releasing a MOS playlist.

6.7.3 Pilot Data Server

Viz Multiplay can connect to a Pilot Data Server if one is installed on your system. In which case, it can use the graphics directly without using an external Viz Pilot playlist.

To set up this workflow, both Viz Multiplay and the Media Sequencer must be configured to use the same Pilot Data Server.

In Viz Multiplay

1. Go to **Settings > Servers**.
2. Enter the URL or hostname to the Pilot Data Server in the Pilot Data Server input field.

✓ **Tip:**
If you only enter the host name, press **TAB** and Viz Multiplay will auto complete the full URL.

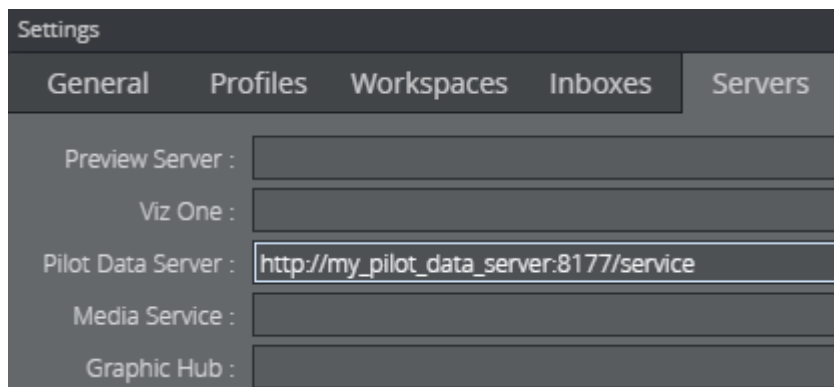

3. The Templates tab will appear in the Sources pane if Viz Multiplay connects to the Pilot Data Server:

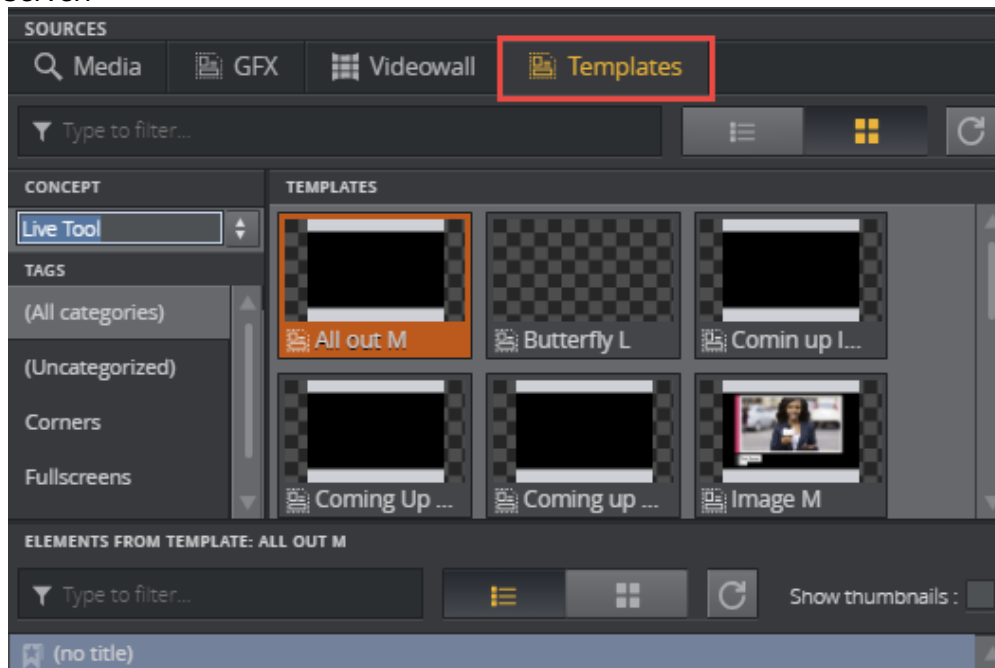

✓ **Tip:**
The Templates tab not appearing after configuring the Pilot Data Server URL in Viz Multiplay probably means that the URL is unreachable. Type the URL in a browser to see if you can connect to a Pilot Data Server.

The Templates tab contains the Viz Pilot concepts and templates. Drag a template over to the playlist area. Now Viz Multiplay will create a new Viz Pilot database element and insert a reference to it into the Media Sequencer. The Media Sequencer is responsible for connecting to the Viz Pilot database and insert it into the Media Sequencer so it can be played out. The Media Sequencer will also keep the element up to date whenever someone changes the database element.

To setup the Viz Pilot connection in the Media Sequencer:

1. Go to `http://mse_host:8580/app/pilotdbconfig/pilotdbconfig.html` in a browser.
2. Then add the host and port to the Pilot Data Server in the config GUI.

 **Note:**
You may have to restart the Media Sequencer.

When you edit the Viz Pilot elements in Viz Multiplay (right click and select **Edit**), the changes are sent directly to the Viz Pilot database through HTTP. The Media Sequencer will detect this change and update the element in the Media Sequencer automatically.

6.8 Using A Switcher

This section covers using a switcher to control elements in the Media Sequencer. The switcher must support the PBus protocol.

A switcher provides an alternative to using the user interface to perform an action such as Take or Out on an element.

 **Note:**
The various actions that can be performed on elements are described [here](#).

6.8.1 Background

The Peripheral Bus (PBus) protocol enables controlling the Media Sequencer from a switcher using a serial interface and a few simple commands. The hardware hookup is a serial line running from the switcher to the Media Sequencer machine. Since PBus is a one-way protocol, data flows only from the switcher to the Media Sequencer. The Media Sequencer supports three commands: Recall, Learn and Trigger.

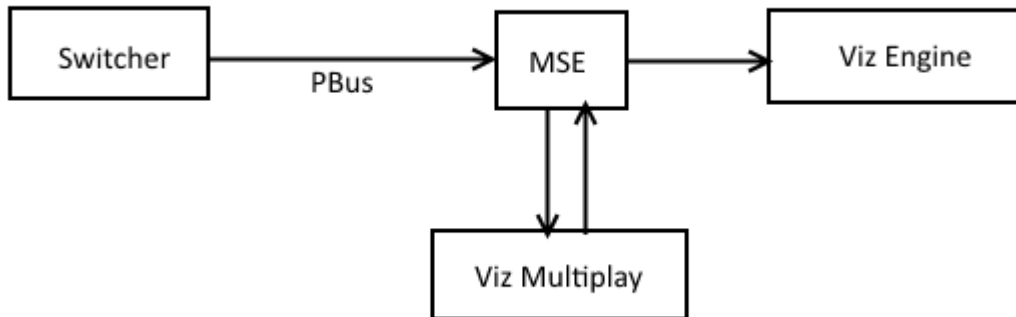

The workflow is as follows:

- The switcher sends a **Learn** command with an ID to the Media Sequencer. This means that the Media Sequencer now is ready to connect this ID to an element.
- The Multiplay operator selects an element (a preset, a video, graphics, image etc.).
- The Media Sequencer has now connected the ID to an element.
- The switcher later sends a **Recall** command with an ID to the Media Sequencer. Now the Media Sequencer is ready to perform an action on this element.
- The switcher sends a **Trigger** command with a number representing an action. The Media Sequencer performs this action on the recalled element.

6.8.2 Configuring the Media Sequencer

From the **Settings > General** tab in Viz Multiplay, click the **PBus Switcher Config** button. A new browser window opens with the configuration application.

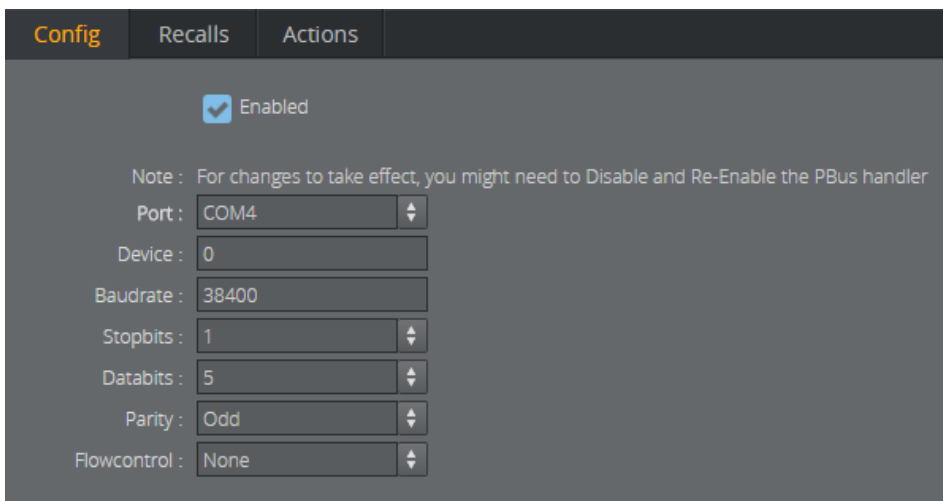

Consult the manual for the switcher to find the settings that enable communication between the switcher and MSE. The Device number must match the device number of which the switcher sends commands to, because the switcher can be connected to multiple devices. Commands can thus be sent from the switcher to one or multiple devices, by specifying the device number when sending the command.

There is no established connection between the switcher and the Media Sequencer, so it is not possible to test whether the connection is up or lost. The best way to test the connection is to send a Learn command from the switcher and monitor the result in Viz Multiplay. If a successful Learn command is sent from the switcher, a panel appears in Viz Multiplay. The following section explores this in more detail.

Note:
You may need to disable and enable the PBus settings to make them take effect in the Media Sequencer. Click the Enabled checkbox twice.

6.8.3 Learning elements

A learn panel replaces the clock when the switcher successfully sends a Learn command to the Media Sequencer. This happens for all Viz Multiplay clients connected to the Media Sequencer.

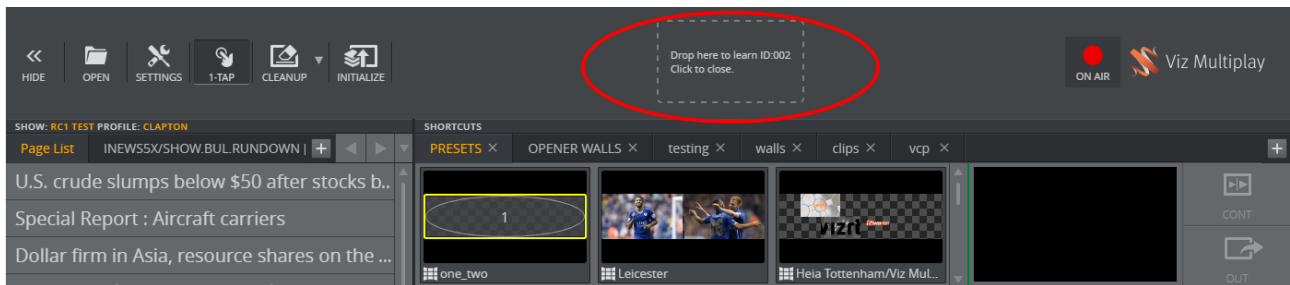

Drag any element from the Viz Multiplay GUI onto the learn panel. The panel then disappears. When this operation is done - the dropped element will be connected to the ID given from the switcher. This completes the "learn" operation. The dropped element is now "learned" by the switcher, and can later be recalled with the given ID.

Verify and monitor learned elements by opening the PBus Config application.

1. Click the **PBus Switcher Config** button in the **Settings > General** tab in Viz Multiplay.

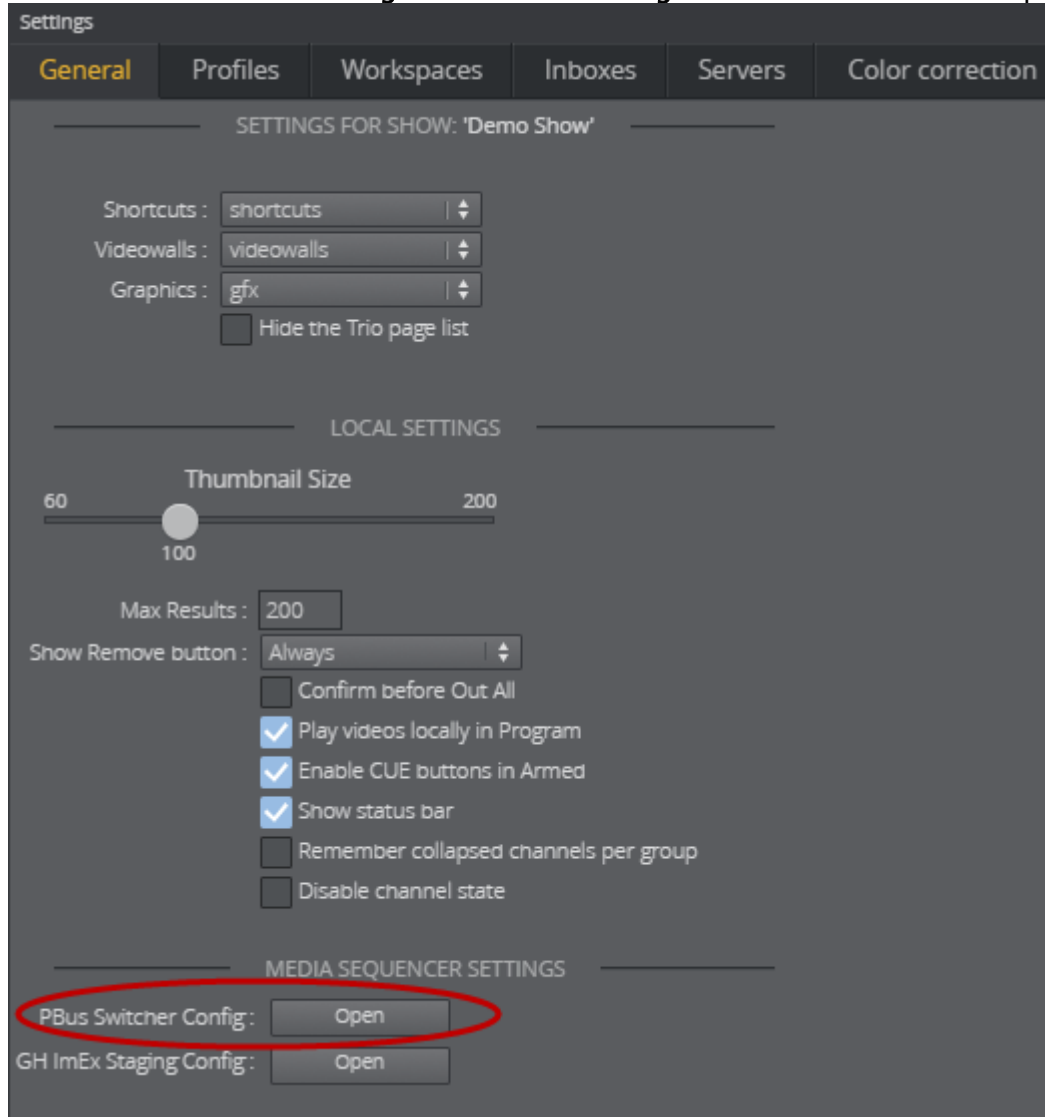

2. Click the **Recalls** tab, which contains a list of all the elements learned by the switcher.

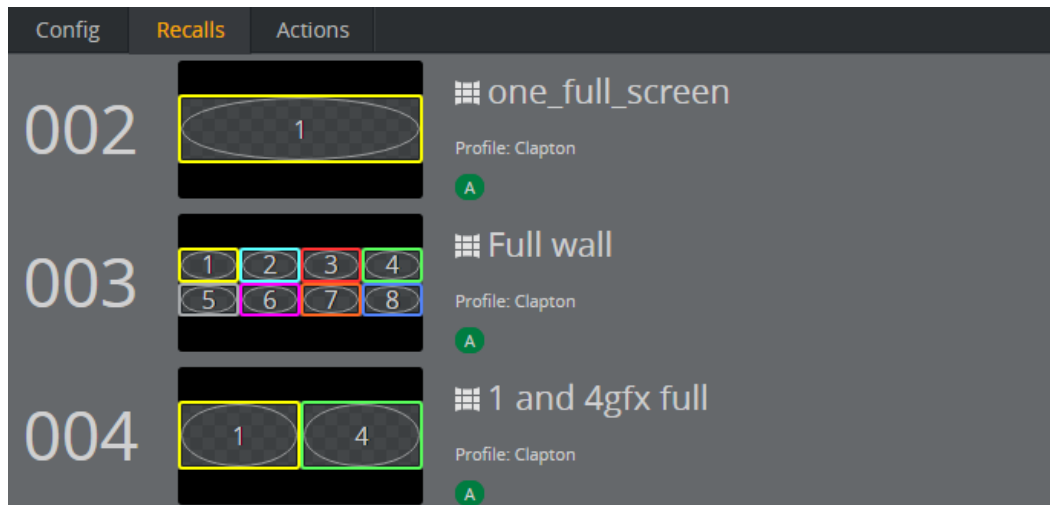

Note: Click the cross to the right in the window to remove a learned element from the list.

6.8.4 Recalling and trigger

When the switcher wants to control a learned element, it sends a Recall command with an ID. The PBus Config will then mark the recalled element.

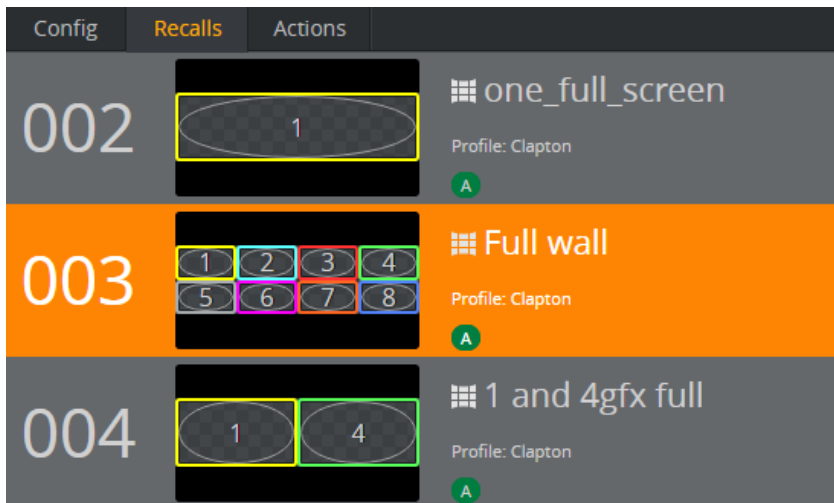

Now the recalled element is ready to receive actions. The switcher then sends a Trigger command with a number representing the action it wants to perform. The actions and their associated numbers defined default by the MSE are listed in the **Actions** tab.

Config	Recalls	Actions
ID	Action	
1	Take	
2	Continue	
3	Out	
4	Cue	
5	Pause	

**Tip:**

Configure switcher actions differently by editing the number associated with an action. For instance, the switcher sends a Trigger command with ID 0 to take an element on air, click the ID to the left of Take and change it to 0.

6.9 Using Graphic Hub Image Staging

This section covers using the Viz GH ImEx Agent, a Graphic Hub staging mechanism that automatically transfers images from URL resources to the Graphic Hub.

The agent downloads and prepares the URL resources with the suitable compression level before transferring them to the Graphic Hub. This means they use minimal resources on the renderer when taken to air, playing out without any framedrop.

This section covers:

- [Required components](#)
- [Configuration and setup](#)
- [Workflow in Viz Multiplay](#)

6.9.1 Required components

The workflow requires:

- Viz Graphic Hub
- Viz Graphic Hub REST service
- Media Sequencer version 5.0 or higher
- The [Viz GH ImEx Agent](#)

6.9.2 Configuration and setup

Install and configure ImEx over three steps by installing the ImEx Agent, creating an image staging folder and setting a publishing point.

**Info:**

This procedure requires the following components to be installed: Media Sequencer 5.0 or higher, the Graphic Hub and the Viz Graphic Hub REST service.

Install

- Install the [Viz GH ImEx Agent](#).

Create image staging folder

Create a folder in the Graphic Hub where images should be staged to. [Click here for instructions on how to create a folder in the Graphic Hub.](#)

Set publishing point

Use the Viz GH ImEx Agent to set up a publishing point to the folder through the GH REST service.

1. Enter the URL to the Viz GH ImEx Agent, then click **Options** and **GH REST Hosts**.

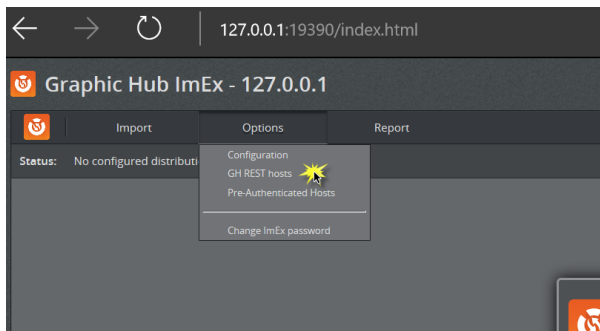

2. Click **Add GH REST Host**.
3. Select a server or enter the service document from a GH REST AGENT manually.

6.9.3 Workflow in Viz Multiplay

Enable media transfers via the ImEx Agent using the Viz Multiplay interface.

1. Click **Settings > General**, then click the **GH ImEx staging config** button.

- The configuration application opens in a new tab in the browser:

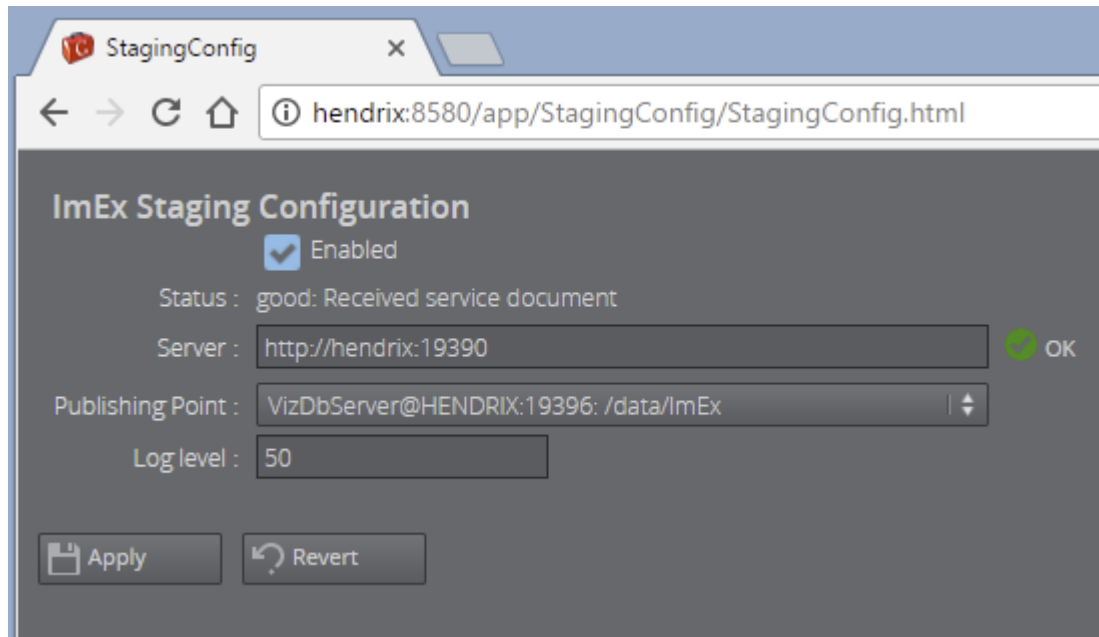

Info:
The **Server** field contains the URL to the Viz GH ImEx Agent. This service is usually found on port 19390 on the host where it is installed.

- If the connection is good, the **Publishing Point** dropdown is populated with possible Graphic Hub backends, where the images will be transferred.
- After activating a show profile, the Media Sequencer monitors images in the show and transfers from the URL source to the publishing point.
- During the publishing operation, the progress is shown on the image, as shown here:



When the image is ready, the progress disappears:



i Info:

Set the **Log level** to a value between 0 and 100 to adjust the amount of log messages from the Image Staging handler on the Media Sequencer. A higher level will generate more log messages. This can be useful when inspecting the system during debugging. The log messages appear in the Media Sequencer log.

The **Revert** button will undo any local changes in the config window. It will not reset anything on the Media Sequencer.

The **Apply** button will apply the current settings to the Media Sequencer.

6.10 Using Datapath Fx4 Display Controller

When considering how to distribute the pixels from the Viz Engine output renderer to physical devices, there are numerous solutions. The two main solutions are using nVidia Mosaic and using the Datapath Fx4 MultiDisplay Controller. This section describes the usage of the Datapath device.

Viz Multiplay integrates with the [Datapath Fx4 MultiDisplay Controller](#):



In principle - the Viz Engine draws its output on a renderer surface with a resolution covering the complete output surface. From the renderer surface, it is possible to grab pixel areas and distribute them through one or more Datapath devices to physical outputs (screens). The first step of the configuration is to set up the physical mapping from the input signal to the physical screens. This is done with the software provided by Datapath. When this is done - the Datapath configuration file can be imported into Viz Multiplay and act as a backdrop when creating presets (video wall layouts).

In this section, we will go through a typical setup covering the following:

- [Connecting the devices](#)
- [Calculating resolution](#)
- [Setting up the video wall in Multiplay](#)

The details of the Datapath setup will not be covered here. Please consult the Datapath Fx4 manual.

6.10.1 Connecting the devices

The Datapath Fx4 device accepts up to 4K input through DisplayPort. There are different ways of utilizing one or more Datapath devices together with a Viz Engine. It is recommended to have one

GPU from the nVidia Quadro series. These cards typically have 4 outputs. If the video wall needs more than a 4K resolution, two or more of the outputs from the GPU can be combined with nVidia Mosaic to create for instance an 8K surface. It is also possible to use Loop Through on the Datapath device to distribute the original signal unchanged to other outputs.

The Datapath devices can scale, duplicate or rotate any part of the input surface, so the output wall can have any aspect and resolutions. Rotation is only supported by 90 degrees.



Note:

Needless to say - larger resolutions demands more powerful hardware. Have in mind what kind of content, which formats, how many clip and live channels, and the complexity of the graphics the Viz Engine should handle when scaling the wall to large resolutions.

In our typical setup, we connected two outputs from the GPU to each of the two Datapath devices through DisplayPort. We then connected 4 HD screens to each of the Datapath boxes. To control and configure the Datapath devices, we connected the boxes with USB to a separate PC on the network. We installed the Datapath Wall Designer software on this PC. The setup looked like this:

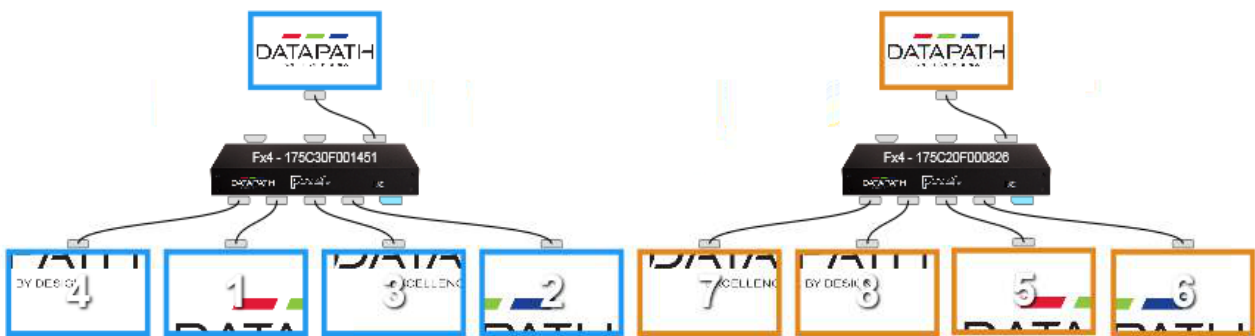

In this setup we use two 4K inputs from the GPU and distribute them to 8 screens.

An alternative approach would be to settle for less input resolution and distribute one 4K input to the 8 screens, using Loop-Through. In this way, if the output screens are HD (1920x1080), the HD screens will show scaled-up content from the 4K input. If this is an acceptable resolution on the output - it will give better performance.

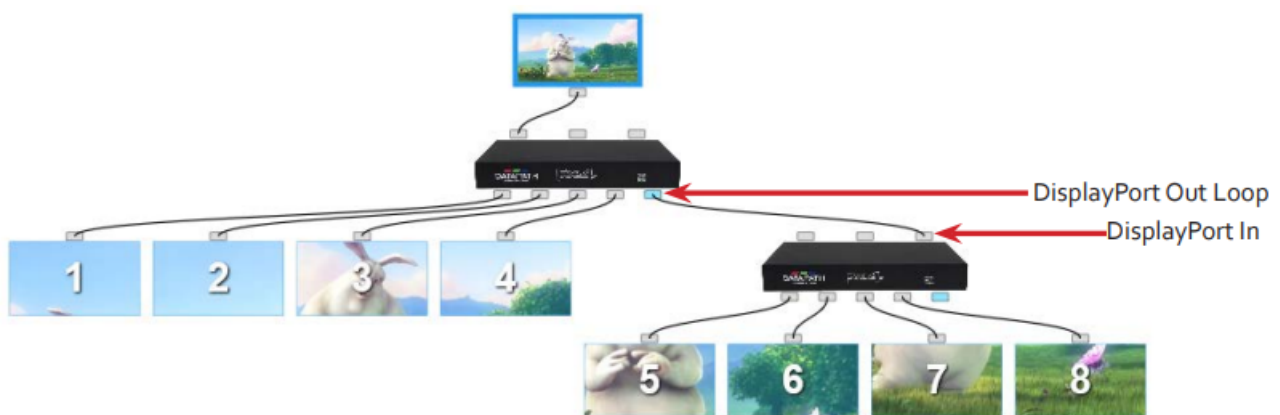

Using SYNC

To synchronize the output and input devices, it is vital to use a sync signal. The Fx4 must be genlocked to all external devices. Connect the external sync signal to each of the Datapath devices, to the nVidia GPU and the Matrox video card.

6.10.2 Calculating resolution

If your wall consists of one large surface without any bezel between screens, the input source resolution in the Datapath configuration can be set to match the wall resolution, given that the total resolution is under 4K (3840x2160). If the resolution of the wall is over 4K, and input resolutions need to be stitched together, each of the input resolutions are summed up to a total resolution, which is the resolution reported through nVidia Mosaic to the Viz Engine. This resolution can be seen in the *Output Format* section in Viz Engine Configuration.



Tip:

Even though the official limit of the **DisplayPort** input for each Datapath box is **4K/60fps** - this is a truth with modifications. The real limitation is the amount of data transmitted over the DisplayPort cable. This is limited by the DisplayPort standard "HBR2" which has a limit of 17.28 Gbit/s. This is enough for 4K/60 with 8bit per color. If the refresh rate is 50, the resolution can be slightly higher than 4K.

The bandwidth can also be affected by the cable length. Please consult the Datapath manual.

Bezels

If the screens connected to a Datapath device has a frame around the active area - the distance between the screens should be encountered in the total input resolution. The distance contains invisible pixels that will be drawn by the Viz Engine renderer, but cut away by the Datapath box. There are two ways of taking bezels into account:

1. Set the input resolution to a total of 4K or whatever the Viz Engine should output. Then, to count for the distance disappearing between the screens, calculate how many pixels are left for each screen. Example: Input resolution is 4K (3840x2160). Output screens are HD (1920x1080). Now, there aren't enough pixels in the input resolution to fill each screen with full HD *and* cover the distance between the screens. You need to calculate how many pixels you have per cm in total and reduce the capture area available for the screens. The Datapath box will scale up the content to fill the screens. This method is hard to calculate and get correctly configured.
2. The easier way: Set the input resolution to higher than the total resolution of the screens to cover for the lost pixels. Calculate how many pixels you need to add to the input resolution (horizontal and vertical) to let the screens have their content in full resolution (1920x1080 for instance), and add the amount of pixels needed to cover the gap between the screens.

In our setup, we used method number 2. We found that we had to add about 170x192 pixels to the total resolution to cover for the pixels between the screens. So the total input resolution was 4000x2352. As we run in PAL (50Hz), we still are under the maximum bandwidth of the DisplayPort capacity. In this way - the capture regions for each screen is 1920x1080, and they are placed in the corners of the total surface:

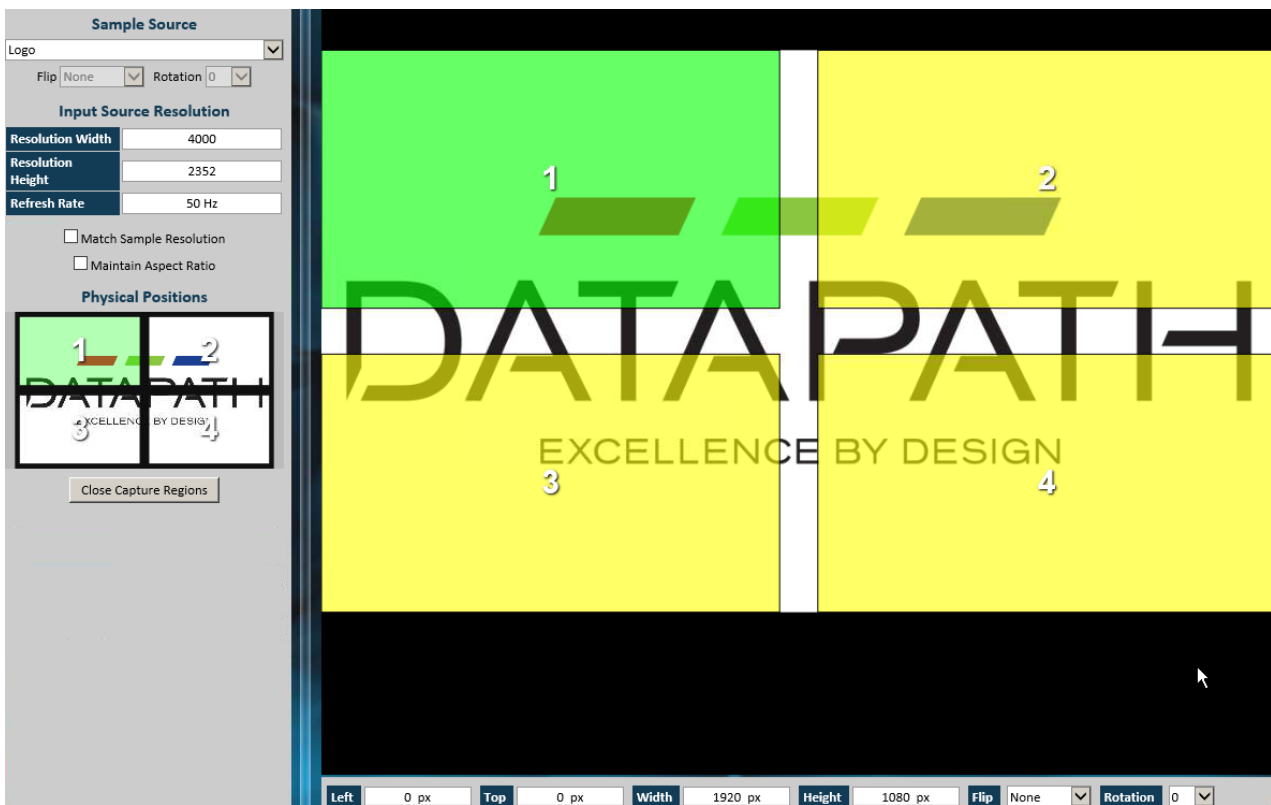

In our setup, two Datapath devices were connected to 4 screens each. The bezel internally between 2x2 screens is taken care of by the Datapath configuration, as shown above. But there is also a gap between the two blocks of 4 screens, which is outside the Datapath areas. This gap (170 pixels) was taken care of in the nVidia Mosaic configuration. The total resolution for the renderer then became 8170x2352.

6.10.3 Setting up the video wall in Multiplay

In Multiplay, the goal is now to use the Datapath configuration as a backdrop for editing the GFX channel layouts (presets).

Create the video wall

First of all, when creating a new video wall in a profile, we now know that the physical layout of the wall should be determined by the Datapath configuration, and not rows and columns in a nVidia Mosaic setup. We therefore specify that our wall consists of one, big surface (1 row and 1 column) and specify the screen size to match the total resolution of the Viz Engine renderer. In our typical setup, 2 x 4K plus bezel between the screens ended up in a resolution of 8170x2352.

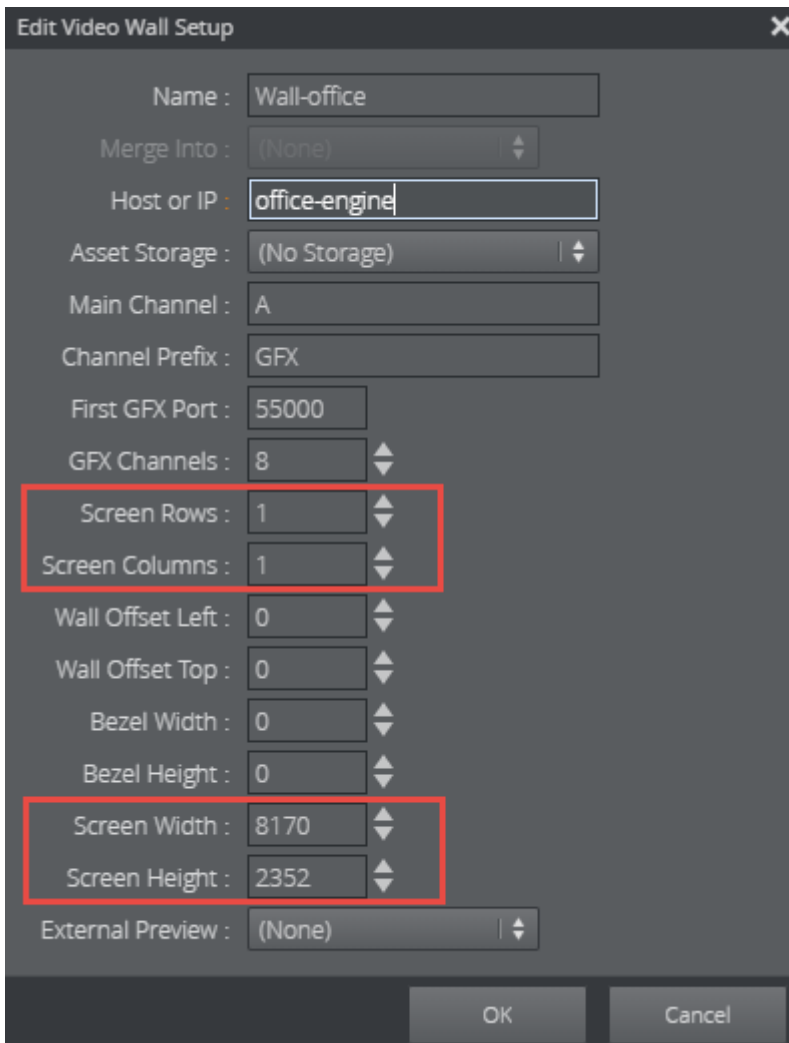

Video Wall Designer

In the Video Wall designer, it is possible to create and edit the Active Areas, which will become snap points for the GFX layout (the presets). But since the visual configuration already is done in the Datapath Wall Designer, we can import this configuration into Multiplay. In Datapath Wall Designer, you need to save the configuration. This becomes a *.wdl file, which consists of an XML structure describing the Datapath setup (inputs and capture areas). If you have more than one Datapath box connected to the computer running the Wall Designer, or on the network, the wdl file contains the combined configuration.

- In the Video Wall designer, click the Active Areas Editor button:



In the Active Areas editor mode, the GFX channels are hidden, and only the backdrop is visible. For now, the backdrop is one, empty area.

- Now you can import the wdl file by clicking the Import button:

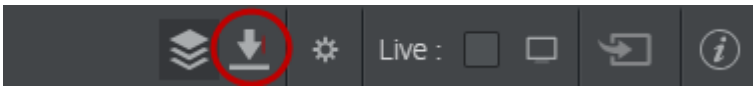

A dialog box then opens. Either click the area in the middle or drag the wdl file into this area. The PC you're running Multiplay on needs to have access to this file, either from a shared disk - or you can copy the file from the Datapath Wall Designer PC to the Multiplay PC first. When the file is read - a green status message will display the file name and a "Done!" message. Under this message, the number of Datapath wall regions (capture areas) is displayed.

- Click Add to generate the Active Areas in the Video Wall designer.

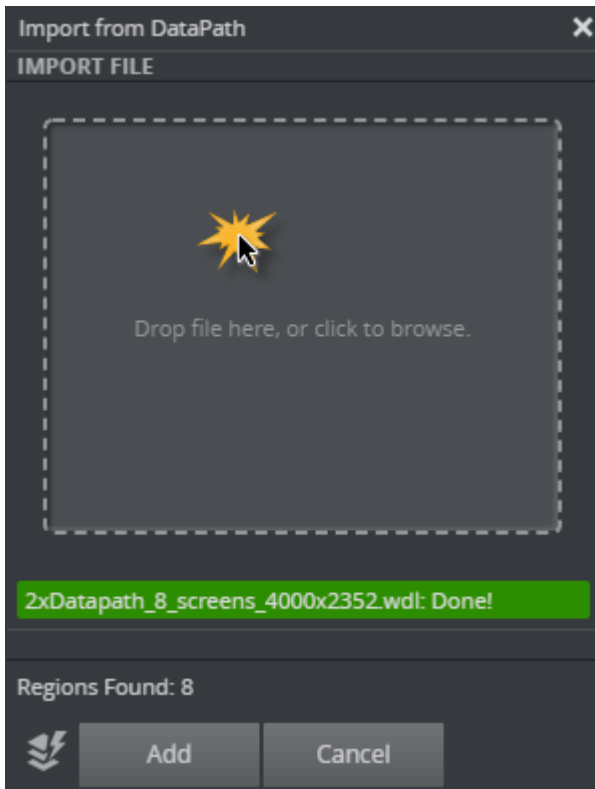

The next time this operation is done - it is possible to clear the existing Active Areas first, by clicking the following toggle button:

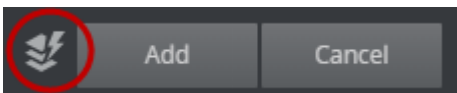

After importing and possibly editing the Active Areas from the Datapath configuration, the Video Wall designer may look like this:

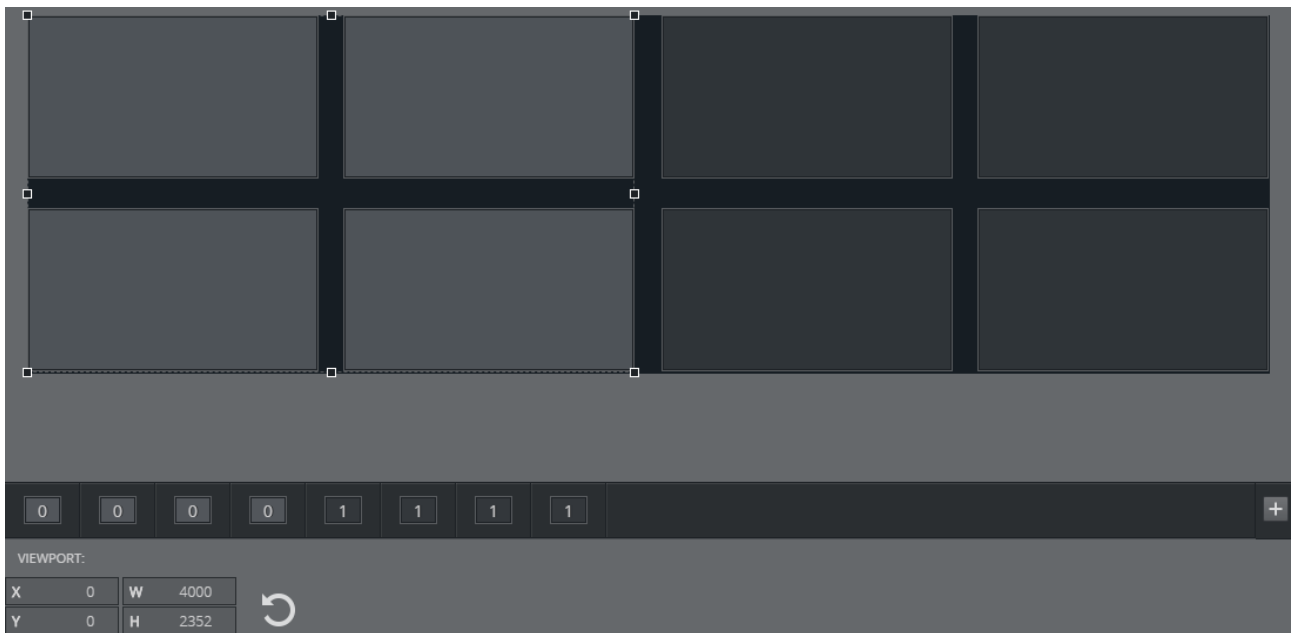

In this case, we have imported 8 regions from 2 Datapath boxes. Each of the Datapath devices is represented as a group of Active Areas. The numbers below the editor (0 and 1) indicate which group each area belongs to.

- Clicking once on an Active Area will select this area individually.
- Clicking the next time will select the group this area belongs to.



Tip:

When importing a Datapath configuration containing more than one Datapath device, the groups will initially be placed on top of each other in the editor. The Datapath configuration contains no info on where the outputs of the devices are located relative to each other. In our typical setup, both groups of 4 screens ended up on the left side of the editor. The second group then had to be dragged to the right side of the video wall representation in the editor. In this case, it is useful to enable the "Live" function and the "Fill color" function to ensure that the Active Areas actually match the monitors in the video wall.

7 Troubleshooting And Common Issues

This section lists tips for troubleshooting and issues that can be useful for the users of the Viz Multiplay application. Also, see the Related Documents for help with other Vizrt products.

**Note:**

To view log messages and version information, go to the [Status Bar](#).

This section contains:

- [Troubleshooting](#)
 - [Known Issues](#)
 - [Tricks and Hints](#)
 - [Frequently Asked Questions](#)
-

7.1 Troubleshooting

- [The Viz Engine output keeps going black randomly](#)
- [When I run Viz Engine in fullscreen my graphic quality downgrades to SD](#)
- [Video transfer from a search result to a GFX channel stays on 0%](#)
- [Video transfer from a search result gives errors](#)
- [The search panel looks disabled and it returns an error about Viz One](#)
- [My clips/graphics do not appear on the output engines when I put them on air](#)
- [No thumbnails for my graphics appear in Viz Multiplay](#)
- [The show opens but doesn't display any stories or content](#)
- [I have set up profiles but get an error about No Viz/video program](#)
- [Problems running Preview Server](#)

7.1.1 The Viz Engine output keeps going black randomly

If you are using your Viz Engine as a preview server you may see this behavior. Use another Viz Engine to serve out thumbnails.

7.1.2 When I run Viz Engine in fullscreen my graphic quality downgrades to SD

This typically happens when using multiple screens. Verify that *Video wall/Multi display* is set correctly in your Viz Engine.

Go to Viz Configuration > Video Output > Video wall/Multi display, and set this to "active".

7.1.3 Video transfer from a search result to a GFX channel stays on 0%

This can happen if Media Sequencer hasn't grabbed the information for asset storage(s).

To resolve this either:

- In Viz Multiplay, go to Settings > General > Active Profile, and set it to *No Profile*, and then back to the one you were using. This will reinitiate all transfers. Or,
- In Viz Trio, set the pagelist to *inactive*, and then *active* again, which reinitiates all transfers. Then in Viz Trio, confirm that videos can be searched for, added to the playlist and played out.

7.1.4 Video transfer from a search result gives errors

ARDFTP and 'No destination available' errors can occur when there is an error with the publishing point in Viz One. Verify that your Viz One can FTP into your Viz Engine.

7.1.5 The search panel looks disabled and it returns an error about Viz One

Viz Multiplay can't access Viz One. This could be because there is no network connection to the Viz One, or because there is incorrect host or login information.

In Viz Trio, verify the Viz One configuration by going to "Search Media" and performing a search. In Viz Multiplay, when you get the Viz One popup, use the same credentials as you used in Viz Trio.

7.1.6 My clips/graphics do not appear on the output engines when I put them on air

Always double check that the elements can be played out from Viz Trio. Also, run the Media Sequencer in a console (not as a service) to get more information on what's wrong when taking elements on air. The messages in the Media Sequencer console are often very useful.

7.1.7 No thumbnails for my graphics appear in Viz Multiplay

The Media Sequencer produces the thumbnail URLs for the elements, so it needs to have a Preview Server configured:

1. Go to Settings > Servers in Viz Multiplay, and verify that a preview server host is set.
2. When Viz Multiplay is loading, inspect the network traffic in the browser and look for the requests to the Preview Server. Check the HTTP response, which contains an error message.

7.1.8 The show opens but doesn't display any stories or content

If a Viz Trio show contains elements which are not within a group, then they will not be visible in Viz Multiplay. The show may appear empty in Viz Multiplay, even though the Viz Trio show contains elements.

Create a group in the show and move elements into the group.

7.1.9 I have set up profiles but get an error about No Viz/video program

The error may look like *“No Viz/video program for this entry. Please check the Viz/video program output configuration”*.

This means that an element has been added to a channel that does not support it (eg. adding video to a graphics channel or vice versa). This can also occur if a profile is selected which does not have a program channel. Also try to deactivate the profile and reactivate it again.

7.1.10 Problems running Preview Server

To troubleshoot the Preview Server, go to the debug page for the Media Sequencer on http://mse_host:8580/debug and browse to your show elements. Do you see thumbnails on this page? If not, click on the thumbnail and you will get an error message. You can also inspect the network traffic in the browser (in Chrome and Firefox by pressing **F12** and going to ‘Network’) when loading the show in Viz Multiplay. Inspect the HTTP response of the broken Preview Server requests. This should give you a hint as to where the problem lies.

7.2 Known Issues

Known issues in Viz Multiplay:

- Thumbnails for graphics with video texture will only display the graphic.
 - Running Cleanup also cleans up the Presets scene. Therefore, after a cleanup, you must run a Preset before running other elements. To do this, click on a Preset.
 - Do not initialize while one air, as this can result in a lag in the graphics output.
 - If a playlist is activated by a Viz Trio client, then it will be deactivated if that Viz Trio client shuts down, and Viz Multiplay will lose its active profile. Always set the Active Profile for a playlist in Viz Multiplay.
 - Viz Multiplay does not support videos with overlay graphics as a timeline. To display graphics on top of videos, place GFX channels on top of each other and play elements manually in each channel.
 - Using color correction together with a bezel in the NVIDIA Mosaic setup will require Viz Engine 3.8.3.
-

7.3 Tricks And Hints

- [Filling clips/images in GFX channels instead of letterboxing](#)
- [Enabling transitions between video clips](#)
- [Tricks and Hints for Viz Engine 3.8.2 or later](#)
- [Tricks and Hints for NVIDIA Mosaic](#)
- [Performance Issues](#)

7.3.1 Filling clips/images in GFX channels instead of letterboxing

In GFX channels, the StillAndVideo scene will letterbox clips and images. If for instance a 16:9 clip or image is played out in a portrait GFX channel, the content will not be cut off, but placed inside the portrait area to fill the width but not the height. The GFX channel will be blank over and under the content. If you want to fill the whole GFX area always - scale up the content and cut it off - this can currently be done by manipulating the **StillAndVideoScene** like this:

Do one change in these 4 scripts:

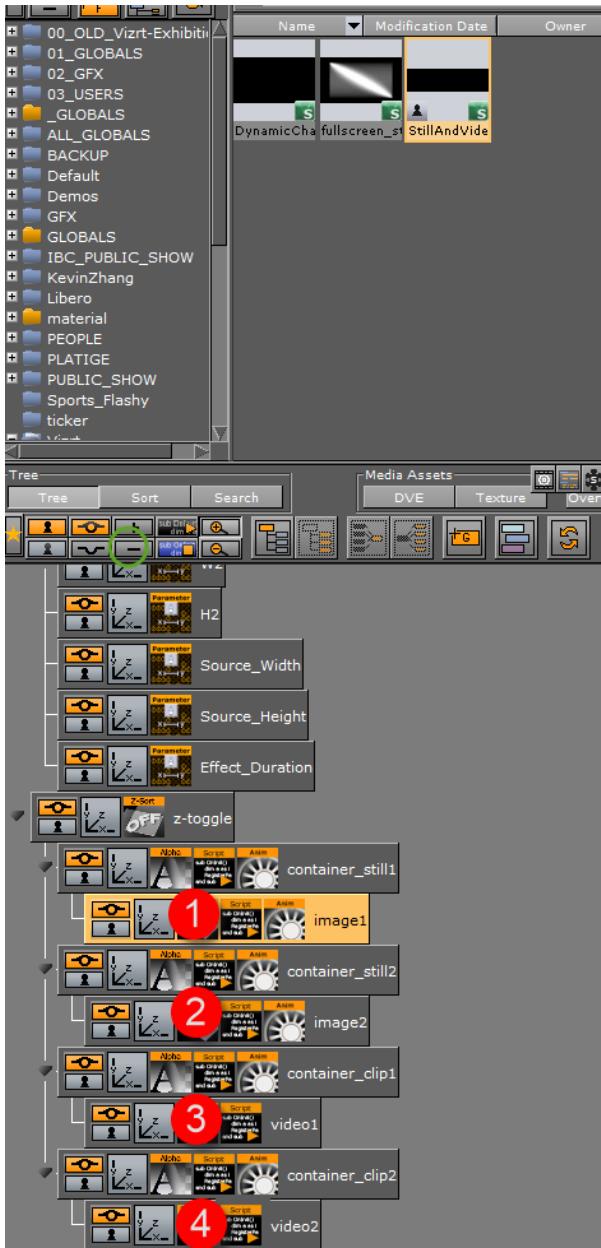

The script lines are:

- if render_aspect>(my_aspect*kb_aspect) then for image1 and image2
- if render_aspect>(image_aspect) then for video1 and video2

In these four script lines, change > (greater than) to < (less than). Click Compile and run for each script you open. Save the scene. Cleanup the renderer and take a preset again. Now the letterboxing should be changed to a fill.

7.3.2 Enabling transitions between video clips

The Viz Engine has 16 GFX channels and 16 video clip channels. In Viz Multiplay one clip channel is used per GFX channel. This means that 16 clips can be played simultaneously in 16 different GFX channels. Though, if fading between clips should be enabled, each GFX channel then needs two clip channels to perform the fading. This means that for each GFX channel that should have transition enabled, the number of GFX channels should be reduced with 1.

Example 1: 2 GFX channels with transitions enabled. In this scenario, clips with transitions should always be played in two special GFX channels - for instance, GFX1 and GFX2. These two GFX channels then need two extra clip channels to perform the fade. Using clip channels 15 and 16 for this - will then effectively mean that the video wall setup will only have 14 GFX channels available.

Example 2: 8 GFX channels with transitions enabled. In this scenario - all available GFX channels will have the possibility to play transitions between clips. This reduces the number of GFX channels to 8. GFX1 may use clip channel 9 for the transitions, GFX2 may use clip channel 10 and so one.

Setup clip transitions

- In Viz Artist, open the Vizrt\DynamicChannels scene.
- Go to **Media Assets > Texture** and add (drag in) as many extra clip channels as needed (8 is added by default):

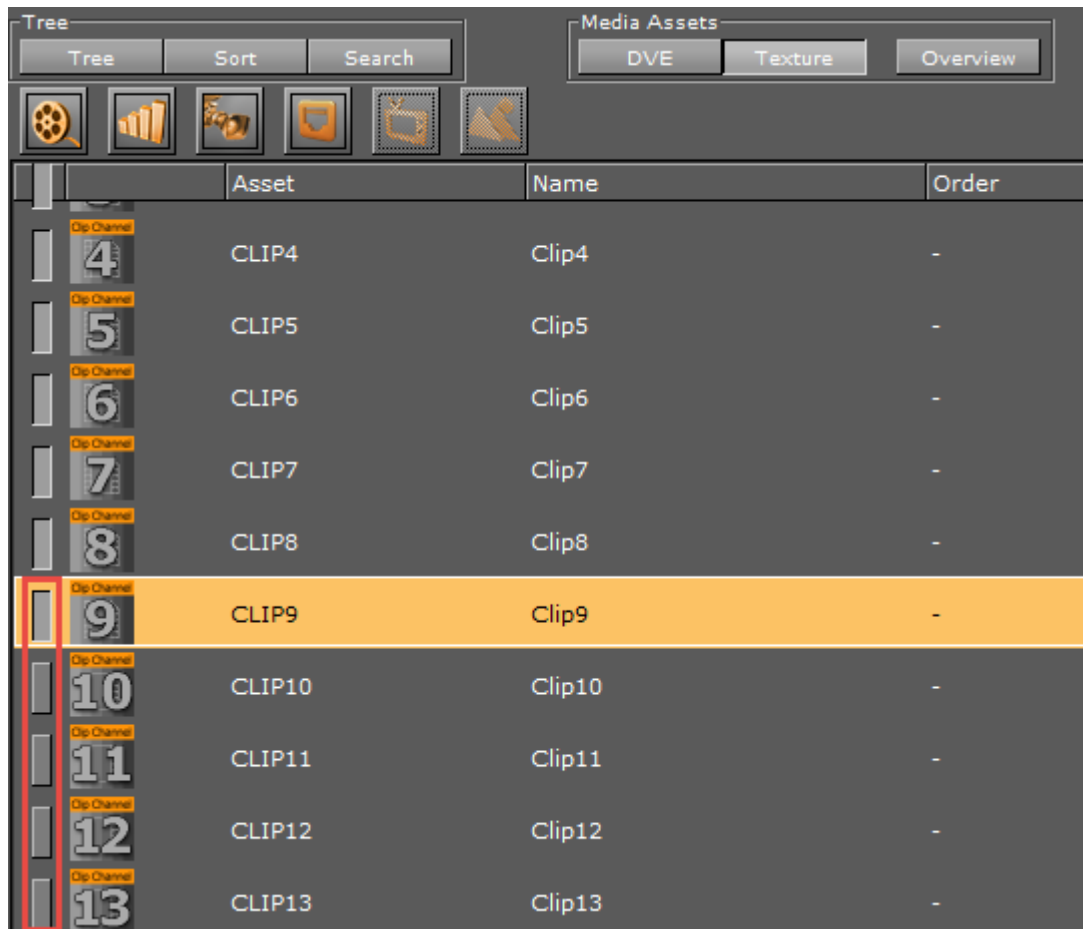

- If more than 8 GFX channels are needed, go to **Media Assets > DVE** and enable as many GFX channels as needed.
- In Multiplay, go to **Settings > Profile Config**.
- Click the profile for the video wall and expand the GFX channels that should have clip transitions.
- Double-click the video handler under each GFX channel:

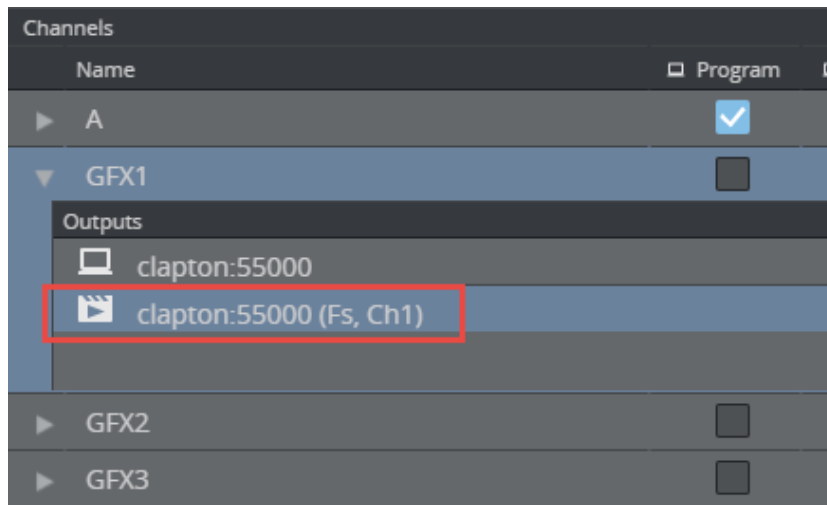

- Check **Use Transitions** and enter the alternate clip channel number to use. Usually, each GFX channel uses the corresponding clip channel number, but now, the clip channel number entered in **Alternate Clip Channel** will prevent the corresponding GFX channel to be used. In the example below, clip channel 9 is used for the fade, which means that GFX 9 is unavailable for clips.

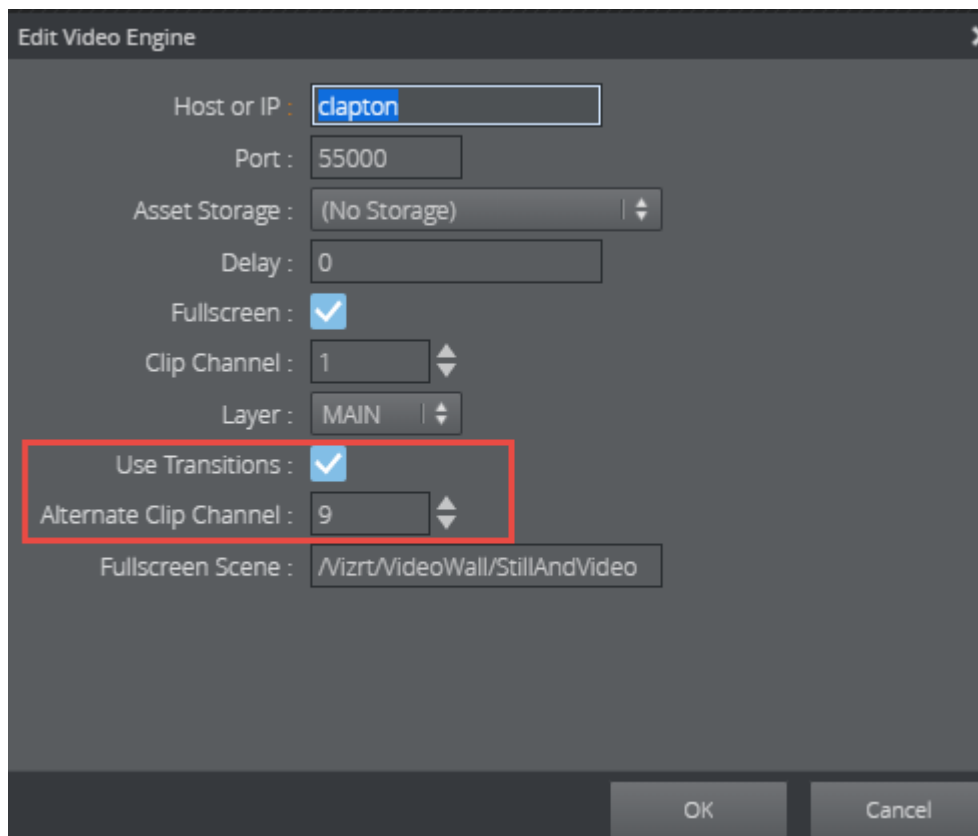

7.3.3 Tricks and Hints for Viz Engine 3.8.2 or later

Make sure you read and follow the recommendations in the *Video Wall Configuration* section of the [Viz Engine Administrator Guide](#).

- To get better performance, start viz.exe with parameter -w. In addition, set the setting create_default_renderer = 1 in the config file.
- To see commands: "send MAIN SHOW_COMMANDS ON".
- If more than one GPU is used, and video clips and transitions flicker, send the command "RENDERER JOIN_SWAPGROUP 1".
- Remember that playing clips requires that all that frame rates and refresh rates match the videos - both in Clip in formats, renderer format and on the actual physical screens.
- To see performance, send the command "RENDERER SET_PERFORMANCE 1".

7.3.4 Tricks and Hints for NVIDIA Mosaic

Common Requirements

- All monitors connected to the GPU must be identical models and running at identical resolutions/refresh rates. You can not have a different resolution/model 'control' monitor connected to the system without introducing tearing in at least one of the displays.
- If possible, the monitors should be combined into a single large virtual monitor using Nvidia's Mosaic.
- Only have one window rendering. If you are outputting to multiple monitors use a single large window that covers your entire desktop, not one window per monitor.

Quadros

- When setting up Mosaic, be sure to not move monitors around using this dialog. Due to a driver bug this will disable the Preset you are trying to use in the next step. If your monitors are connected in reverse, change the connections manually.
- In the Nvidia Control Panel, go to the "Manage 3D settings" page and select "Video Editing" as the profile/preset to be used.
- Ensure the Windows taskbar is not on top of your display window.
We have tested our system with an external blackburst sync signal, if you try to use anything else than NTSC or PAL as sync format the screen will start to flicker.

For normal 50 Hz European format use PAL.

7.3.5 Performance Issues

This section covers the following topics:

- DynamicChannel scene
- Video wall setup
- Background loading of images (performance)

DynamicChannel scene

The DynamicChannel scene must be seen as a template. It should not be used in the distributed version. It must be modified by a Viz Artist expert on location to match the customer system.

This will improve performance significantly:

- In DynamicChannel, disable or preferably remove all GFX channels not in use. (The default DynamicChannels scene has 16 GFX channels, of which 8 are disabled.)

In addition, during the playout situation:

Before going on air, "warm up" (take) all the scenes that are going to be taken. Initializing is often not enough. Scenes should be taken on air and out again at least once on their GFX channel. The next time they are taken, Viz Engine displays them without affecting the overall performance.

Always take a preset on air before the show starts. Never take presets out. There should always be a preset on air.

Video wall setup

Configuring a video wall setup is not straight forward. Make sure you read and follow [this advice](#).



Tip:

There are many factors impacting the performance of a video wall driven by one Viz Engine, so try experimenting and fine tune the setup with real content and real constraints.

Background loading of images (performance)

Support for background loading of images was added in Multiplay 2.2.



Note:

This is unrelated to the general config setting enabling background loading in Viz Config.

This fixes a bug that froze the video wall for notable periods. This arose when a fullscreen image was added to a show and taken to air without initializing it first. While downloading the image, the Viz Engine would then block the renderer and render the image, causing the wall to freeze.

Requirements

- Background loading of images requires the latest official Viz 3.8.3.62368 build (or later) on the official [FTP](#).
- The #13 version (the scene version bundled with Multiplay 2.2) of the DynamicChannels scene must be present in Graphic Hub.



Note:

Images from an HTTP resource (Viz One and Media Service) can still cause a small frame drop in the renderer, but at least the renderer will download it in the background and not block for a long period.

Preparation of images in GH

Images from Graphic Hub should not cause any frame drop in the renderer if they are background-loading compatible. This means they should be DXT1 or DXT5 compressed images.

To check whether a GH image is background loading compatible:

1. Open Viz Artist, locate it in the server tree.
 2. Right-click the image and choose **Check for Background Loading**.
To make a GH image background loading compatible:
 1. Open Viz Artist, locate it in the server tree.
 2. Open the image by double-clicking it.
 3. Choose **Convert Format** in the left menu.
 4. Choose **DXT1** or **DXT5** in the menu that appears.
 5. Save it.
-

7.4 Frequently Asked Questions

- [How do I set up a video wall with screens with different aspects and resolutions?](#)
- [Does Viz Multiplay support clips with non broadcast format?](#)
- [Can I use Viz Pilot instead of Viz Trio?](#)
- [What is the technical limitation of playing HD clips?](#)
- [Does the playlist update after changes in the newsroom system rundown?](#)
- [Can Viz Multiplay play out graphics created via Viz Pilot templates?](#)
- [Can Viz Multiplay open a playlist from Viz Pilot?](#)
- [Can Viz Multiplay open a MOS rundown? What is the workflow?](#)
- [How do I run movie clips?](#)
- [Can we have live input in one of the monitors or across a group?](#)
- [Can I use a touch screen monitor in my live-to-air control room?](#)
- [Can Viz Multiplay be controlled by Viz Mosart, VDCP, Viz Trio or Viz Pilot?](#)
- [Can Viz Multiplay be integrated into a Mosart workflow?](#)
- [Can we use Social TV as a source for Viz Multiplay?](#)
- [Do I need a Viz One to feed Viz Multiplay with clips and images?](#)

7.4.1 How do I set up a video wall with screens with different aspects and resolutions?

The easiest way is to use an external video wall display controller like Datapath Fx4. These controllers accept up to 4K input and 4 outputs. With Nvidia Mosaic up to 4 outputs from the GPU can be combined and split up with Datapath Fx4 display controllers.

7.4.2 Does Viz Multiplay support clips with non broadcast format?

Videos in Viz Multiplay are limited to the broadcast formats and aspects supported by the clip channels in Viz Engine.

Can I assign GFX channels to different aspects?

If a GFX channel is only used to play out elements with a special aspect - like portrait images, it is possible to set the aspect for this channel. Then thumbnails and GFX channels in the Video Wall designer will respect this aspect. This will not affect playout in any way - only how the elements are displayed in the Multiplay GUI.

Do I need Viz Trio or Viz Pilot to set up Viz Multiplay?

If you are using Viz Multiplay for clips and images only, you can do without.

However Viz Trio or Viz Pilot *is* required if you need to import and play out graphics from a Viz Engine.

7.4.3 Can I use Viz Pilot instead of Viz Trio?

Yes!

7.4.4 What is the technical limitation of playing HD clips?

The technical limitation of the number of channels is 16, depending on the video board. The performance when playing a number of clips is dependent of lot of different factors, like the hardware and the clip codecs and formats. Real life tests should always be conducted before going into production.

7.4.5 Does the playlist update after changes in the newsroom system rundown?

Yes. It is the Media Sequencer that communicates through the MOS protocol with the newsroom system (ENPS, iNews etc.). Any update is handled by the Media Sequencer, and the playlist in Viz Multiplay will automatically display the changes.

7.4.6 Can Viz Multiplay play out graphics created via Viz Pilot templates?

Yes. Create a Viz Pilot rundown with the graphics, images and videos you want to play out. The playlist will automatically be available in Viz Multiplay.

7.4.7 Can Viz Multiplay open a playlist from Viz Pilot?

Yes. Add the playlist to the show with the Add button on the Show pane. Once open in Viz Multiplay, the playlist updates dynamically, as it is changed in Viz Pilot.

Click the **Add (+)** button in the [Show Pane](#) to open an existing external playlist.

7.4.8 Can Viz Multiplay open a MOS rundown? What is the workflow?

Yes, you can add any external playlist to the show - so both the show and the added playlist(s) are available in Viz Multiplay. In this way the user can, for example, have a show with video wall presets and other more permanent elements, and add a MOS rundown or a Viz Pilot rundown to this show to make the MOS/Viz Pilot elements available too.

7.4.9 How do I run movie clips?

Simply click or tap them and they will either be armed or played directly on air.

7.4.10 Can we have live input in one of the monitors or across a group?

Yes. Custom scenes with a live input source must be created in Viz Artist and imported by Viz Trio as regular pages. These pages can be placed in the inbox show and then dragged into any channel.

7.4.11 Can I use a touch screen monitor in my live-to-air control room?

Viz Multiplay can easily be operated for playout on touch devices, but it is not advisable to do editing on them. We have found Firefox to have the best touch screen experience when using Viz Multiplay.

7.4.12 Can Viz Multiplay be controlled by Viz Mosart, VDCP, Viz Trio or Viz Pilot?

Not really. The Media Sequencer does not support detecting the last taken element per channel. This means that even though a playlist can be controlled by external triggering or a control client, Viz Multiplay will not detect elements taken on air, and the elements will not show up in the Program or Armed column.

7.4.13 Can Viz Multiplay be integrated into a Mosart workflow?

Ye. It requires some manual steps. Basically it is possible to create video wall presets in Multiplay and play them out as Pilot elements in a Mosart rundown. Contact Vizrt Support for more information.

7.4.14 Can we use Social TV as a source for Viz Multiplay?

Yes. Social TV creates regular Viz Trio pages in a show that can be opened or used as an inbox in Viz Multiplay, so the elements can be controlled by Viz Multiplay.

7.4.15 Do I need a Viz One to feed Viz Multiplay with clips and images?

We do recommend having a Viz One or a Media Service installed and configured on the Media Sequencer. It is also possible to use a Graphic Hub REST service as a source for images.