



Viz Engine Administrator Guide

Version 3.13



Viz Engine



Copyright © 2019 Vizrt. All rights reserved.

No part of this software, documentation or publication may be reproduced, transcribed, stored in a retrieval system, translated into any language, computer language, or transmitted in any form or by any means, electronically, mechanically, magnetically, optically, chemically, photocopied, manually, or otherwise, without prior written permission from Vizrt. Vizrt specifically retains title to all Vizrt software. This software is supplied under a license agreement and may only be installed, used or copied in accordance to that agreement.

Disclaimer

Vizrt provides this publication “as is” without warranty of any kind, either expressed or implied. This publication may contain technical inaccuracies or typographical errors. While every precaution has been taken in the preparation of this document to ensure that it contains accurate and up-to-date information, the publisher and author assume no responsibility for errors or omissions. Nor is any liability assumed for damages resulting from the use of the information contained in this document. Vizrt’s policy is one of continual development, so the content of this document is periodically subject to be modified without notice. These changes will be incorporated in new editions of the publication. Vizrt may make improvements and/or changes in the product (s) and/or the program(s) described in this publication at any time. Vizrt may have patents or pending patent applications covering subject matters in this document. The furnishing of this document does not give you any license to these patents.

Technical Support

For technical support and the latest news of upgrades, documentation, and related products, visit the Vizrt web site at www.vizrt.com.

Created on

2019/03/28

Contents

1	New in Viz Engine 3.13	14
1.1	NMOS IS-04 Support for SMPTE ST-2110 Infrastructure.....	14
1.2	NDI support using Matrox.....	14
2	Introduction.....	15
2.1	Related Documents.....	15
2.2	Feedback and Suggestions.....	15
3	New WIBU based Licensing System	16
3.1	Important Pre-installation Information.....	17
3.2	Key Features and Workflow of the New Licensing System	17
3.3	Limitations and Known Issues	17
3.4	Basic Set-up	18
3.5	Configuration Settings	19
3.5.1	Why Do We Need to Configure the Licenses?.....	19
3.5.2	Configuring the License System in the Viz Engine Configuration UI	19
3.5.3	Monitor the License System in the Viz Engine Configuration UI	20
3.5.4	Configuration Entries in the Viz Engine Configuration File.....	20
3.6	WIBU License System.....	22
3.6.1	Introduction.....	22
3.6.2	WIBU License Share Status.....	23
3.6.3	WIBU Core License Summary	23
3.6.4	WIBU Licenses and Their Effect.....	26
3.7	Notes.....	34
3.7.1	Starting Viz Engine with WIBU License System	34
3.7.2	Starting Viz Engine with DVI OUT	35
3.7.3	Starting Viz Engine with MezzIP OUT and/or 1xMezzIP IN	35
3.7.4	Starting Viz Engine with Frameserver Functionality (MUX Ports).....	37
3.7.5	Starting Viz Engine with SDI/IP OUT or SDI/IP IN	37
3.7.6	Starting Viz Engine with Artist.....	37
3.7.7	Starting Viz Engine with Transition License - WIBU license bound to VALID/Sentinel dongle ID.....	37
3.8	Setup Redundancy for a WIBU License Server.....	38
3.8.1	Steps to Setup Redundancy for a WIBU License Server	38
3.8.2	Test License Server Failover	38
3.8.3	Recover First License Server	38
3.8.4	Notes.....	34

4	Software Configuration	40
4.1	Prerequisites.....	40
4.1.1	Supported Operating Systems.....	40
4.1.2	Virtual Environments.....	42
4.1.3	Environmental settings	42
4.1.4	Hardware and BIOS settings	43
4.1.5	Power Management Settings	43
4.1.6	User Rights	43
4.1.7	Secure Boot.....	43
4.1.8	Running Viz Engine and Viz Artist without Administrator Rights	44
4.1.9	Anti-Virus Software	44
4.2	Viz Artist and Engine Folders	44
4.2.1	Installation Folders	44
4.2.2	Data Folders	45
4.3	Supported Software	45
4.3.1	Viz Engine Software	45
4.3.2	Preview Server	46
4.3.3	Viz Artist Software	47
4.4	Ports and Connections	47
4.4.1	Port Numbers	47
4.4.2	Multiplexing Ports.....	52
4.5	User Account Control.....	53
4.6	Viz Artist and Engine Installation	54
4.6.1	Installing Viz Artist and Engine	54
4.6.2	Upgrading from a Previous Installation.....	56
4.6.3	To Change or Reinstall an Existing Installation.....	57
4.6.4	Silent Installation of Viz Artist and Engine.....	57
4.6.5	To Identify Installed Architecture and Version	58
4.7	Viz Artist and Engine Platforms	59
4.8	Install the Legacy Hardlock Based Viz License	60
4.8.1	To Apply a Viz License in the GUI.....	60
4.8.2	To Apply a Viz License in Viz Configuration	61
4.8.3	To Apply a Viz License with the Viz Console	62
4.9	EVS Video Server Control	62
4.9.1	Setup Requirements.....	63
4.9.2	RS422 and XtenDD35 Configuration	63
4.9.3	RS422 Pin-out for the Connector Cable	63

4.9.4	RS422 Controller Set Up Examples	64
4.9.5	Bluestorm LP PCI card configuration.....	64
4.9.6	ExSys EX-1303 USB to RS422 Connector Configuration.....	64
4.10	Dual Channel Mode.....	64
4.10.1	To Configure Dual Channel.....	65
4.11	Trio Box CG Mode.....	65
4.11.1	To Configure Trio Box CG	66
4.12	Integration with Viz One	66
4.12.1	Configure Viz Engine	67
4.12.2	Install Transfer and Monitor Services on Viz Engine	67
4.12.3	Configure Local Preview of Video Files	69
4.13	Viz Engine REST interface.....	71
4.14	Dolby E Support	72
4.14.1	Dolby E Features.....	72
4.14.2	Dolby E Configuration.....	73
4.15	Newtek NDI.....	74
4.15.1	Newtek Only	74
4.15.2	NDI in Combination with Matrox	75
5	Hardware Related Information.....	76
5.1	Handling and Installing Cards	76
5.2	Graphics Boards.....	76
5.2.1	NVIDIA Driver Configuration	77
5.2.2	Supported GPUs and Driver History	82
5.2.3	Working with Two or More GPUs	84
5.2.4	Working with Synchronous Output.....	84
5.3	Supported Systems	87
5.3.1	HP Z8 G4	87
5.3.2	HP Z4 G4	91
5.3.3	HP Z840.....	94
5.3.4	HP Z820.....	96
5.3.5	HP Z800.....	99
5.3.6	HP Z440.....	102
5.3.7	HP Z400/Z420	104
5.3.8	HP ZBook 17 G5.....	106
5.3.9	Dell Precision R3930.....	106
5.3.10	HP DL380 Gen9	109
5.3.11	HP DL360 Gen9	110

5.3.12	HP ZBook G3 Mobile Workstation	112
5.3.13	Dell R7920.....	113
5.3.14	Dell R7910 2U Rack Server.....	115
5.4	Video Boards	116
5.4.1	Matrox Hardware	117
5.4.2	BlueFish444	166
5.4.3	AJA Hardware.....	174
5.5	Legacy Information	178
5.5.1	Deprecated systems.....	178
5.5.2	Deprecated Video Boards	202
5.5.3	Legacy Graphic Boards.....	230
6	Starting Viz Engine	238
6.1	To Start Viz Engine	238
6.2	To Add a Viz Engine Startup Option	238
6.2.1	Viz Configuration.....	238
6.3	Viz Console	239
6.3.1	Issuing External Commands to Viz Engine via Console.....	239
6.3.2	Internal Commands	241
6.4	Viz Command Line Options.....	242
6.4.1	Systems with Two or More GPUs	244
7	Configuring Viz	245
7.1	Working with Viz Configuration	245
7.1.1	To Start Viz Configuration.....	245
7.2	Modify Viz Configuration	246
7.2.1	To Save the Current Configuration	246
7.2.2	To Reset the Viz Config File	246
7.2.3	To Restart Viz Configuration.....	246
7.3	Installed Configuration Profiles	246
7.3.1	To Load a Pre-Installed Configuration Profile.....	247
7.3.2	To Save a Custom Profile	247
7.3.3	To Load a Custom Configuration Profile.....	247
7.4	Audio Settings	247
7.4.1	Various Tab	247
7.4.2	Channels Tab.....	248
7.4.3	Manual Audio Configuration	251
7.5	Authentication	252
7.5.1	Authentication Properties.....	253

7.5.2	Authentication Panel Procedures	254
7.6	Camera	257
7.6.1	Camera Properties	257
7.7	Communication	258
7.7.1	Global Properties	259
7.7.2	Shared Memory Properties	262
7.7.3	VDCP Properties.....	263
7.8	Clock Formats.....	264
7.9	Database	264
7.9.1	Global Properties	264
7.9.2	Failover Properties	266
7.9.3	Deploy Properties	267
7.10	Font and Text Options	268
7.11	Global Input.....	270
7.11.1	To Synchronize Multiple Viz Engines	270
7.12	Import 3D Options	271
7.13	Image File Name Convert	272
7.14	Local Settings	272
7.14.1	Select Multiple Directories.....	273
7.14.2	SAM SDC01, SDC02, and SDC03 protocols	273
7.15	Maps	275
7.15.1	To Add the VizWorld.ini File.....	276
7.16	Matrox.....	276
7.16.1	General Properties	277
7.16.2	VideoOut Properties.....	278
7.16.3	VideoIn Properties	280
7.17	Memory Management	285
7.18	Multiview	286
7.19	Path Aliases	287
7.19.1	To Add a Path.....	288
7.20	Output Format	288
7.20.1	UHDTV Support	290
7.21	Plug-ins	290
7.22	Render Options.....	291
7.23	Scene Default Values.....	295
7.23.1	Media Asset Configuration	296

7.24	Spaceball	296
7.25	User Interface	298
7.25.1	Various	299
7.25.2	Colors.....	303
7.25.3	Shortcuts	306
7.26	Video Board	307
7.26.1	Video Board Properties.....	307
7.27	Video Input.....	309
7.27.1	Live and Clip Channels.....	310
7.27.2	Stream Channels.....	310
7.27.3	No Onboard Video Board	311
7.28	Video Input: Clip Input.....	312
7.28.1	Clip Input Properties	312
7.29	Video Input: Stream Input	314
7.29.1	Stream Input Properties	315
7.29.2	MPEG-TS over RTP / UDP and RTPS Streaming	318
7.30	Video Output	322
7.30.1	Video Output Properties (1).....	322
7.30.2	Video Output Editor	322
7.31	Video Output: Clip Output	324
7.31.1	Placeholders for Variables.....	324
7.32	Video Output: SHM Output.....	325
7.33	Viz Artist 2.x	325
7.33.1	Viz Artist 2.x	325
7.34	Viz License Information	326
7.34.1	WIBU Licensing View	326
7.34.2	Old Hardlock Licensing View.....	327
7.35	Viz License Configuration	327
7.36	Viz One.....	329
7.36.1	Viz One Properties	330
7.37	Viz Artist/Engine Log Files	332
7.37.1	Viz Render Log	332
7.37.2	Viz Trace Log.....	332
7.37.3	Viz Gui Log	332
7.37.4	Viz Shaders Log	333
7.37.5	Viz Console Log.....	333
7.37.6	Viz Gui Connection Log	333

7.37.7	Create Log Files with Log and Clog Commands	333
8	On Air Mode	335
8.1	Director Control Pane	335
8.2	Control Buttons	336
8.3	Performance	337
8.3.1	Performance Analyzer	337
8.3.2	Performance Bar	338
8.4	On Air Information Panel.....	339
8.4.1	Basic Tab	339
8.4.2	Clients Tab	340
8.5	License Information	341
9	Video IO Related Configuration and Features	342
9.1	High Dynamic Range (HDR).....	342
9.1.1	Supported Color Formats	342
9.1.2	Requirements	344
9.1.3	Limitations	344
9.1.4	Configuration	344
9.2	Mixed Mode Video Support	345
9.2.1	Source: PAL or NTSC	345
9.2.2	Source: 720p	346
9.2.3	Source: 1080i	348
9.3	Frame Accurate Output	349
9.3.1	Prerequisites.....	349
9.3.2	Configure Frame Accurate Output.....	349
9.3.3	Commands	350
9.3.4	General Purpose I/O Commands	350
9.3.5	Timed Command Execution	354
9.4	Shared Usage of Input Channels.....	359
9.4.1	Configuration	359
9.4.2	Important	359
9.5	Dynamic Channel Allocation	360
9.5.1	Limitations	360
9.6	Supported Matrox Codecs.....	360
9.7	Configuration History for Matrox X.mio and DSX Series.....	361
9.7.1	Configuration History for Matrox X.Open	362
9.8	DVE Performance	362

9.8.1	General Information	363
9.9	Matrox Watchdog Configuration	364
9.9.1	Mechanical Bypass	364
9.9.2	Hardware Bypass	364
9.9.3	Transition from Watchdog to Video.....	364
9.9.4	To Enable Mechanical Bypass	365
10	Audio in Viz	366
10.1	Overview.....	366
10.1.1	Channels	367
10.1.2	Matrox Routing.....	367
10.1.3	DirectShow	368
10.2	Device Recognition and Selection.....	369
10.3	Timing Behavior and Delay Settings	369
10.3.1	Latency Adjustment on the DirectSound Audio Device.....	370
10.4	Channel Setup and Clip Channel Routing	372
10.4.1	To Test Audio Channel Setup.....	373
10.5	Audio Plug-in	373
10.6	Clip Formats	374
10.7	Speaker Names	374
10.8	Matrox Audio.....	374
10.8.1	To Enable Matrox Audio.....	375
10.9	Emergency Alert System.....	375
10.9.1	To specify output channels for EAS	375
10.10	Dolby E configuration	376
10.10.1	Enable DolbyE.....	376
10.10.2	Prepare for DolbyE Decoding	376
10.10.3	Prepare for DolbyE Encoding.....	377
10.10.4	Decode Plus Encode.....	377
10.10.5	Pass-through Mode.....	378
11	Shared Memory (SHM).....	379
11.1	External Data Input.....	379
11.1.1	SHM over TCP.....	380
11.1.2	SHM over UDP.....	381
11.1.3	Plug-in API	382
11.2	Internal Data (Interactive Scene).....	383
11.2.1	Example	384

11.3	Synchronization	384
11.3.1	TCP and UDP Synchronization	385
11.3.2	External Control Synchronization	386
11.3.3	Command Synchronization	387
11.4	Snapshot	387
12	Video Wall Configuration	389
12.1	Hardware Requirements and Recommendations	389
12.1.1	Minimum Hardware Configuration for Video Walls	389
12.1.2	Recommended Configuration for Video Walls	390
12.2	Performance Considerations	390
12.2.1	Hardware Considerations	390
12.2.2	Scene Design Considerations	391
12.3	Video Wall Setup Instructions	391
12.3.1	Pre-Requirements for All Setups	392
12.3.2	Configure the NVIDIA Driver for Video Wall	393
12.3.3	Order of Steps to Set Up NVIDIA Mosaic	393
12.3.4	NVIDIA Quadro Sync	394
12.3.5	Configuration Using Datapath Devices	395
12.3.6	Custom Resolution for 59.94 Hz Refresh Rate	399
12.3.7	NVIDIA Mosaic Configuration for 1080i50	404
12.3.8	NVIDIA Mosaic Configuration for 1080i60M	410
12.3.9	Viz Engine Video Wall Configuration Settings	415
12.4	Troubleshooting Video Wall Configurations	419
12.4.1	Performance Issues	419
12.4.2	Steps to Recover from Severe NVIDIA Mosaic Driver Related Issues	420
12.4.3	Experiencing BSOD or System Freeze while Setting up Mosaic	420
12.4.4	Only Some Displays of the Video Wall display an Image	420
12.4.5	Missing NVIDIA Control Panel Settings	420
12.4.6	NVIDIA Control Panel Crashes	421
12.4.7	Mosaic Configuration Not Supported Error	421
12.4.8	G-Sync Status LEDs or Topology Reports Indicate a Synchronization Issue	421
12.4.9	Poor Performance when Using GFX Channels as DVE	422
12.4.10	Jittering on HP Z840	422
12.4.11	Artist output appears scaled	422
12.4.12	Other Synchronization Issues	422
13	SNMP Support	423
13.1	Introduction	423

13.2	Installation.....	423
13.2.1	Prerequisites.....	423
13.2.2	To install the services	423
13.2.3	Installation.....	424
13.2.4	Configuration	425
13.3	SNMP Viz Engine OIDs.....	426
13.3.1	Viz Engine OIDs	426
13.3.2	Viz Engine Trap OIDs	430

This Administrator Guide gives details on the configuration and installation of Viz Engine. It also explains settings available through its configuration user interface.

The term Viz is used for the programs installed and run on the computer. This is used as a general reference for all modes of the program:

- Viz Artist (see the [Viz Artist User Guide](#))
- Viz Engine
- Viz Configuration

1 New In Viz Engine 3.13

1.1 NMOS IS-04 Support For SMPTE ST-2110 Infrastructure

As a first step, Viz Engine 3.13 supports [NMOS IS-04 Discovery and Registration](#) when used with Matrox X.mio3 IP, DSX LE4 IP or newer video cards. Viz Engine automatically registers senders and receivers at a configured RDS (Registration and Discovery Server) on the network. Control applications can change any receiver by sending a PUT request according to the IS-04 specifications.

1.2 NDI Support Using Matrox

In addition to the native NDI support, Viz Engine now supports [NDI within the Matrox](#) utilities implementation.

2 Introduction

This Administrator Guide gives details on the configuration and installation of Viz Engine. It also explains settings available through its configuration user interface.

The term Viz is used for the programs installed and run on the computer. This is used as a general reference for all modes of the program:

- Viz Artist (see the [Viz Artist User Guide](#))
- Viz Engine
- Viz Configuration

What mode of program that can run is determined from the hardware dongle that is attached to the actual machine (the different modes and the hardware dongle are detailed in this User Guide).

2.1 Related Documents

- *Viz Artist User Guide*: Contains information on how to install Viz Engine and create graphics scenes in Viz Artist.
 - *Viz Artist Script Reference*: Contains information on how to create scripts for a scene.
 - *Viz Engine Plug-in SDK Reference*: Contains information on how to create a customized Viz plug-in.
-

2.2 Feedback And Suggestions

We encourage suggestions and feedback about our products and documentation. To give feedback and/or suggestions, please contact your local Vizrt customer support team at www.vizrt.com.

3 New WIBU Based Licensing System

This chapter describes management and usage of the new licensing system based on CodeMeter from [WIBU Systems](#) available in Viz Engine 3.10 and later. It replaces the previous VALID/Sentinel/Hardlock Dongle licensing system and allows Viz Engine to be used without a physical dongle on each machine, by allocating licenses from a license server on the network. The old VALID/Sentinel/Hardlock Dongle licensing still works, as is.

On this page, you find the following information:

- [Important Pre-installation Information](#)
- [Key Features and Workflow of the New Licensing System](#)
- [Limitations and Known Issues](#)
- [Basic Set-up](#)
- [Configuration Settings](#)
 - [Why Do We Need to Configure the Licenses?](#)
 - [Configuring the License System in the Viz Engine Configuration UI](#)
 - [Monitor the License System in the Viz Engine Configuration UI](#)
 - [Configuration Entries in the Viz Engine Configuration File](#)
- [WIBU License System](#)
 - [Introduction](#)
 - [Summary of Key Concepts in the New Licensing System](#)
 - [Differences Compared to the Old VALID/Sentinel/Hardlock Licensing:](#)
 - [WIBU License Share Status](#)
 - [WIBU Core License Summary](#)
 - [WIBU Licenses and Their Effect](#)
- [Notes](#)
 - [Starting Viz Engine with WIBU License System](#)
 - [Starting Viz Engine with DVI OUT](#)
 - [Starting Viz Engine with MezzIP OUT and/or 1xMezzIP IN](#)
 - [Starting Viz Engine with NDI OUT and/or NDI IN](#)
 - [Starting Viz Engine with Frameserver Functionality \(MUX Ports\)](#)
 - [Starting Viz Engine with SDI/IP OUT or SDI/IP IN](#)
 - [Starting Viz Engine with Artist](#)
 - [Starting Viz Engine with Transition License - WIBU license bound to VALID/Sentinel dongle ID](#)
- [Setup Redundancy for a WIBU License Server](#)
 - [Steps to Setup Redundancy for a WIBU License Server](#)
 - [Test License Server Failover](#)
 - [Recover First License Server](#)
 - [Notes](#)

3.1 Important Pre-Installation Information

The WIBU licensing system requires the installation of the CodeMeter Runtime Software (included in the Bundle installer):

- 6.60a for 3.10.0 - 3.12.0
- 6.80 for 3.12.1 and newer

When the license should be retrieved from a dedicated license server, it must be configured in the Vizrt Licensing Service (see **Client Configuration** page in the **License Server Setup and Administration** section of the [Vizrt Licensing Administrator Guide](#)) or the CodeMeter WebAdmin.

i Info: There is an auto discovery if no license server is configured in the server search list of CodeMeter.

i Info: On network disconnect and reconnect, it may happen that a license is checked out twice. In this case, it must be released manually on the CodeMeter service on the license server or the license server can be restarted.

3.2 Key Features And Workflow Of The New Licensing System

- VALID/Sentinel/Hardlock Dongle is still working without any changes. The license system to run on can be configured.
 - **!** With Viz Engine 4.0.0 the VALID/Sentinel/Hardlock Dongle will not be supported anymore.
- Dongle-less operation on clients with monitoring and logging capabilities.
- Grace periods for allocated licenses to avoid immediate expiration on short network interruptions.
- Configurable WIBU license container location (local, network).
- Configurable licenses to consume.
- Artist/Engine startup was changed and no startup helpers are needed anymore (cmd files, started executables).

3.3 Limitations And Known Issues

- Only *one* license system can be used (VALID/Sentinel/Hardlock *or* WIBU/CodeMeter).
- The binary yes/no VM license introduced in 3.9.1 does not work anymore.
- The new WIBU licensing supports OEM starting with Viz Engine 3.12.1 and newer. OEM for VALID/Sentinel/Hardlock dongles is still supported.
- All additional licenses consumable to a core license must come from the same container as the core license.
- **!** Matrox DSX.Core license requests cause a crash if hostnames are used in the server search. As a workaround, please use only IP addresses and add them manually using the registry editor.
 - Add servers in registry or with the command line utility with IP-Addresses.

- **!** Matrox DSX.Core installer corrupts an existing CodeMeter Runtime installation and causes a crash on Engine startup.
 - Uninstall any CodeMeter Runtime prior to installing Matrox DSX.Core. Install DSX.Core and afterwards install the Engine and the newer CodeMeter Runtime.
- For a preview in TRIO and Pilot as Engine Core, a DVI OUT license is needed.
- In Viz Engine 3.12.1 and newer the configuration UI works without a valid license and can be configured through the configuration UI.
 - In Viz Engine 3.12.0 and older the configuration UI only works with a valid license, which depends on the configuration. If no proper license is available then a manual edit of the corresponding configuration entries is required. See [Configuration Entries in the Viz Engine Configuration File](#).
 - By default, the WIBU licensing system with Engine Core license (ENG_ENG_CORE) is used when no configuration exists.
- The icons of the Viz Artist and Viz Engine processes depend on the icon that was used to start the processes. When Viz Artist is started, the Viz Engine and Viz Artist process have the same icon.
- Extension of a VALID/Sentinel/Hardlock license requires to start the Engine in configuration mode with the configuration UI.

3.4 Basic Set-Up

To set up Viz Engine/Artist licensing with WIBU or VALID/Sentinel/Hardlock:

1. Install Viz Engine/Artist with the bundle installer (see [Viz Artist and Engine Installation](#)).
2. Configure CodeMeter with the [Vizrt Licensing Service](#) or the CodeMeter WebAdmin (can be opened from the CodeMeter Control Center).
3. Configure the license system in Viz Engine.

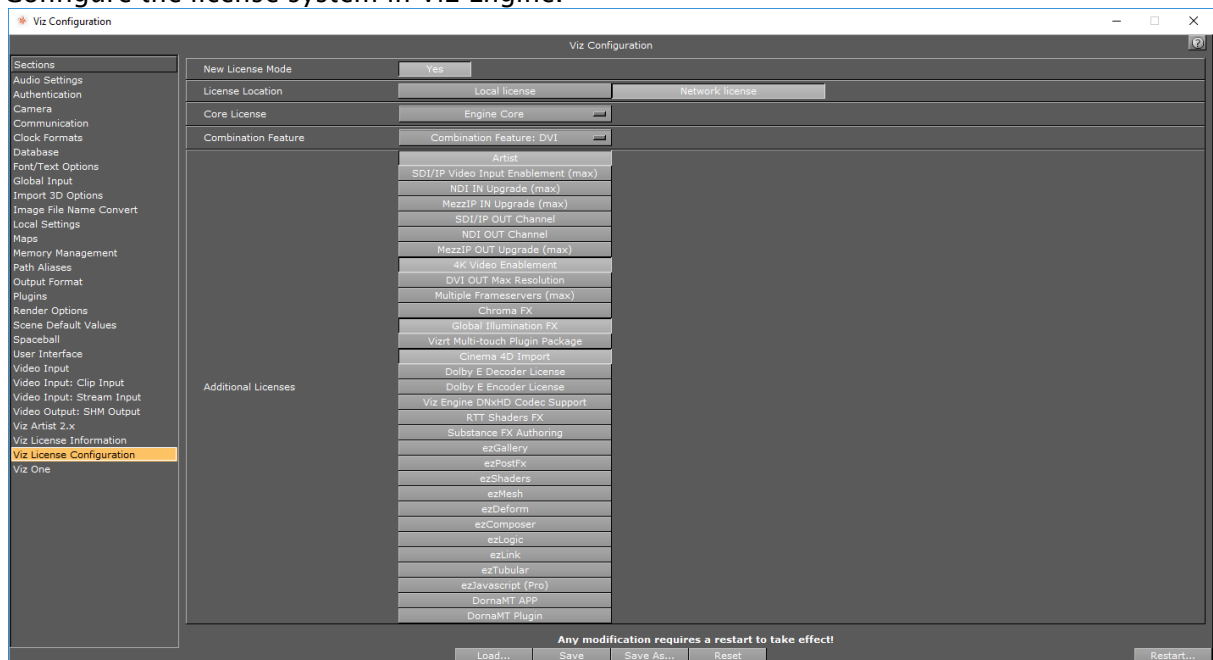

- a. When using a VALID/Sentinel/Hardlock license system:
 - i. Attach the VALID/Sentinel/Hardlock dongle to a USB port.

- ii. Configure to use legacy licensing. In the configuration UI under **Viz License Configuration** set **New License Mode** to `No` or in the Viz Engine configuration file set `Legacy_Licensing=1`.
 - b. When using a WIBU license server:
 - i. Open the CodeMeter WebAdmin and add the license server to the server search list.
 - ii. Configure Viz Engine to use the WIBU license system. In the configuration UI under **Viz License Configuration** set **New License Mode** to `Yes`, restart config and **License Location** to `Network license` or in the Viz Engine configuration file set `Legacy_Licensing=0` and `License_Location=VL_L_NETWORK`.
 - iii. Configure the core license and any additional licenses. In the configuration UI under **Viz License Configuration** configure **Core License**, **Additional Licenses** and **Combination Feature** or in the Viz Engine configuration file configure `License_Core` and `Additional_Licenses`.
 - c. When using a WIBU dongle:
 - i. Attach the WIBU dongle to any USB port of the machine.
 - ii. Configure Viz Engine to use the WIBU license system. In the configuration UI under **Viz License Configuration** set **New License Mode** to `Yes`, restart config and **License Location** to `Local license` or in the Viz Engine configuration file set `Legacy_Licensing=0` and `License_Location=VL_L_LOCAL`.
 - iii. Configure the core license and any additional licenses. In the configuration UI under **Viz License Configuration** configure **Core License**, **Additional Licenses** and **Combination Feature** or in the Viz Engine configuration file configure `License_Core` and `Additional_Licenses`.
 4. Start Viz Engine.
-

3.5 Configuration Settings

3.5.1 Why Do We Need to Configure the Licenses?

- Avoid license stealing by instances on other nodes or instances on the same node. Licenses are in one container and have a count.
- Several licenses may enable the same feature. There is no one to one mapping of application feature to a single license possible. For example, with multiple instances on one node (TRIO one box), it is important which instance consumes which license for proper operation (first needs SDI OUT, SDI IN and 2nd DVI OUT from the combination feature).
- A license may enable multiple internal application features.

3.5.2 Configuring the License System in the Viz Engine Configuration UI

See [Viz License Configuration](#).

Note: In Viz Engine 3.12.0 and older the Configuration UI only works with a valid license, which depends on the configuration. If no proper license is available, a manual edit of the corresponding configuration entries is required. See [Configuration Entries in the Viz Engine Configuration File](#). By default, the WIBU licensing system with Engine Core license (ENG_ENG_CORE) is used when no configuration exists. When no such license is available, or you want to use the old licensing system, the configuration file must be edited.

Note: Extension of a VALID/Sentinel/Hardlock license requires to start Viz Engine in configuration mode with the configuration UI.

3.5.3 Monitor the License System in the Viz Engine Configuration UI

See [Viz License Information](#).

3.5.4 Configuration Entries in the Viz Engine Configuration File

- **Legacy_Licensing:** Determines which license system should be used.
- Set this to 1 to use the VALID/Sentinel/Hardlock license system and 0 to use the WIBU license system.
- Default: When configuration exists on startup: 1, and when not 0.
- **License_Location:** WIBU license source. Determines where WIBU should search for license containers.
- Can be set to one of the following values:
 - VL_L_LOCAL - Local license. Searches exclusively for licenses located on the same PC or allocated to the same VM (e.g. dongle, file).
 - VL_L_NETWORK - Network license. License is to be sought in the network (LAN, WAN), i.e. CodeMeter License Server activated as network server or CmWAN.
- Only used when license system is WIBU.
- Default: VL_L_NETWORK
- **License_Core:** WIBU core license, which determines also the available additional licenses.
 - For WIBU license details see [WIBU Licenses and their effect](#).
 - Can be set to one of the following values:
 - ENG_ENG_CORE - Engine Core
 - ENG_PRV_CORE - Preview Core
 - ART_ARTIST_FREE - Artist Free
 - and for OEM
 - VIZLIB_LIBERO_CORE - Viz Libero Core
 - VIZARE_VIZARENA_CORE - Viz Arena Camera Tracking Engine
 - VIZECL_VIZECLIPSE_CORE - Viz Eclipse Core
- **Additional_Licenses:** WIBU additional licenses that are additionally consumed and determined by the core license.
 - For WIBU license details see [WIBU Licenses and their effect](#).

Note: When a license is configured it is consumed, even when it has no effect. If licenses are configured that are not allowed, an error occurs on startup.

- WIBU additional licenses for core license ENG_ENG_CORE:
 - Combination Feature (only one can be configured at a time):
 - ENG_CF(APP_DVI) - Combination Feature DVI
 - ENG_CF(APP_NDI) - Combination Feature NDI
 - ENG_CF(APP_MEZZ_IP) - Combination Feature MEZZ_IP
 - ENG_CF(APP_MUX_PORTS) - Combination Feature Frameserver
 - ENG_ARTIST - Artist
 - ENG_ING_SDIIP_MAX - SDI/IP Video Input Enablement (max)
 - ENG_IN_NDI_MAX - NDI IN Upgrade (max)
 - ENG_IN_MEZZIP_MAX - MezzIP IN Upgrade (max)
 - ENG_OUT_SDIIP - SDI/IP OUT Channel
 - ENG_OUT_NDI - NDI OUT Channel
 - ENG_OUT_MEZZIP_MAX - MezzIP OUT Upgrade (max)
 - ENG_ING_4KVIDEO - 4K Video Enablement
 - ENG_OUT_DVI_MAX - DVI OUT Max Resolution
 - ENG_OUT_FS_MAX - Multiple Frameservers (max)
 - ENG_PLUG_CHROMAFX - Chroma FX
 - ENG_PLUG_GI - Global Illumination FX
 - ENG_PLUG_MULTITOUCH - Vizrt Multi-touch Plug-in Package
 - ENG_PLUG_MOCAPREAD - Bone&Skin Live Motion Capture
 - ENG_PLROY_CINEMA4D - Cinema 4D Import
 - ENG_PLROY_DOLBYDEC - Dolby E Decoder License
 - ENG_PLROY_DOLBYENC - Dolby E Encoder License
 - ENG_PLROY_DNXHD - Viz Engine DNxHD Codec Support
 - ENG_PLROY_RTTFX - RTT Shaders FX
 - ENG_PLROY_SUBSAUTH - Substance FX Authoring
 - ENG_PLROY_EZGALLERY - ezGallery
 - ENG_PLROY_EZPOSTFX - ezPostFx
 - ENG_PLROY_EZSHADERS - ezShaders
 - ENG_PLROY_EZMESH - ezMesh
 - ENG_PLROY_EZDEFORM - ezDeform
 - ENG_PLROY_EZCOMPOSER - ezComposer
 - ENG_PLROY_EZLOGIC - ezLogic
 - ENG_PLROY_EZLINK - ezLink
 - ENG_PLROY_EZTUBULAR - ezTubular
 - ENG_PLROY_EZJSPRO - ezJavascript (Pro)
 - ENG_PLROY_DORNA_MTAP - DornaMT APP
 - ENG_PLROY_DORNA_MTPL - DornaMT Plug-in
- WIBU additional licenses for core license ENG_PRV_CORE:
 - ENG_PRV_ARTIST - Artist Preview
 - ENG_PLROY_CINEMA4D - Cinema 4D Import
 - ENG_PLROY_DOLBYDEC - Dolby E Decoder License
 - ENG_PLROY_DOLBYENC - Dolby E Encoder License
 - ENG_PLROY_DNXHD - Viz Engine DNxHD Codec Support
 - ENG_PLROY_RTTFX - RTT Shaders FX

- ENG_PLROY_SUBSAUTH - Substance FX Authoring
 - ENG_PLROY_EZGALLERY - ezGallery
 - ENG_PLROY_EZPOSTFX - ezPostFx
 - ENG_PLROY_EZSHADERS - ezShaders
 - ENG_PLROY_EZMESH - ezMesh
 - ENG_PLROY_EZDEFORM - ezDeform
 - ENG_PLROY_EZCOMPOSER - ezComposer
 - ENG_PLROY_EZLOGIC - ezLogic
 - ENG_PLROY_EZLINK - ezLink
 - ENG_PLROY_EZTUBULAR - ezTubular
 - ENG_PLROY_EZJSPRO - ezJavascript (Pro)
 - ENG_PLROY_DORNA_MTAP - DornaMT APP
 - ENG_PLROY_DORNA_MTPL - DornaMT Plug-in
 - WIBU additional licenses for core license ART_ARTIST_FREE: NONE
 - WIBU additional licenses for core license VIZLIB_LIBERO_CORE: NONE
 - WIBU additional licenses for core license VIZARE_VIZARENA_CORE: NONE
 - WIBU additional licenses for core license VIZECL_VIZECLIPSE_CORE: NONE
-

3.6 WIBU License System

3.6.1 Introduction

Summary of Key Concepts in the New Licensing System

- Core- and additional licenses exist.
- OUT based channel counting for NDI/SDI/IP
- IN and OUT channels are resolution independent up to 3G HD
 - <=2K size of render output
- Preview channels (preview/clean feed OUT) are co-enabled with every OUT channel license.
- MezzIP applies to all compressed streams:
- Included: RTP/UDP/WebRTC
- Excluded (requires SDI/IP licenses): SMTPE ST2022-06, ST2022-07, ST2110; ASPEN.
- Multiple licenses may enable the same application feature!
- Licenses are consumed by multiple processes and license share mode influences possible consumption (see [WIBU license share status](#)).

Differences Compared to the Old VALID/Sentinel/Hardlock Licensing:

- Only a small set of “features” can be directly mapped to the new license system (12 of 61).
- Several simplifications and included features, but some new restrictions (e.g. OUT+IN resolution limitations 2K, 4K).
- HW level is obsolete.

- OUTs are licensed.
- INs are licensed (AJA, DVS).
- No restrictions anymore on Clips/Clip Player in ENG_ENG_CORE and plug-ins included in ENG_ENG_CORE.
- No restrictions anymore on Video Preview OUT.
- No multi GPU restrictions anymore.

3.6.2 WIBU License Share Status

Refers to a WIBU license and how its usage is counted when it is allocated/consumed.

- **Exclusive:** Allocation can only be performed once on a node (=machine).
- **User Limit:** Each allocation is counted, independent of instance and node.
- **Shared:** Each allocation is counted once per node. Multiple allocations on the same node allocate only a single license.
- **No User Limit:** Only checked for existence, no counting is performed.

License count reduction when consumed on a node in an instance						
License share status	Node 1			Node 2		
	Instance 1	Instance 2	Instance 3	Instance 1	Instance 2	Instance 3
Exclusive	-1	fails	fails	-1	fails	fails
User Limit	-1	-1	-1	-1	-1	-1
Shared	-1	0	0	-1	0	0
No User Limit	0	0	0	0	0	0

3.6.3 WIBU Core License Summary

The following table represents which features are included in one of the Core features and what additional feature might need to be configured.

License	Engine Core	Preview Core	Artist Free	Service Host
Artist	✔ ENG_ARTIST	✔ ENG_PRV_ARTIST	✔	✘

Clips / Clip Player	✓	✓	✓	✗
Engine Core plug-ins	✓	✓	✓	✗
SDI/IP Input	✓ ENG_ING_SDIIP_MAX	✓	✗	✗
SDI/IP Output	✓ ENG_OUT_SDIIP	✓ (Watermark)	✗	✗
NDI Input	✓ ENG_CF(APP_NDI) or ENG_IN_NDI_MAX	✓	✗	✗
NDI Output	✓ ENG_CF(APP_NDI) or ENG_OUT_NDI	✓ (Watermark)	✗	✗
Mezzanine IP in	✓ ENG_CF(APP_MEZZ_IP) or ENG_IN_MEZZIP_MAX	✓	✗	✗
Mezzanine IP out	✓ ENG_CF(APP_MEZZ_IP) or ENG_OUT_MEZZIP_MAX	✓ (Watermark)	✗	✓ ENG_CF(APP_MEZZ_IP) or ENG_OUT_MEZZIP_MAX
Frameserver	✓ ENG_CF(APP_MUX_PORTS) or ENG_OUT_FS_MAX	✗	✗	✗

DVI Out (<=2K)	✓ ENG_CF(APP_DVI) or ENG_OUT_DVI_MAX	✓ (Watermark on Resolution >=PAL)	✓ Watermark	✗
Unlimited DVI Out (Videowall)	✓ ENG_OUT_DVI_MAX	✓ (Watermark)	✓ (Watermark)	✗
4K Enablement	✓ ENG_ING_4KVIDEO	✓ (Watermark on Resolution >=PAL)	✓ (Watermark)	✓ ENG_ING_4KVIDEO
Unlimited Frameserver	✓ ENG_OUT_FS_MAX	✗	✗	✗
Chroma Keyer	✓ ENG_PLUG_CHROMAFX	✓	✗	✗
Global Illumination	✓ ENG_PLUG_GI	✓	✗	✗
Multitouch Plug-ins	✓ ENG_PLUG_MULTITOUCH	✓	✗	✗
Bone&Skin Live Motion Capture	✓ ENG_PLUG_MOTIONCAPREAD	✓	✗	✗
Cinema 4D Import	✓ ENG_PLROY_CINEMA4D	✓ ENG_PLROY_CINEMA4D	✗	✗
RTT Shaders	✓ ENG_PLROY_RTTFX	✓ ENG_PLROY_RTTFX	✗	✗
Substance Shader	✓ ENG_PLROY_SUBSTANCEAUTH	✓ ENG_PLROY_SUBSTANCEAUTH	✗	✗
Dolby E Encoding	✓ ENG_PLROY_DOLBYENC	✓ ENG_PLROY_DOLBYENC	✗	✗

Dolby E Decondig	✓ ENG_PLROY_D OLBYDEC	✓ ENG_PLROY_DOLBY DEC	✗	✗
DNxHD Codec	✓ ENG_PLROY_D NXHD	✓ ENG_PLROY_DNXHD	✗	✗
Erizos Plug-ins	✓ ENG_PLROY_EZ xxxx	✓ ENG_PLROY_EZxxxx	✗	✗
Dorna Plug-ins	✓ ENG_PLROY_D ORNA_xxxx	✓ ENG_PLROY_DORNA _xxxx	✗	✗

3.6.4

WIBU Licenses and Their Effect

A WIBU license is a dedicated license (application ID) in the WIBU license system.



License short name License long name	WIBU Share Status	Description
Core Licenses		Core licenses are used as prerequisite for other licenses and define the basic feature set.
ENG_ENG_CORE Engine Core	Shared	<p>Basic core license to be able to start Viz Engine.</p> <p>Included functionality:</p> <ul style="list-style-type: none"> · GFX · only boundary is the channel resolution/size (2K). · Clips / Clip Player · No limits on Clip Player (incl. broadcast format clip playback - of course proper Matrox Codecs required) · Plug-ins · Image FX · Real FX · Spline FX · Text FX · Pixel FX · Graffiti FX · Weather FX · SocialTV FX (NOTE: was never restricted) · Engine 3D Stereo Upgrade (=3D Stereo) · EVS Control Plug-in · Geo FX · Engine functionality: <ul style="list-style-type: none"> · Audio FX · Video FX · After Effects Import · Postrender 2K <ul style="list-style-type: none"> · With ENG_ING_4KVIDEO up to 4K · With ENG_OUT_DVI_MAX unlimited · Postrender on screen preview has a watermark, except when postrendering is actually performed <p>Comes in combination with the following licenses:</p> <ul style="list-style-type: none"> · ENG_CF · ENG_SVCHOST_COR

		· ENG_ARTIST
--	--	--------------

ENG_PRV_CORE Preview Core	User Limit	<p>Usage 1: Trio / other client applications requiring local preview</p> <p>Usage 2: Standalone preview machine for DVI, Mezzanine, NDI or SDI output always with watermark</p> <p>Disabled:</p> <ul style="list-style-type: none"> · ENG_CF · Frameserver (Network) OUT · ENG_OUT_FS_MAX · Frameserver (Network) OUT <p>Enabled (if licensed):</p> <ul style="list-style-type: none"> · Artist (together with ENG_PRV_ARTIST) · 3DP plug-ins if license is available <p>Included functionality:</p> <ul style="list-style-type: none"> · All resolutions · ENG_ING_4KVIDEO · ENG_OUT_DVI_MAX · All plug-ins from ENG_ENG_CORE enabled · All internal plug-ins · ENG_PLUG_CHROMAFX · ENG_PLUG_GI · ENG_PLUG_MULTITOUCH · All INs enabled · ENG_ING_SDIIP_MAX · ENG_IN_NDI_MAX · ENG_IN_MEZZIP_MAX · 1xOUT enabled (no extra licenses required) · ENG_OUT_SDIIP · ENG_OUT_NDI · ENG_OUT_MEZZIP_MAX <p>Watermark on all OUTs at any time and all resolutions</p> <ul style="list-style-type: none"> · DVI OUT <div style="border: 1px solid orange; padding: 5px; margin: 10px 0;"> <p> Note: No watermark on DVI OUT (local preview) and renderer snapshots when the resolution is <= 720x576 pixels (PAL, SD). Output system must be set to PAL/SD.</p> </div> <ul style="list-style-type: none"> · SDI OUT · MezzIP OUT
------------------------------	------------	--

		<ul style="list-style-type: none"> · RTP/UDP OUT · WebRTC OUT (SHM OUT) · NDI OUT · Postrender · Clip Out Channel · SHM
ART_ARTIST_FREE Artist Free	Exclusive	<p>Free Viz Artist version core license.</p> <p>Equal to an ENG_ENG_CORE with 1 x DVI OUT (limited to 2K) and everything is watermarked, except scene editor (small window in bottom right).</p> <ul style="list-style-type: none"> · Enabled: <ul style="list-style-type: none"> · Artist · GFX · Clips / Clip Player · Plug-ins of ENG_ENG_CORE · Restricted: <ul style="list-style-type: none"> · Watermark on all OUTs including Postrender, Clip Out · Not combinable with any other license · Means no SDI/IP, NDI, RTP/UDP IN/OUT, WebRTC OUT
ENG_SVCHOST_CORE Service Host Core	Shared	<p>Shipped with ENG_ENG_CORE.</p> <p>Basic core license to be able to start ServiceHost with WebRTC.</p> <p>Basic license to be able to consume the ENG_CF, ENG_ING_4KVIDEO and ENG_OUT_MEZZIP_MAX.</p>

Core Addons		
ENG_CF(APP_DVI) ENG_CF(APP_NDI) ENG_CF(APP_MEZZ_IP) ENG_CF(APP_MUX_PORTS) Combination Feature	Exclusive	Shipped with and requires ENG_ENG_CORE. Requires ENG_ENG_CORE or ENG_SVCHOST_COR. Allows you to mutually exclusive pick (configure) one of the following: <ul style="list-style-type: none"> • APP_DVI: 1x DVI Out (2K) - meant to operate Artist, or feed an HD Monitor. • APP_MEZZ_IP: 1x MezzIP IN (2K), 1x MezzIP OUT (2K) • 1x WebRTC OUT(2K) - allows to stream Viz Engine output to a browser. <div style="border: 1px solid orange; padding: 5px; margin: 10px 0;"> <p>⚠ Note: Consumed by ServiceHost.</p> </div> <ul style="list-style-type: none"> • 1x RTP/UDP IN (2K), 1x RTP/UDP OUT (2K) • APP_NDI: 1x NDI IN (2K), 1x NDI OUT (2K) • APP_MUX_PORTS: 1x Frameserver OUT (2K) • Enable/Disable Vizrt Frame Server and NLE plug-ins with this license. No NLE plug-in should work anymore. <div style="border: 1px solid orange; padding: 5px; margin: 10px 0;"> <p>⚠ Note: The ENG_CF is not mandatory to be consumed if the additionally consumed license (example: DVI Max. Resolution == video wall setup) is sufficient for the customer to make the node operational.</p> </div>
ENG_ARTIST Artist	No User Limit	Shipped with and requires ENG_ENG_CORE. Basic license to be able to start the Viz Artist.
ENG_PRV_ARTIST Artist Preview	User Limit	Shipped with and requires ENG_PRV_CORE. Basic license to be able to start the Viz Artist with Preview Core.
Input licenses		
ENG_ING_SDIIP_MAX SDI/IP Video Input Enablement (max)	Shared	Requires ENG_ENG_CORE or ING_ING_CORE. SDI/IP Video Input (unlimited channels)
ENG_IN_NDI_MAX NDI IN Upgrade (max)	Shared	Requires ENG_ENG_CORE. Additional NDI streams require unlimited version of respective stream type

ENG_IN_MEZZIP_MAX MezzIP IN Upgrade (max)	Shared	Requires ENG_ENG_CORE. Additional RTP/UDP streams require unlimited version of respective stream type
Output licenses		
ENG_OUT_SDIIPSDI /IP OUT Channel	User Limit	Requires ENG_ENG_CORE. Referring to: SMPTE ST2022-06, ST2022-07, ST2110; ASPENFill+Key is considered to be one channel only (even though requiring two physical outs). Preview channels (preview/clean feed OUT) are co-enabled with every SDI/IP OUT channel license item being purchased.
ENG_OUT_NDINDI OUT Channel	User Limit	Requires ENG_ENG_CORE. Additional NDI streams.
ENG_OUT_MEZZIP_MAX MezzIP OUT Upgrade (max)	Shared	Requires ENG_ENG_CORE or ENG_SVCHOST_COR. Additional RTP/UDP streams.
Other Licenses		
ENG_ING_4KVIDEO 4K Video Enablement	Shared	Requires ENG_ENG_CORE or ENG_SVCHOST_COR. 4K IN and OUT: SDI/IP, NDI, MezzIP (RTP/UDP, WebRTC), postrender. Does not apply to DVI OUT (requires ENG_OUT_DVI_MAX).  Note: Allows IN and OUT of <=4K in both dimensions.
ENG_OUT_DVI_MAX DVI OUT Max Resolution	Shared	Requires ENG_ENG_CORE. Required to unlock 2K DVI OUT limit (e.g. for Video walls) and postrender resolution.  Note: No DVI OUT size restriction anymore.
ENG_OUT_FS_MAX Multiple Frameservers (max)	Shared	Requires ENG_ENG_CORE. Multiple Frame Server instances per Node.

Plug-in Licenses		
ENG_PLUG_CHROM AFX Chroma FX	Shared	Requires ENG_ENG_CORE.
ENG_PLUG_GI Global Illumination FX	Shared	Requires ENG_ENG_CORE.
ENG_PLUG_MULTIT OUCH Vizrt Multi-touch Plug-in Package	Shared	Requires ENG_ENG_CORE.
ENG_PLUG_MOCAP READ Bone&Skin Live Motion Capture	User Limit	Requires ENG_ENG_CORE.
3rd Party Plug-in Licenses		
ENG_PLROY_CINEM A4D Cinema 4D Import	Shared	Requires ENG_ENG_CORE or ENG_PRV_CORE.
ENG_PLROY_DOLBY DEC Dolby E Decoder License	Shared	Requires ENG_ENG_CORE or ENG_PRV_CORE.
ENG_PLROY_DOLBY ENC Dolby E Encoder License	Shared	Requires ENG_ENG_CORE or ENG_PRV_CORE.
ENG_PLROY_DNXH D Viz Engine DNxHD Codec Support	Shared	Requires ENG_ENG_CORE or ENG_PRV_CORE.
ENG_PLROY_RTTFX RTT Shaders FX	Shared	Requires ENG_ENG_CORE or ENG_PRV_CORE.
ENG_PLROY_SUBSA UTH Substance FX Authoring	Shared	Requires ENG_ENG_CORE or ENG_PRV_CORE.
ENG_PLROY_EZGAL LERY ezGallery	Shared	Requires ENG_ENG_CORE or ENG_PRV_CORE. Erizos licenses.

ENG_PLROY_EZPOSTFX ezPostFx	Shared	
ENG_PLROY_EZSHADERS ezShaders	Shared	
ENG_PLROY_EZMESH ezMesh	Shared	
ENG_PLROY_EZDEFORM ezDeform	Shared	
ENG_PLROY_EZCOMPOSER ezComposer	Shared	
ENG_PLROY_EZLOGIC ezLogic	Shared	
ENG_PLROY_EZLINK ezLink	Shared	
ENG_PLROY_EZTUBULAR ezTubular	Shared	
ENG_PLROY_EZJAVASCRIPT ezJavascript (Pro)	Shared	
ENG_PLROY_DORNA_MTAP DornaMT APP	Exclusive	Requires ENG_ENG_CORE or ENG_PRV_CORE. Dorna licenses.
ENG_PLROY_DORNA_MTPL DornaMT Plug-in	Exclusive	

3.7 Notes

3.7.1 Starting Viz Engine with WIBU License System

- User configured in Viz Engine configuration which license(s) should be used/consumed.
- A core license is required to start Viz Engine.

- To enable higher resolutions postrendering (>2K) then use:
 - ENG_ING_4KVIDEO for up to <=4K width/height.
 - ENG_OUT_DVI_MAX for unlimited resolution.

3.7.2 Starting Viz Engine with DVI OUT

- User configured DVI OUT in Engine configuration file: No Videoout, onair_vga_preview=1 or VGA version, startup in Engine or Artist mode.
- The following licenses need to be available in WIBU license system:
 - ENG_CF(APP_DVI) (resolution limited to <=2K width/height).
 - OR ENG_OUT_DVI_MAX (no resolution restriction).
- When configuration is changed at runtime and violates the license restriction, the resolution is limited to the allowed resolution (e.g. 2K width/height).
- DVI OUT is required for local preview in external applications (e.g. TRIO, Pilot Template Wizard, Pilot Director).
- When resolution is higher than 2K the startup fails for ENG_ENG_CORE without a proper ENG_ING_4KVIDEO or ENG_OUT_DVI_MAX license.

3.7.3 Starting Viz Engine with MezzIP OUT and/or 1xMezzIP IN

- Without the ENG_ING_4KVIDEO license the input/output is limited to <=2K width/height.
- When running Engine with RTP/UDP IN/OUT or ServiceHost with WebRTC OUT the following licenses need to be available in the WIBU license system:
 - OUT: ENG_CF(APP_MEZZ_IP) OR ENG_OUT_MEZZIP_MAX
 - IN: ENG_IN_MEZZIP_MAX
- To enable resolutions >2K and <= 4K then ENG_ING_4KVIDEO is required.
- ENG_CF is limited when ServiceHost WebRTC is used. This happens because the license is consumed by the ServiceHost and cannot be consumed anymore by the Viz Engine, because of the exclusive license share status. The ENG_CF is consumed together with ENG_SVCHOST_COR .
- In short:
 - When RTP/UDP IN/OUT (2K) is used then the ENG_CF on the Engine is sufficient.
 - When WebRTC OUT (2K) is enabled through the ENG_CF on the ServiceHost then ENG_IN_MEZZIP_MAX is required on the Engine for MezzIP IN (2K).
 - When MezzIP IN (2K) is enabled through the ENG_CF on the Engine then ENG_OUT_MEZZIP_MAX is required on the ServiceHost for MezzIP OUT (2K) with WebRTC.

MezzIP Possible OUTs	Engine effect	Engine licenses consumed	ServiceHost effect	ServiceHost licenses consumed
1 RTP/UDP IN (2K), 1 RTP/UDP OUT (2K)	Instance 1: 1x RTP/UDP IN (2K), 1x RTP/UDP OUT (2K)	1 ENG_ENG_CORE, ENG_CF	-	-
1 WebRTC OUT (2K) MezzIP IN not possible with ENG_CFor only	not possible since ENG_CF is consumed by ServiceHost	1 ENG_ENG_CORE	1x WebRTC OUT (2K)	ENG_SVCHOST_C OR, ENG_CF
1+ RTP/UDP IN (2K), 1 WebRTC OUT (2K)	1+ RTP/UDP IN (2K) (one or multiple instances)	1(+) ENG_ENG_CORE, ENG_IN_MEZZIP_MAX	1x WebRTC OUT (2K)	ENG_SVCHOST_C OR, ENG_CF
1 RTP/UDP IN (2K), 1+ WebRTC OUT (2K), 1+ RTP/UDP OUT (2K)	1 RTP/UDP IN (2K)	ENG_ENG_CORE, ENG_CF, ENG_OUT_MEZZIP_MAX	1+ WebRTC OUT (2K)	ENG_SVCHOST_C OR, ENG_OUT_MEZZIP_MAX
1+ RTP/UDP IN (2K), 1+ WebRTC OUT (2K), 1+ RTP/UDP OUT (2K)	1+ RTP/UDP IN (2K) 1+ RTP/UDP OUT (2K)	ENG_ENG_CORE, ENG_IN_MEZZIP_MAX, ENG_OUT_MEZZIP_MAX	1+ WebRTC OUT (2K)	ENG_SVCHOST_C OR, ENG_OUT_MEZZIP_MAX
4K IN/OUT	4K resolution on any IN/OUT	ENG_ING_4KVIDEO	4K resolution on WebRTC OUT	ENG_ING_4KVIDEO

Starting Viz Engine with NDI OUT and/or NDI IN

- When running Engine with NDI IN and/or NDI OUT the following licenses need to be available in the WIBU license system:
 - OUT: ENG_CF(APP_NDI) OR ENG_OUT_NDI
 - IN: ENG_IN_NDI_MAX
- To enable resolutions >2K and <= 4K then ENG_ING_4KVIDEO is required.

3.7.4 Starting Viz Engine with Frameserver Functionality (MUX Ports)

- When running Engine as a frameserver (e.g. for NLE clients or Viz Story) the following licenses need to be available in the WIBU license system:
 - ENG_CF(APP_MUX_PORTS) to start one frameserver instance per node
 - OR ENG_OUT_FS_MAX to start multiple frameserver instances per node
- To enable higher resolutions frameserver snapshots (>2K) then use:
 - ENG_ING_4KVIDEO for frameserver snapshots of up to <=4K width/height.
 - ENG_OUT_DVI_MAX for unlimited resolution frameserver snapshots.

⚠ Note: The Multiplexer Ports are only opened if a default renderer is active. Therefore, please make sure `create_default_renderer = 1` is set in the config file.

⚠ Note: The preview port (typically 50010) is not part of the Multiplexer ports. It is not restricted by any license.

3.7.5 Starting Viz Engine with SDI/IP OUT or SDI/IP IN

- When running Engine with SDI/IP IN and/or SDI/IP OUT the following licenses need to be available in the WIBU license system:
 - OUT: ENG_OUT_SDIIP per output one license is consumed
 - IN: ENG_ING_SDIIP_MAX
- To enable higher resolutions SDI/IP OUT/IN (>2K) use:
 - ENG_ING_4KVIDEO for up to <=4K width/height.

3.7.6 Starting Viz Engine with Artist

- When running Engine with Artist the following licenses need to be available in the WIBU license system:
 - ENG_ENG_CORE and ENG_ARTIST
 - OR ENG_PRV_CORE and ENG_PRV_ARTIST
 - OR ART_ARTIST_FREE

3.7.7 Starting Viz Engine with Transition License – WIBU license bound to VALID/Sentinel dongle ID

- Transition license has a special flag in the core license and is bound to the old VALID/Sentinel dongle ID.
- This license is node bound. It should not be added to a license server, else it cannot be distinguished from other licenses and may be allocated at the wrong node or instance.
- The dongle ID in the WIBU license must match to the dongle ID of the VALID/Sentinel dongle to enable the WIBU license and to start Viz Engine.

- Only WIBU licenses are used. Features on the old VALID/Sentinel dongle are completely ignored.
- When VALID/Sentinel dongle is unplugged or expires then WIBU license expires too.
- Plug-ins that query the VALID/Sentinel ID get a Zero-ID, since WIBU is used.

3.8 Setup Redundancy For A WIBU License Server

Below is outlined how to properly setup WIBU license server redundancy. See [Vizrt Licensing Administrator Guide](#) in **License Server Redundancy** for additional details.

 **Note:** The grace period for acquired licenses is one hour if the license is lost to recover possible network issues or the license server.

3.8.1 Steps to Setup Redundancy for a WIBU License Server

- Make sure two hosts (A & B) have *VizrtLicensingInstaller.exe* installed and select **use as network license server** during installation. See [Vizrt Licensing Administrator Guide](#) in **License Server Activation**.
- Connect one WIBU dongle to 'A' and import a key with licenses.
- From WIBU web admin UI of 'A', make sure the container exist and all the added features are listed.
- On the client configure 'A' as first license server, and 'B' as second one (in the search list of the local CodeMeter web admin).

3.8.2 Test License Server Failover

- Set the license configuration in the Engine.
- Start the engine.
- From CodeMeter web admin UI of 'A', verify that the licenses are allocated and used by the client.
- Disconnect the network cable of 'A' or shut down the machine.
- Wait until the Engines starts writing 'License Server not found..' and the grace status for the configured features is 'grace_state=2/VL_GRACE_GRACE, '.
- Move the WIBU dongle from 'A' to 'B'.
- Engine recovers and re-obtains the license from 'B'.

3.8.3 Recover First License Server

- Recover license server 'A'.
- Disconnected the failover license server from network or shut it down.
- Waited until Engines enter grace period.
- Moved WIBU dongle back to the original license server 'A'.
- Engine recovers and re-obtains the license from 'A'.

3.8.4 Notes

- The license must be in the same container to recover. A second license server with a different container does not work.
- Not started Engines which are configured the same, can start and obtain the license from 'B'.
- An arbitrary number of servers can be added to the server search list of CodeMeter, even when the Engine is running. It is possible to add a failover server after the original license server failed.

See Also

- [Vizrt Licensing Administrator Guide](#)

4 Software Configuration

This section details the prerequisites and supported options for the Viz Engine/ Artist installation, and procedures on how and where to install Viz Artist/Engine.

This section contains information on the following topics:

- [Prerequisites](#)
- [Viz Artist and Engine Folders](#)
- [Supported Software](#)
- [Ports and Connections](#)
- [User Account Control](#)
- [Viz Artist and Engine Installation](#)
- [Viz Artist and Engine Platforms](#)
- [Install the Legacy Hardlock Based Viz License](#)
- [EVS Video Server Control](#)
- [Dual Channel Mode](#)
- [Trio Box CG Mode](#)
- [Integration with Viz One](#)
- [Viz Engine REST interface](#)
- [Dolby E Support](#)
- [Newtek NDI](#)

4.1 Prerequisites

- [Supported Operating Systems](#)
- [Virtual Environments](#)
- [Environmental settings](#)
- [Hardware and BIOS settings](#)
- [Power Management Settings](#)
- [User Rights](#)
- [Secure Boot](#)
- [Running Viz Engine and Viz Artist without Administrator Rights](#)
- [Anti-Virus Software](#)

4.1.1 Supported Operating Systems

Viz Artist and Engine runs on the following platforms:

Viz Artist/Engine version	Operating System
3.13	<ul style="list-style-type: none"> • Windows Server 2008 R2/SP1 (64-bit) • Windows Server 2016 • Windows Server 2012 R2 • Windows 7 (64-bit) • Windows 10 (64-bit) 1809 • Windows 10 IoT/LTSC Edition
3.12	<ul style="list-style-type: none"> • Windows Server 2008 R2/SP1 (64-bit) • Windows Server 2016 • Windows Server 2012 R2 • Windows 7 (64-bit) • Windows 10 (64-bit) 1809 • Windows 10 IoT Edition
3.11	<ul style="list-style-type: none"> • Windows Server 2008 R2/SP1 (64-bit) • Windows Server 2016 • Windows Server 2012 R2 • Windows 7 (64-bit) • Windows 10 (64-bit) • Windows 10 IoT Edition
3.10	<ul style="list-style-type: none"> • Windows Server 2008 R2/SP1 (64-bit) • Windows Server 2016 • Windows Server 2012 R2 • Windows 7 (64-bit) • Windows 10 (Fall Creators Update) (64-bit) • Windows 10 IoT Edition
3.9.0	<ul style="list-style-type: none"> • Windows Server 2008 R2/SP1 (64-bit) • Windows Server 2016 • Windows Server 2012 R2 • Windows 7 (64-bit) • Windows 10 (Creators Update) (64-bit)
3.8.3, 3.8.2	<ul style="list-style-type: none"> • Windows Server 2012 R2 • Windows 7 (64-bit only)
3.8.1, 3.8.0, 3.7.2	<ul style="list-style-type: none"> • Windows Server 2008 R2/SP1 (64-bit) • Windows 7 (64-bit only)

Viz Artist/Engine version	Operating System
3.7.1, 3.7.0	<ul style="list-style-type: none"> Windows Server 2008 R2/SP1 (64-bit) Windows 7 (64-bit and 32-bit)
3.6.4	<ul style="list-style-type: none"> Windows Server 2008 R2/SP1 (64-bit) Windows 7 (64-bit).Windows XP SP3 (32-bit)

For optimal performance, use the pre-installed Windows image from Vizrt. You can obtain the Windows image files from your [local support office](#).

Note: Only English Operating System(s) are supported.

Note: Matrox requires a 64-bit operating system. Future nVidia drivers will also require a 64-bit operating system.

4.1.2 Virtual Environments

The following virtual environments have been tested and certified to host Viz Engines:

- Amazon AWS cloud
- Microsoft Azure
- VMWare ESxi (6.0, 6.5)
- fra.me
- AliBaba Cloud

Note: Backup and Restore on Azure systems is currently not supported.

4.1.3 Environmental settings

The following prerequisites apply on all platforms. Applying the changes may require local administrator access rights, new or changing group policy entries, or modifying services. Contact your local IT manager for further instructions.

Perform all Windows Updates, except hardware driver updates. This is especially important for drivers related to nVidia and Matrox hardware, and the Sentinel Hardlock or Codemeter dongle drivers. In addition to this;

- In Windows, the Aero theme must be disabled.
- Turn off balloon tips.
- Turn off windows sounds.
- Turn off AutoPlay.
- Turn off Windows Media Player Network Sharing Service.
- Disable Windows Defender.

Set **Visual Effects** to **Adjust for best performance**. This is set in the Performance Options window; right click the Start button and select **System**, then select **Advanced system settings** and click the **Settings** button in the **Performance** section.

4.1.4 Hardware and BIOS settings

The following considerations must be made regarding hardware:

- There must only be one active network card.
- Hardware must be installed, and BIOS configured, as suggested for the machine model.

4.1.5 Power Management Settings

Power management and hibernation mode must set to *Off*. Execute `powercfg -h off` from the command line to remove *hiberfil.sys* from the hard disk.

In addition to this, set the following under Power Options:

- Never turn off display.
- Never turn off hard disks.
- Disable USB selective suspend setting.
- Set Power button action to **Do nothing**. This prevents accidental shutdown in case someone presses the power button by mistake.

4.1.6 User Rights

The user must have special rights to run Viz Artist and Viz Engine. This can be achieved by assigning local administrator rights to the user, or by explicitly granting the required privileges. See Running Viz Engine and Viz Artist without administrator rights below for further details.

Any hardware solution provided by Vizrt is certified for use with Viz Engine. These come with a predefined default User that has administrator rights on the machine. The default administrator account is as follows:

User name	Password	Account Type
Admin	vizrt	Computer Administrator

 **IMPORTANT!** Make sure that you change this password after initial installation!

4.1.7 Secure Boot

Matrox drivers require a special version (labeled *_EV.exe*) for installing on secure boot enabled systems. If your driver fails to install, please disable secure boot in the BIOS settings.

To learn more about the different user account types, refer to the Windows operating system documentation, or visit www.microsoft.com.

4.1.8 Running Viz Engine and Viz Artist without Administrator Rights

There might be restrictions on user rights in some production environments. Although execution of Viz Engine and Viz Artist normally requires local administrator rights, it is possible to manually adjust the rights of the executing user by granting the following four privileges:

- SeIncreaseBasePriorityPrivilege
- SeCreateGlobalPrivilege
- SeCreatePagefilePrivilege
- SeIncreaseWorkingSetPrivilege

 **IMPORTANT!** Please contact your local IT manager for further information on how this is handled within the organization.

4.1.9 Anti-Virus Software

Anti-Virus software, including end-point protection, can cause various problems such as time-out and performance issues on the Graphic Hub database and other Vizrt machines, as every file is checked. To avoid these problems, make sure to exclude the *VizDb.exe* process and the underlying Graphic Hub data directory (default *D:\VizGHData* or *E:\VizGHData*) in the scan/real-time settings of the Anti-Virus software.

If any Anti-Virus software is used without the above settings, optimal performance cannot be guaranteed, nor the long-term stability of Vizrt products.

There are hundreds of Anti-Virus software packages on the market. We do not recommend the use of any specific Anti-Virus software package or version, or give any recommendations on how to setup any Anti-Virus software suites in relation to Vizrt software and machines.

See Also

- [Viz Artist and Engine Folders](#)
- [Supported Software](#)

4.2 Viz Artist And Engine Folders

This section details the location of the Viz Artist/Engine default installation and data folders.

4.2.1 Installation Folders

The default installation folders are:

Windows System	Viz Artist/Engine Platform	Installation Folder
Windows 64-bit	32-bit	<i>C:\Program Files (x86)\vizrt\Viz3</i>

Windows System	Viz Artist/Engine Platform	Installation Folder
	64-bit	C:\Program Files\vizrt\Viz3\ C:\Program Files\vizrt\Viz3\artist (user Interface)

In this Administrator Guide, any reference to the Viz Artist and Engine installation folder, for example C:\Program Files\vizrt\Viz3, is replaced with the text <viz install folder>.

Note: Viz Config files that already exist from a previous installation are automatically copied on install time if the installation folder did not change. If Viz Engine/Artist is installed in a different installation folder then Viz Config files must be manually copied from the old installation folder to <viz data folder>.

4.2.2 Data Folders

Files which are created or modified by Viz Artist/Engine are located at %ProgramData%\vizrt\viz3, which usually resolves to C:\ProgramData\vizrt\viz3. This folder is referenced as <viz data folder> throughout this Administrator Guide, and contains, for example:

- Viz Config files
- Script plug-ins
- Crash dump files

Temporary files are located at: %TMP%\vizrt\viz3, which usually resolves to C:\Users\<user name>\AppData\Local\Temp\vizrt\Viz3. This folder is referenced as <viz temp folder> throughout this User Guide.

Script Plug-ins are located in the <viz data folder>\ScriptPlugins subfolder.

Note: Script Plug-in files that already exist from a previous installation are automatically copied on install time if the installation folder did not change. If Viz Engine/Artist is installed in a different installation folder then Script Plug-in files must be manually copied from the old installation folder to <viz data folder>\ScriptPlugins.

4.3 Supported Software

4.3.1 Viz Engine Software

To run Viz Engine as a program or preview (optional) machine, the following software and configuration is needed:

Viz Engine specifications

Category	Requirement
Software	<ul style="list-style-type: none"> Installation of latest Viz Engine/Artist package Optional: (Additional plug-in packages like DataPool or Viz World Client) Optional: Viz Engine must be installed with an MPEG-4 codec and Matroska splitter when used for local preview of video clips from Viz One Codemeter runtime for WIBU based licensing
Hardware	License dongle for legacy hardlock licensing or valid Codemeter license Supported GPU and videoboard
Executable(s)	viz.exe
Ports and Connections	<ul style="list-style-type: none"> 6100: Preview and playout 14300: Viz Multiplexer 50007-50010: Multiplexing
Network access	<ul style="list-style-type: none"> Mapped drive to VOS still store folder Local preview: Mapped drive to Viz Engine data root

4.3.2 Preview Server

The Preview Server option is used in situations where Viz Engine is used to provide frames for snapshot or thumbnail generation. A typical use case would be to connect multiple Newsroom Components to a preview server.

The Preview Server must be installed on a separate Viz Engine machine with its own license.

Category	Requirement
Software	<ul style="list-style-type: none"> Latest Preview Server package Microsoft .NET Framework 4 Latest Viz Artist/Engine package Codemeter runtime for WIBU based licensing
Hardware	License dongle for legacy hardlock licensing or Codemeter license Supported GPU and videoboard

Category	Requirement
Executable(s)	PreviewServer.exe
Ports and Connections	54000: Used to connect over HTTP with the REST interface.
Network access	Uses the ZeroConf protocol to announce available services.

4.3.3 Viz Artist Software

The Viz Artist design machine should preferably have the same specifications as the Viz Engine playout renderer, especially if the designers need to test performance issues on demanding scenes.

If designers are creating templates for Viz Pilot, it is recommended that Viz Pilot is installed on a separate machine for more accurate playout emulation on Viz Engine.

4.4 Ports And Connections

This section contains information on the following topics:

- [Port Numbers](#)
- [Multiplexing Ports](#)

4.4.1 Port Numbers

The table below lists all default server and listening port numbers that are used. When the firewall is well configured it can be kept enabled. Client side firewalls may cause issues when the Viz Engine/Artist version is below 3.8.2 or the Graphic Hub version is below 3.0.0, since the communication protocol used was two-way and requires the firewall on the client side to be open for the Artist/Engine processes. However, it is not required to disable the firewall completely.

Listener	Port(s)	Descriptions and comments
Mediaftp	21	Used for video transfers from Viz One to Viz Engine.
Viz One	22	TCP and UDP for logging in to the Viz One operating system (Service: SSH).
Viz World Server	102 103	102 (TCP) is a Viz World Server listener port for Viz World Client connections when Server Allocator is not in use or only has one Viz World Server running. 103 (TCP) is a Viz World Server listener port for configuration tool connections to the first Viz World Server instance (as configurations are controlled by the first server instance). See also Vizrt Maps.

Listener	Port(s)	Descriptions and comments
Viz One	137 139	Used for SMB file sharing (Service: Netbios)
Viz One, Microsoft Bing and Imagery on Demand	80 8080	Web interface and client software. SOAP port for communication with Viz One. For download of Microsoft Bing and Imagery on Demand images (Service: HTTP).
OpenSLP	427	Service Location Protocol (SLP) based discovery and search (TCP, UDP).
Viz One	443 445	(Service: HTTPS) TCP and UDP used for SMB file sharing (Service: Microsoft-DS).
Viz One Delivery	554	Real-time Streaming Protocol (Service: TCP).
Oracle database	1521	For clients that connect to the Viz Pilot Database.
Sentinel HASP Run-time Environment	1947	The Sentinel HASP Run-time Environment uses port 1947 to communicate with local and remote components. This relates to Hardlock dongles used with Viz Curious Maps.
Viz One	3080	Low resolution video and index files (Service: lighttpd).



Listener	Port(s)	Descriptions and comments
Video servers	5250	MVCP and Xlator control port for video servers. <div style="border: 1px solid orange; padding: 5px; margin-top: 10px;"> <p> Note: This port is only necessary in combination with the video server extension (Service: AVCP).</p> </div>
Viz Engine	6100 6700 6800 55001-55016 56000-56007	Communication ports used by Control Applications (like Media Sequencer) to connect to a Viz Engine program and/or preview channel. Viz Engine's default program and preview port is 6100. <p>In a single channel configuration where both program and preview output is on the same machine, the default preview port is set to 6800 to separate the program and preview channels.</p> <p>In a dual channel configuration, the default program ports are 6100 and 6800 for channel one and channel two, respectively.</p> <p>In a dual channel configuration, when used for stereo production, the default program ports are 6700 and 6800 for channel one (left eye) and channel two (right eye), respectively.</p> <p>For controlling Graphics Channels and/or Superchannels, ports 55000-550016 and 56000-56007 are used (can be changed in the config).</p>
Viz Trio	6200 6210	6200 is used for controlling the Viz Trio client over a socket connection. 6210 is used by the Graphics Plug-in to establish a connection to Viz Trio.
Newsroom Component	6220	Used by the Graphics Plug-in to establish a connection to Viz Pilot's Newsroom client.
Graphics Plugin Editor	6230	Used by the Graphics Plug-in to establish a connection to the Graphics Plug-in Editor (on Mac).
Graphics Plugin Config	6240	Used by the Graphics Plug-in to establish a connection to the Graphics Plug-in Configuration tool (on Mac).

Listener	Port(s)	Descriptions and comments
Ticker Service	6300	Ticker handler in the Media Sequencer connects to port 6300 for feedback from Ticker Service.
	6301	Ticker handler in the Media Sequencer connect to port 6301 when controlling the ticker via a socket connection.
Viz Pilot	6484	Socket connection used for controlling Viz Pilot using macro commands.
Viz One	6555	Message bus port for communication with Viz One (Service: Message bus).
Preview License server	7452	For the Newsroom Component using an unlicensed Viz Engine for local preview with a connection to the Preview License server (is not the same as the Preview Server).
Viz Pilot Data Server	8177	Used to connect over HTTP with the REST interface.
Media Sequencer	8580	For clients connecting to the Media Sequencer. 8580 is specifically used to connect over HTTP with the REST interface.
	8594	
Viz One	8080	Used for sending key frames (Service: ardok).
Gateway	10001	For DB notification events.For Gateway controller clients. For MOS object updates.For MOS playlist updates.
	10002	
	10540	
	10541	

Listener	Port(s)	Descriptions and comments
Viz World Server	10100 10200	<p>10100 (TCP) is a Server Allocator listener port for Viz World Client connections, and is only used in order for clients to get connection details about Viz World Server(s). The first client connection is always diverted to port 102. In case of multiple server instances, port numbers are assigned according to a predefined schema (i.e. 10101, 10102 for server instance two and three and so on). In case there is no Server Allocator, Viz World Server itself switches to port 102.</p> <p>10100 (UDP) is a Viz World Server listener port for Server Allocator communication.</p> <p>10200 (UDP) is a Server Allocator listener port for Viz World Server communication. Both UDP ports are internal ports used between the servers. For more information, please see the Viz World Client and Server 11.1 User Guide and later. See also Vizrt Maps.</p>
Viz Pilot	10640	Used by Gateway to establish a connection to Viz Pilot in order to send and receive updates on MOS messages (e.g. items and playlists).
Viz Engine	14300	Alternative port used to avoid conflicts with port 6100 (e.g. when using Viz Multiplexer). Port 6100 is normally used by renderers that are On Air, hence, it is (e.g. when running Viz Pilot version 4 or Graphics Plugin towards Viz Artist/Engine 2.x) recommended to use another port. Port 14300 is an optional port. The default 6100 may also be used if the renderer is not used On Air.
Graphic Hub	19396-19398	Ports in use when connecting to different Graphic Hub components. Since Graphic Hub 3.0.0 and Viz Engine/Artist 3.8.2 a limited number of open network ports is required. These do not require any port exemption rules on the client side firewall configuration. However, for earlier versions, all ports must be open on the client side.
Connection Broker	21098	Connection to the Connection Broker configuration interface (e.g. http://localhost:21098/).
Viz Engine	50007 - 50009	Multiplexing Ports that enable Viz Engine to work on other scenes in sessions that are used for preview purposes.
	50007	MUX Isolated port: All connections to this port get its own session.
	50008	MUX Shared port: All connections from one single host shares one session.

Listener	Port(s)	Descriptions and comments
	50009	MUX Fixed port: Same as shared port except that allocated resources are never cleared from memory.
	50010	Still Preview port: Enables a user to request a preview of the next scene to be put On Air while another scene is On Air.
Preview Server	54000	Used to connect over HTTP with the REST interface.
Codometer Webinterface	22352	To configure the Codemeter runtime via WebInterface.

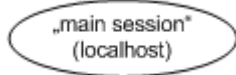
4.4.2 Multiplexing Ports

Ports	Viz Engine
All other ports	
Still Preview Port	
MUX Isolated Port MUX Shared Port MUX Fixed Port	

The multiplexer functionality is an integral part of Viz Engine. When using Viz Engine a session management takes place internally, with one default session for the GUI and internal/external commands, and additional sessions created on-demand for the multiplexing ports or the preview port.

With multiplex ports, other than the MUX Still Preview port, the Viz Engine state is only switched when a command is received, which means a new session is created; hence, ten consecutive commands from a client only results in one state switch on the first command.

- The MUX Still Preview Port (50010) state is switched when a command is received and immediately switched back to the main session such that On Air rendering is not hindered in any way.
- The MUX Fixed Port (50009) is traditionally used by the old Viz Pilot Newsroom Client, and is the same as the MUX Shared Port, except that allocated resources are never cleared from

memory. To avoid memory overload, it is recommended to clean up the Viz Engine regularly when this port is used.

Info: There is no automated cleanup of memory on this port.

- The MUX Shared Port (50008) is a shared port where all connections from one single host shares one session. It is most often used by Viz Trio and the Newsroom Client to show preview frames.
- The MUX Isolated Port (50009) is an isolated port where all connections get their own session. It is used, for example in an NLE configuration, to deliver frames to the host NLE-system when rendering or scrubbing video clips with graphics. Using this port also suppresses bounding box commands.

All multiplexing ports are supported by all Viz Engine versions, but require a license.

4.5 User Account Control

Since version 3.7.1, Viz Engine/Artist is UAC aware. This means Viz Artist/Engine can run when UAC is enabled on the computer.

IMPORTANT! UAC configuration is the responsibility of the individual company's own IT policy.

When UAC is enabled, an additional confirmation prompt shows when these items are installed or removed:

- Viz Artist/Engine
- Viz One Services (Mediaftp or fsmon)
- The web service for the [Viz Engine REST interface](#)

When UAC settings are modified, a reboot is required. Viz Artist/Engine and all plug-ins shipped with the Viz Artist installer are UAC aware. However, if other plug-ins are used, a warning message may be displayed during Viz Engine startup:

WARNING: The plug-in *<plugin-name>.vip* may not be UAC aware. Contact your plug-in vendor for an updated version.

This warning means that the plug-in may not work correctly if UAC is enabled. For example, the plug-in might attempt to write into the installation folder, which is not allowed anymore. Contact the plug-in vendor for information on the UAC awareness of the plug-in.

IMPORTANT! Even though the warning shows, the plug-in is still loaded on startup.

Most changes result from the UAC requirement that an application must not write into the installation folder.

4.6 Viz Artist And Engine Installation

Use the Viz Artist Bundle Installer to install both Viz Artist and Viz Engine. The bundle installer contains Viz Artist, Viz Engine, the license dongle drivers (Codemeter and legacy Hardlock), and all required dependencies.

This section covers the following topics:

- [Installing Viz Artist and Engine](#)
- [Upgrading from a Previous Installation](#)
- [To Change or Reinstall an Existing Installation](#)
- [Silent Installation of Viz Artist and Engine](#)
- [To Identify Installed Architecture and Version](#)

The software package is available in 32-bit and 64-bit versions. Most modern PCs should run the 64-bit version. Install the 32-bit version only if required (e.g. for missing codecs).

The file name of the bundle installer indicates the architecture and software version in the following pattern: *Name-Architecture-Major.Minor.Maintenance.Build*

Where architecture can be either **x64** or **x86**. By common convention, x64 signifies the 64-bit version, and x86 signifies the 32-bit version.

Example: The file *VizArtistBundle-x64-3.13.0.99999.exe* is the bundle installer for Viz Artist and Engine version 3.13, for 64-bit architecture platforms.

4.6.1 Installing Viz Artist and Engine

Installation of Viz Artist and Engine requires elevated permissions on the destination computer. Make sure to log on to the computer with either an administrator account or a user account with elevated rights, before installing the software. See [Running Viz Engine and Viz Artist without administrator rights](#) for further details. If you install Viz Artist on a non-supported operating system platform, you get a warning message.

Before installing the software, make sure to:

- Check that your computer meets the [Prerequisites](#) for hardware and system configuration.
- Decide which of the [Viz Artist and Engine Platforms](#) is suitable for your installation.
- If upgrading, familiarize yourself with the information in the [Upgrading from a previous installation section](#).

Tip: Download the Viz Artist and Engine installer from Vizrt's FTP server.

1. Run the installer. The bundle installer provides an overview of all required dependencies that need to be installed in addition to the main application. Already installed dependencies are

listed as **Installed**. You can collapse the selection list by clicking **Settings**.

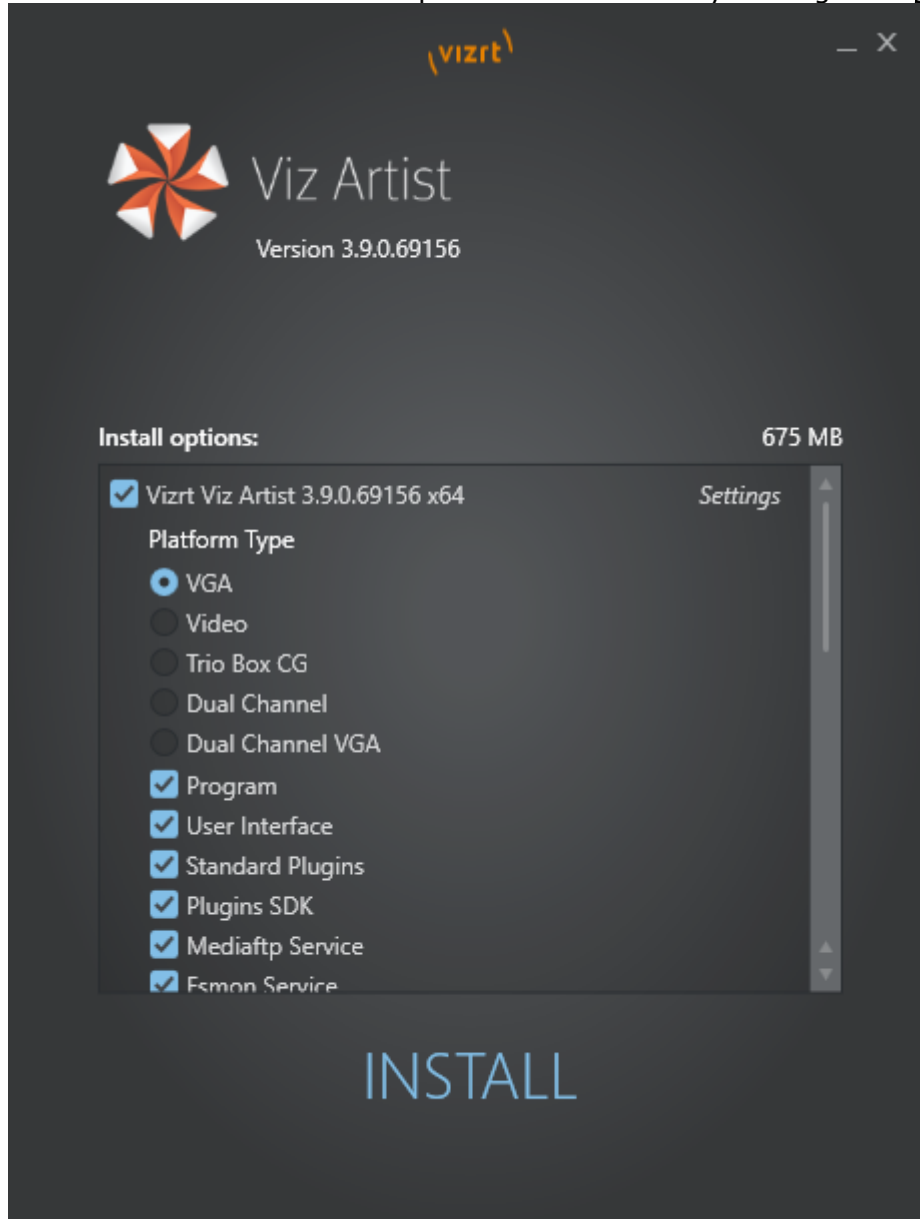

Note: The bundle installer selects most features by default. Check the feature list and add or remove features as required.

2. Scroll further down to select a custom installation location, if required.

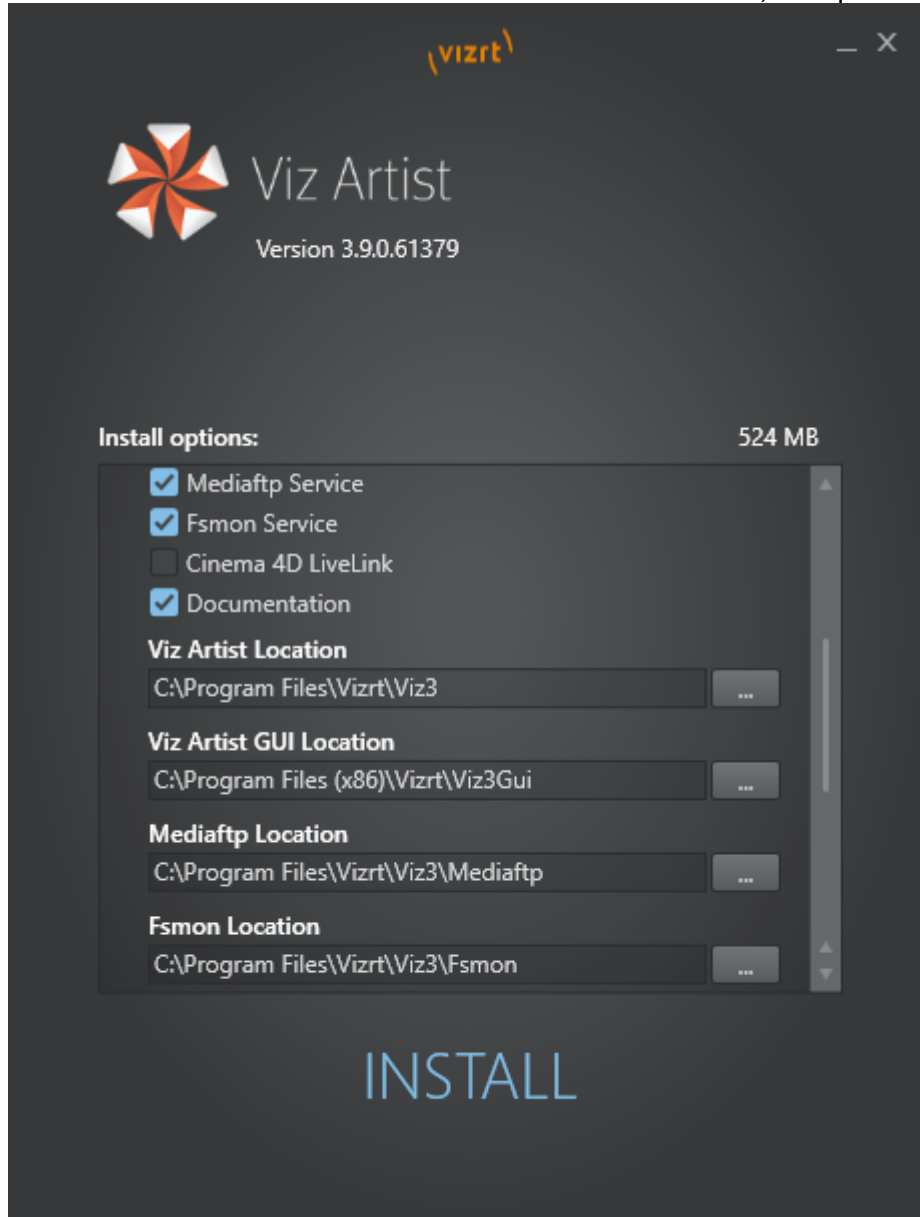

3. Click install to complete the installation wizard. The various dependencies are installed as required.
4. Click **Finish**. If something interrupts the installation, click **Show log** to view the installation log files.

4.6.2 Upgrading from a Previous Installation

When you upgrade an existing installation to a new version of Viz Artist and Engine, observe the following:

- If upgrading an existing installation with the *VizArtist.msi* installation file, you see this message: *"Viz Artist 32bit is already installed. Remove the existing installation first, then*

restart the installer.” Open **Uninstall a program** from the Control Panel, select Viz Artist and remove the existing installation. Then run the MSI file to install Viz Artist/Engine.

- Installing Viz Artist/Engine using the bundle installer upgrades older installations. Any older version is removed, except versions prior to Viz Artist and Engine 3.6. This is true even if you opt to install Viz Artist/Engine in a different directory.
- You can only install one version of Viz Artist/Engine per architecture. This means:
 - You cannot install Viz Artist and Engine in parallel with older versions.
 - You can install a 32-bit version and a 64-bit version of Viz Artist/Engine in parallel.
 - Installing the 64-bit version does not upgrade any existing 32-bit version, and vice versa.
- The installer suggests installing to the previous installation folder. You may change it. The recommended installation directories are *C:\Program Files (x86)\vizrt\Viz3* for the 32-bit application and *C:\Program Files\vizrt\Viz3* for the 64-bit application.
- The installer pre-selects all previously installed features. You may change them.
- The installer does not support downgrading. Remove the currently installed version to install an earlier version of Viz Artist and Engine.
- Upgrading does not change any modified or newly added files of the old installation. For example, files like Configuration files, Log files or additional files like customer plug-ins, remain unchanged in their original folder.
- Since Viz version 3.7.1, *viz.exe* no longer checks the *%Program Files%* folder for Configuration files (*.cfg*) or Lens files (*.lcb*). These files must be located in *%ProgramData%\vizrt\viz3*.
 - If the previous Viz Engine/Artist was installed in the default folder, the Configuration and Lens files are automatically copied during upgrade from the default installation folder to *%ProgramData%\vizrt\viz3*.
 - If the previous Viz Engine/Artist was installed in a custom folder, the Configuration and Lens files needs to be copied manually from the old installation folder to *%ProgramData%\vizrt\viz3*.

4.6.3 To Change or Reinstall an Existing Installation

Use the Viz Artist bundle installer to change or reinstall an existing installation. The installer pre-selects any already installed features. Check the boxes for the components that you want to add or remove, then click **INSTALL**. This reinstalls the complete software suite, repairing any damaged or accidentally deleted files.

4.6.4 Silent Installation of Viz Artist and Engine

The bundle installer does not support silent installation, which requires that you install each package separately. Extract all packages from the bundle by adding the */dump* command line option.

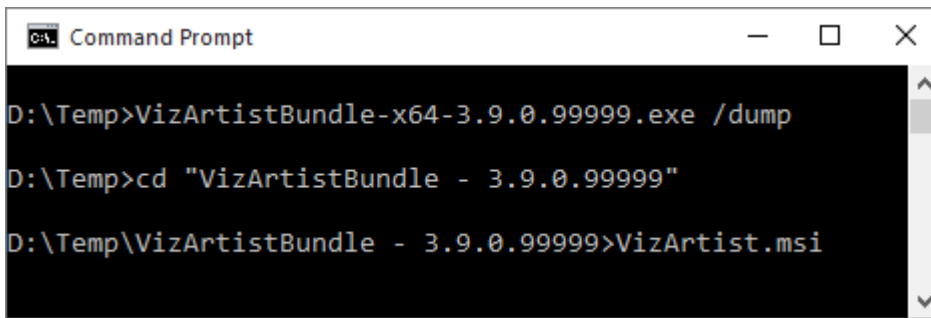

```

C:\> Command Prompt
D:\Temp>VizArtistBundle-x64-3.9.0.99999.exe /dump
D:\Temp>cd "VizArtistBundle - 3.9.0.99999"
D:\Temp\VizArtistBundle - 3.9.0.99999>VizArtist.msi

```

This creates a sub-folder containing all packages contained in the bundle installer. Use the *VizArtist.msi* file located in this sub-folder for unattended installations. This is useful in large-scale enterprise deployment.

IMPORTANT! The *VizArtist.msi* installation file does not support upgrades, and terminates without installing. Enable logging and specify a log file to keep track of any issues during silent installation.

IMPORTANT! The *VizArtist.msi* installation must be done within an Administrator console.

1. Run the following from a command line prompt, or save it to a batch file for execution:

```

@rem silent installation
@rem platformtype: standardpc, video, trioboxcg, dualchannel
msiexec.exe /i <msi\_package> /quiet PLATFORMTYPE=<platformtype>

```

2. Enter `msiexec` on the command line and press enter to see other options. Common options are:

- **/i**: Installs or configures a product. Package: Specifies the name of the Windows Installer package file. ProductCode: Specifies the globally unique identifier (GUID) of the Windows Installer package.
- **/x**: Removes a product. Package: Name of the Windows Installer package file. ProductCode: Globally unique identifier (GUID) of the Windows Installer package.
- **/l, /log**: Enables logging. Make sure to specify the log file name.

Example: `msiexec /i VizArtist.3.13.0.99999_32bit.msi /norestart /passive PLATFORMTYPE=standardpc -lv installation.log`

4.6.5 To Identify Installed Architecture and Version

To check if Viz Artist is a 32-bit or 64-bit installation, click on the **Show License Information** button:

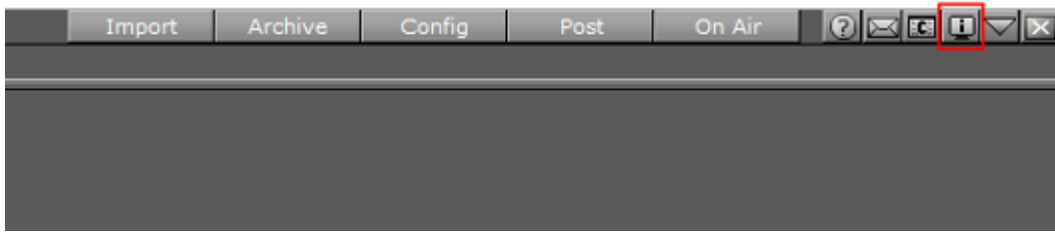

In the License Information window, the platform and Viz version number show as:

- **Platform:** Win32 (32-bit) or X64 (64-bit).
- **Viz Version:** 3.13.XX.XXXXX (Win32) or (X64).

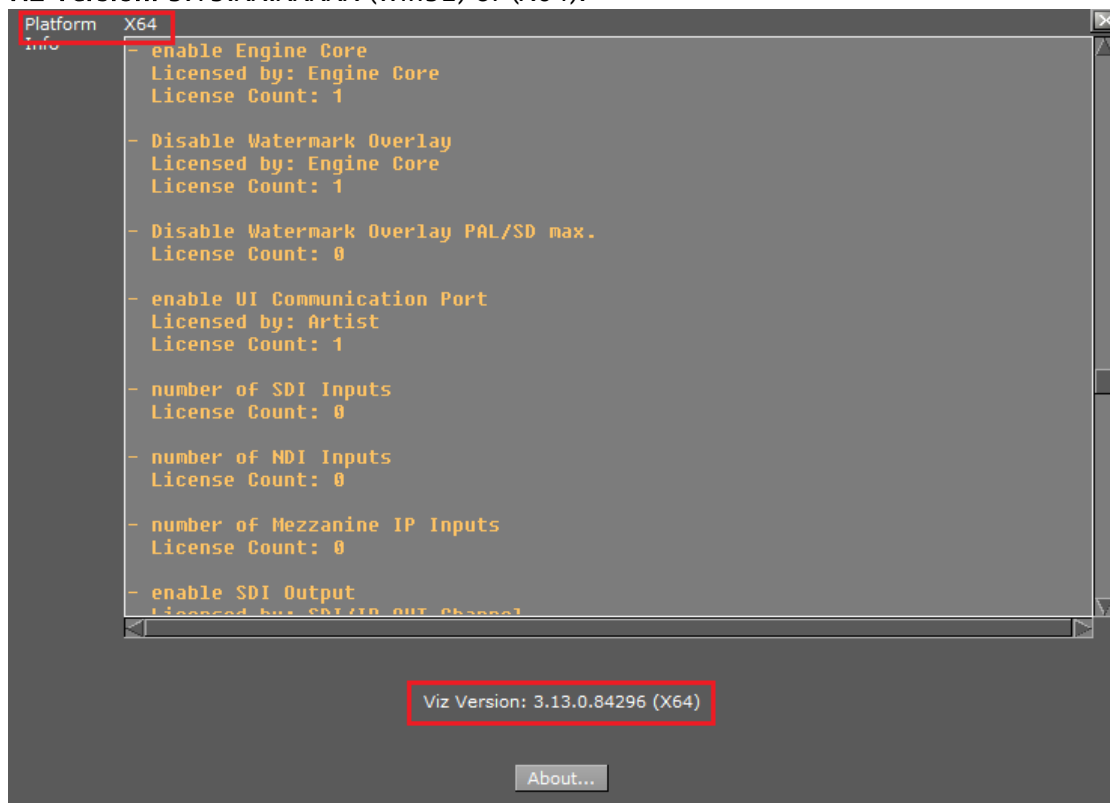

4.7 Viz Artist And Engine Platforms

Viz Artist/Engine can be installed and configured to use five different platforms. When Viz Artist/Engine is installed select which platform is required.

When Viz Trio One Box or Dual Channel versions are installed (with two GPUs), the Control GPU and Output GPU are selected by default. If required, Viz Artist/Engine runs on one GPU only. The Control GPU must have a display connected and is used for Artist/Preview.

The supported platform version options are:

Platform	Description
VGA	VGA is Viz Engine with VGA/DVI preview capabilities. This option has no support for any video hardware and has no live input or output options. This configuration can, for example, be used for a Video Wall solution, Viz Frame Servers (for Viz NLE and Viz Pilot preview/still rendering systems).
Video	The Video option supports live input and output on SDI and/or IP, and typically provides one program output (fill and key on one channel). Preview without live video is available through VGA/DVI.
Trio Box CG	Trio Box CG (Character Generator) is a Video version with, typically, one program and one preview output (fill and key on two channels). To support program and preview output this option supports two graphics cards (see Trio Box CG Mode).
Dual Channel	Dual Channel is a Video version with, typically, two program outputs (fill and key on two channels). To support two program outputs this option supports two graphics cards (see Dual Channel Mode).
Dual Channel VGA	Dual Channel VGA is a Dual Channel version with additional VGA/DVI preview capabilities.

4.8 Install The Legacy Hardlock Based Viz License

Viz Artist/Engine must have a license to operate. A license is normally acquired when the product is purchased. To get additional or updated licenses, contact your local Vizrt representative.

To configure a Viz Engine running on the new WIBU Licensing, please refer to [Viz License Configuration](#).

 **Note:** Some of the installed plug-ins are licensed separately.

4.8.1 To Apply a Viz License in the GUI

Use this procedure to apply a first time license, apply a new license after a license expiry, or apply a new license before a license expires.

1. Make sure that the date and time on the computer is correct. The license is only valid for a certain time frame.
2. Insert the License dongle.
3. Start Viz Engine or Viz Artist.
4. Open the License window:
 - If this is a first time license application or the license has expired, the License window opens.

- If this is a new license application before a license expiry date, click on the License Information button.

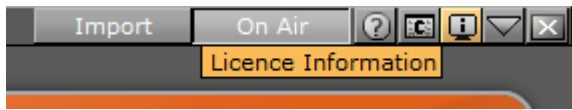

5. Check that the **Dongle ID**, in the License Information text file, is the same as the **System ID** in the License window.

LICENSE INFORMATION

Dongle-ID: 8f fb fe 54 ab 04 01 70

License: F6 67 AB 8D D0 05 AD 94 52 9E ED F0 34 AF 11 FF 24 A2 18

6. Check these details:
 - Check that the license string has 32 pairs of characters and that they are divided by a single space.
 - Check the characters and for spaces at the end.
7. Copy the license string from the License Information text file.
8. Paste the license string in the **License field** of the License window.
 - Check that the license key has not been entered twice.
 - Check that the whole string is pasted.
9. Click **Apply New License**.
10. Restart for the changes to take effect.

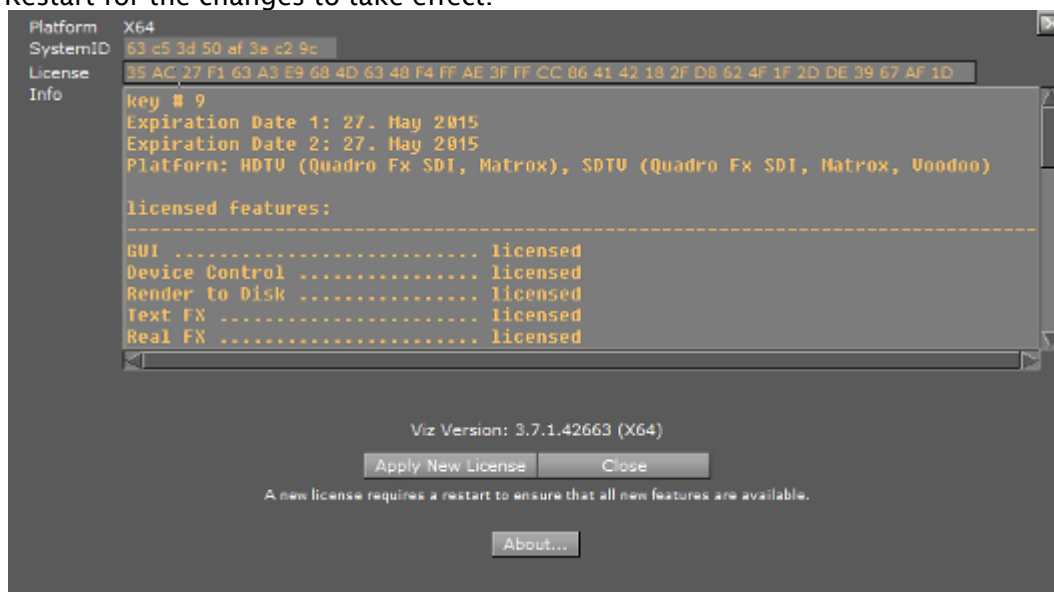

4.8.2 To Apply a Viz License in Viz Configuration

Use this procedure to apply new license before a license expires.

1. Make sure that the date and time on the computer is correct. The license is only valid for a certain time frame.
2. Insert the License dongle.
3. Open **Viz Configuration**.
4. Click on **Viz License Information**.

5. Check that the Dongle ID, in the License Information text file, is the same as the System ID in the Viz License Information panel.

LICENSE INFORMATION

Dongle-ID: 8f fb fe 54 ab 04 01 70

License: F6 67 AB 8D D0 05 AD 94 52 9E ED F0 34 AF 11 FF 24 A2 18

6. Check these License details:
 - Check that the license string has 32 pairs of characters and that they are divided by a single space.
 - Check the characters and for spaces at the end.
7. Copy the license string from the License Information text file.
8. Paste the license string in the **License** field of the Viz License Information panel.
 - Check that the license key has not been entered twice.
 - Check that the whole string is pasted.
9. Press **ENTER**.
10. Click **Save**.
11. Restart for the changes to take effect.

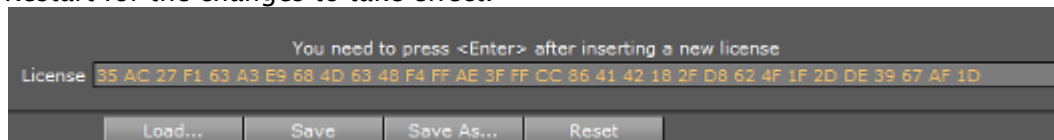

4.8.3 To Apply a Viz License with the Viz Console

Use this procedure to apply new license before a license expires.

1. Make sure that the date and time on the computer is correct. The license is only valid for a certain time frame.
2. Insert the License dongle.
3. Start Viz Engine, Viz Artist or Viz Config.
4. In the Viz Console enter the text `send KEY SET [full license string]`.

✓ **Tip:** In Viz Artist or Viz Engine, click on  to view the Viz console.

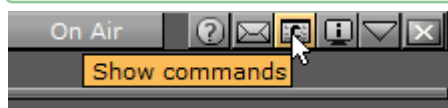

5. Press **ENTER**.
6. Restart Viz Artist/Engine for the changes to take effect.

4.9 EVS Video Server Control

An EVS Control Plug-in lets the Viz Engine control an EVS video server (like a tape deck over RS422). This gives Viz Engine the ability to load and control playback of EVS video server clips.

This section contains information on the following topics:

- [Setup Requirements](#)
- [RS422 and XtenDD35 Configuration](#)

- [RS422 Pin-out for the Connector Cable](#)
- [RS422 Controller Set Up Examples](#)
- [Bluestorm LP PCI card configuration](#)
- [ExSys EX-1303 USB to RS422 Connector Configuration](#)

4.9.1 Setup Requirements

- The computer which runs the Viz Engine must be equipped with an RS422 controller that maps the controller ports to the Windows COM ports.
- The RS422 port must be connected to an RS422 remote controller port of the EVS video server.
- The EVS player, controlled by the RS422 port, must be set up to use the protocol *XtenDD35* (No other protocol is currently supported).

4.9.2 RS422 and XtenDD35 Configuration

1. You need a RS422 controller that installs the RS422 port as a new COM port in Windows.
2. Set up the *XtenDD35* protocol on the used remote port of the EVS video server.

⚠ IMPORTANT! This must be done before an attempt to connect.

3. Manually set the Windows COM port settings to:
 - 38400 baud
 - 8 bytes
 - one stop bit
 - odd parity

⚠ IMPORTANT! This must be set before Viz Artist is started.

4. Usually, a special RS422 cable is required to connect the controller to the EVS video server. It is recommended to use a connector cable to connect the RS422/DB9 connector to a standard RS422 cable. The RS422 cable should work with a normal EVS video server controller.
5. Every RS422 controller has a different pin-out setting and requires a different connector cable. The table below shows which signal of the RS422 controller must be connected to which pin on the EVS side:

4.9.3 RS422 Pin-out for the Connector Cable

Signal type of RS422 controller	Cable pin on EVS side
RxD B+ (in)	7
TxD B+ (out)	3
TxD A- (out)	8

Signal type of RS422 controller	Cable pin on EVS side
RxD A- (in)	2
Sig Ref / Gnd	1

4.9.4 RS422 Controller Set Up Examples

The connection of a RS422 controller to the EVS is always different for each controller. Here are two examples:

4.9.5 Bluestorm LP PCI card configuration

Viz Engine side (Bluestorm LP card)		EVS side	
Signal type	Pin	Pin	Signal type
TxD+	2	3	RxD+
TxD-	3	8	RxD-
RxD-	4	2	TxD-
RxD+	1	7	TxD+
Sig Ref	5	1	Sig Ref

4.9.6 ExSys EX-1303 USB to RS422 Connector Configuration

Viz Engine side (ExSys EX-1303)		EVS side	
Signal type	Pin	Pin	Signal type
TxD+	2	3	RxD+
TxD-	1	8	RxD-
RxD-	4	2	TxD-
RxD+	3	7	TxD+
Sig Ref	5	1	Sig Ref

4.10 Dual Channel Mode

This section details how to configure the Dual Channel platform of Viz Artist/Engine (see [Viz Artist and Engine Platforms](#)).

Dual Channel is a video version with, typically, **two program** outputs (fill and key on two channels). To support two program outputs this option requires two graphics cards.

Once installed and configured, open the two Viz Engine consoles and add commands as required, or use an external application (for example Viz Trio or Viz Pilot) to control the Viz Engine.

4.10.1 To Configure Dual Channel

1. Install Viz Artist and select **Dual Channel** mode. Dual Channel installs and adds these icons to the desktop:

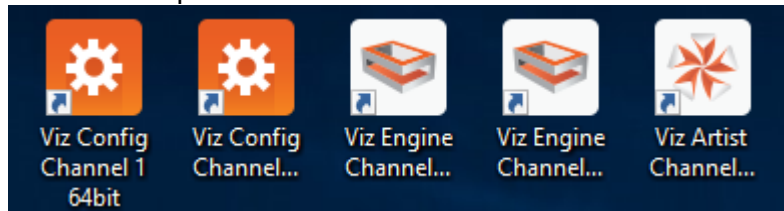

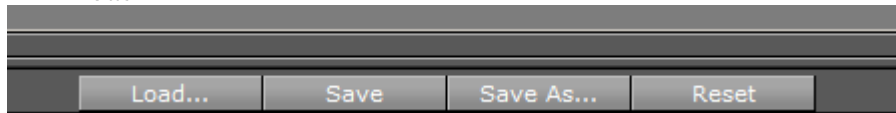
2. Open the **Viz Config Channel 1** application.
 3. In **Database**, set **Auto log in** to **Yes** (active).
 4. Click **Load...**
- 
- A screenshot of a software interface showing a row of buttons: 'Load...', 'Save', 'Save As...', and 'Reset'. The 'Load...' button is highlighted with a grey background.
5. Select `<viz install folder>/Configuration Profiles/dualchannel-0.cfg` and click **OK**.
 6. Configure Viz Artist/Engine as required, by setting the **Output Format**, etc. Then click **Save** and exit Viz Config.
 7. Open the **Viz Config Channel 2** application and repeat the above steps to configure the second channel, using the `dualchannel-1.cfg` configuration file.

Note: The setting `create_default_renderer = 1` should be set if Viz Engine is started in console mode (without any user interface).

See Also

- [Viz Trio User Guide](#)
- [Viz Pilot User Guide](#)

4.11 Trio Box CG Mode

This section details how to configure the Trio Box CG (Character Generator) platform of Viz Artist/Engine (see [Viz Artist and Engine Platforms](#)).

Trio Box CG mode is a video version with, typically, **one program** and **one preview** output (fill and key on two channels). To support program and preview output this option requires two graphics cards.

Once installed and configured, use Viz Trio to control the Viz Engines.

4.11.1 To Configure Trio Box CG

1. Install Viz Artist and select **Trio Box CG** mode. Trio Box CG installs and adds these icons to the desktop:

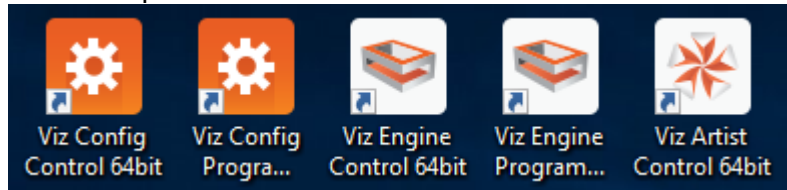

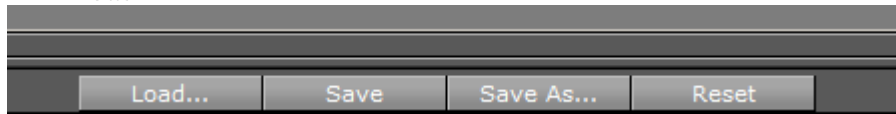
2. Open the **Viz Config Control** application.
 3. In **Database**, set **Auto log in** to **Yes** (active).
 4. Click **Load...**
- 
5. Select **<viz install folder>/Configuration Profiles/trioonebox-0.cfg** and click **OK**.
 6. Configure Viz Artist/Engine as required, by setting the **Output Format**, etc. Then click **Save** and exit Viz Config.
 7. Open the **Viz Config Program** application and repeat the above steps to configure the second channel, using the `trioonebox-1.cfg` configuration file.

Note: The setting `create_default_renderer = 1` should be set if Viz Engine is started in console mode (without any user interface).

4.12 Integration With Viz One

Viz Engine can be integrated with Viz One so that video clips can be transferred, and monitored, to and from Viz One. The following sections describe how to install the Transfer and Monitor services to the Viz Engine and how to enable clip payout.

A Viz One system, which is configured to communicate with the Viz Engine, must be running during the installation and configuration of the two services. Administrator rights are required to complete the install (see [Prerequisites](#)).

This section contains information on the following topics:

- [Configure Viz Engine](#)
 - [To Configure the Viz Engine](#)
- [Install Transfer and Monitor Services on Viz Engine](#)
 - [To Install the Transfer and Monitor Services](#)
 - [To Remove the Transfer and Monitor Services](#)
- [Configure Local Preview of Video Files](#)
 - [To Install Codecs for Local Preview](#)
 - [To Set a Preferred Decoder](#)
 - [To Register the Matroska Splitter](#)
 - [To Unregister the Matroska Splitter](#)
 - [To Configure Preview of Clips Stored on Viz One](#)

4.12.1 Configure Viz Engine

Viz Engine must be configured for the transfer and playing-out of video clips from Viz One.

To Configure the Viz Engine

1. Open **Viz Configuration**.
2. Click on **Output Format**.
3. Select the correct output format as used in Viz One.
4. Click on **Video Board**.
5. Set the **Viz Link** option to On.
6. Click on **Video Input**.
7. Make sure that at least one Clip Channel is active.
8. Click **Save**.
9. Restart Viz Engine.

4.12.2 Install Transfer and Monitor Services on Viz Engine

The **Mediaftp** (file transfer) and the **Fsmon** (file system monitor) Services are required for Viz One a Viz Engine to exchange data. Both services are part of the Viz Artist installation, but must be installed (activated) or removed (deactivated) through the Viz Configuration.

⚠ Note: If these Services are not required, make them unavailable when Viz Artist is installed. The Mediaftp Service prints some feedback to the Viz Engine Console. The Fsmon Service does not.

The files for Mediaftp and the Fsmon are installed into the folders:

- <viz install folder>\Fsmon
- <viz install folder>\Mediaftp

Log-files are written to the folders:

- <viz data folder>\Fsmon
- <viz data folder>\Mediaftp

To Install the Transfer and Monitor Services

⚠ IMPORTANT! Make sure that the Clip Data Directory is set correctly before the services are installed (see [Video Board](#)).

1. Open **Viz Config**.
2. Click on [Viz One](#).
3. In the **Days to keep log files** field, set the number of days log files are to be kept (default is seven days).



4. **Fsmon Service Only:**
 - a. Enter the host name of the local host.

- b. Enter the host name of the Viz One Message Queue Server.

IMPORTANT! The local host name must be exactly the same string that was entered in the Viz One as host name for the Viz Engine (it must be the exact same string as seen beside Host on the Servers page).

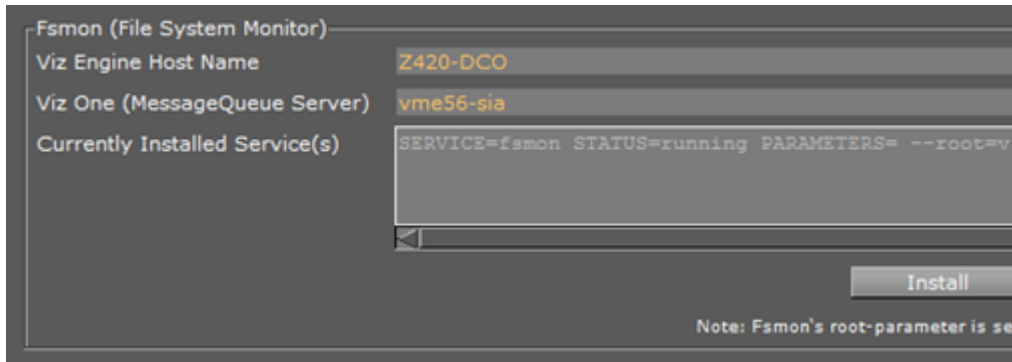

5. **MediaFTP** Service Only: Set the transfer bandwidth (Kbits per second), as required.

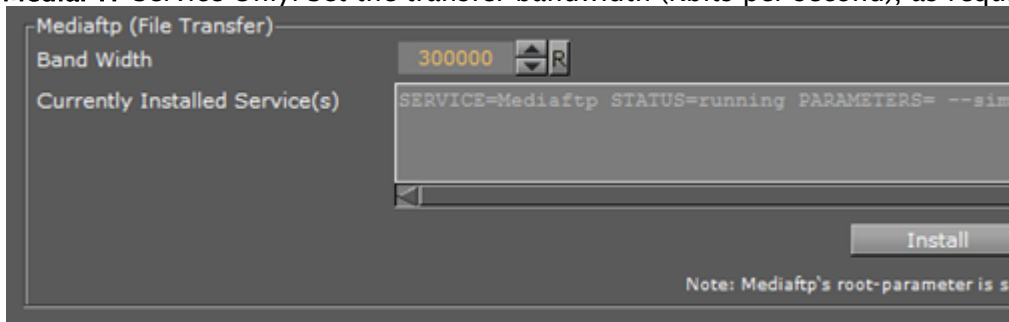

Note: Mediaftp is installed with the `-a` flag. This assumes that the default Viz One user/password combination is: `vtrsync/vtrsync`. Mediaftp installs, but does not work, if the user/password combination is different (see **Adding a Viz Engine** in the Viz One Administrators Guide).

6. Click on **Install** for each required Service.

Note: Any currently installed Services must be removed before a new Service can be installed.

To Remove the Transfer and Monitor Services

Note: When a Service is removed, the Service is made **inactive**. The Service is still available, and if required again, click **Install** to make **active**.

1. Open **Viz Config**.
2. Click on **Viz One**.
3. Click on **Uninstall** for each required Service.

4.12.3 Configure Local Preview of Video Files

If a Viz Engine is used for local preview (for example, Viz Engine installed on a control client machine) the FFDSHOW codec package and a Matroska splitter, must be installed.

Note: The procedures, detailed below, are only relevant for low resolution versions of video clips to be previewed on Viz One. In most cases this happens when control applications, such as Viz Trio, are used to, for example, preview a full screen clip. High resolution video clip versions do not need this codec installation.

To Install Codecs for Local Preview

After the FFDSHOW codec package has been installed:

- Make sure that Viz Engine or generally no applications are excluded (there is an inclusion and exclusion list in FFDSHOW)
- Make sure that there are no other codec packages installed on the machine that interfere with FFDSHOW or the Matroska splitter.

Note: A license is required for clip playback as FFDSHOW does not come with a decoding license.

1. Start the browser.
2. Search for and download:
 - The FFDSHOW MPEG-4 Video Decoder.
3. **Remove** older 64-bit versions of the MPEG-4 codec.
4. Extract:
 - The Matroska Splitter.
 - The Windows 7 DirectShow Filter Tweaker.
5. **Install** the **MPEG-4 codec**.
6. Set your **MPEG-4 32bit decoder** to **FFDSHOW**.
7. Register the Matroska Splitter.

IMPORTANT! Make sure a license is available to use the codec and that the 32-bit version of the codec is downloaded

To Set a Preferred Decoder

1. **Run** the Windows 7 DirectShow Filter Tweaker.

2. In the appearing dialog box click **Preferred decoders**.

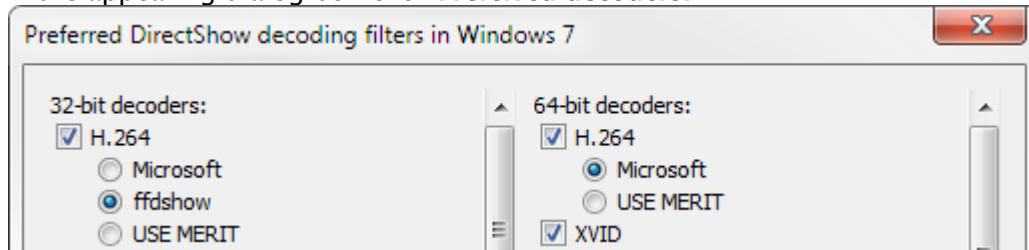

3. Set your **MPEG-4/H.264 32-bit decoder** to **FFDShow**.
4. Click **Apply** and **Close**.
5. Click **Exit**.

To Register the Matroska Splitter

1. Extract the **Matroska Splitter**.
2. Copy the **ax file** to your `C:\Windows\System32` folder.

Note: There are two files available, one in the root folder that is used for 32-bit systems, and one in the x64 folder used for 64-bit systems.

3. Click on **Start > Run**.

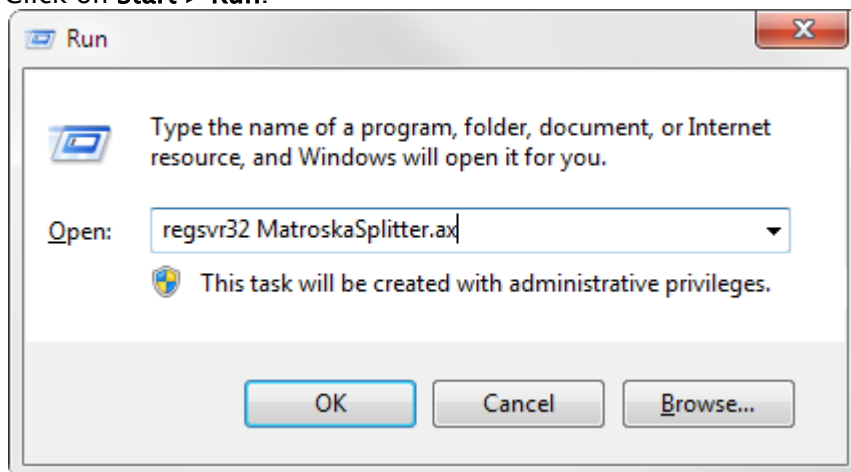

4. Enter **regsvr32 MatroskaSplitter.ax**.
5. Click **OK**. A message box appears confirming your registration.
6. Click **OK**.

To Unregister the Matroska Splitter

1. Click on **Start > Run**.
2. Enter `regsvr32 -u MatroskaSplitter.ax`.
3. Click **OK**. A message box appears confirming that it is unregistered.

To Configure Preview of Clips Stored on Viz One

If the **VGA version** is installed, do these steps:

1. Open Windows Explorer.

2. Open the **Viz Config** file.
3. Locate SECTION VIDEO.
4. Set `vizlink_mode = 1`.
5. **Save** the file. If the **Video version** is installed, do these steps:
 - a. Start Viz Config
 - b. Select the **Video Board** section and enable (On) the **Viz Link** option
 - c. Click **Save**.

See Also

- [Prerequisites](#)
- [Viz One Administrator Guide](#)

4.13 Viz Engine REST Interface

REST (short for Representational State Transfer) is an architectural paradigm for distributed systems, such as web services. Broadly spoken, REST relates to HTTP in the sense XML relates to HTML; a paradigm of the general concepts behind HTTP with some added restrictions. One such constraint is the statelessness of the communication; which HTTP violates via cookies. The most widely known application of REST, are web pages accessed via HTTP. Each web page is a unique resource, accessed via it's URL (Uniform Resource Locator) which can be operated on (for example GET /books/dune.html). This combination of operation and URL is called a message. In REST, a message has to be self-descriptive, meaning that all the information needed to process the message is required to be contained within the message.

The Viz Engine REST interface can be activated by enabling **Webservice** in the [Communication](#) section of [Configuring Viz](#).

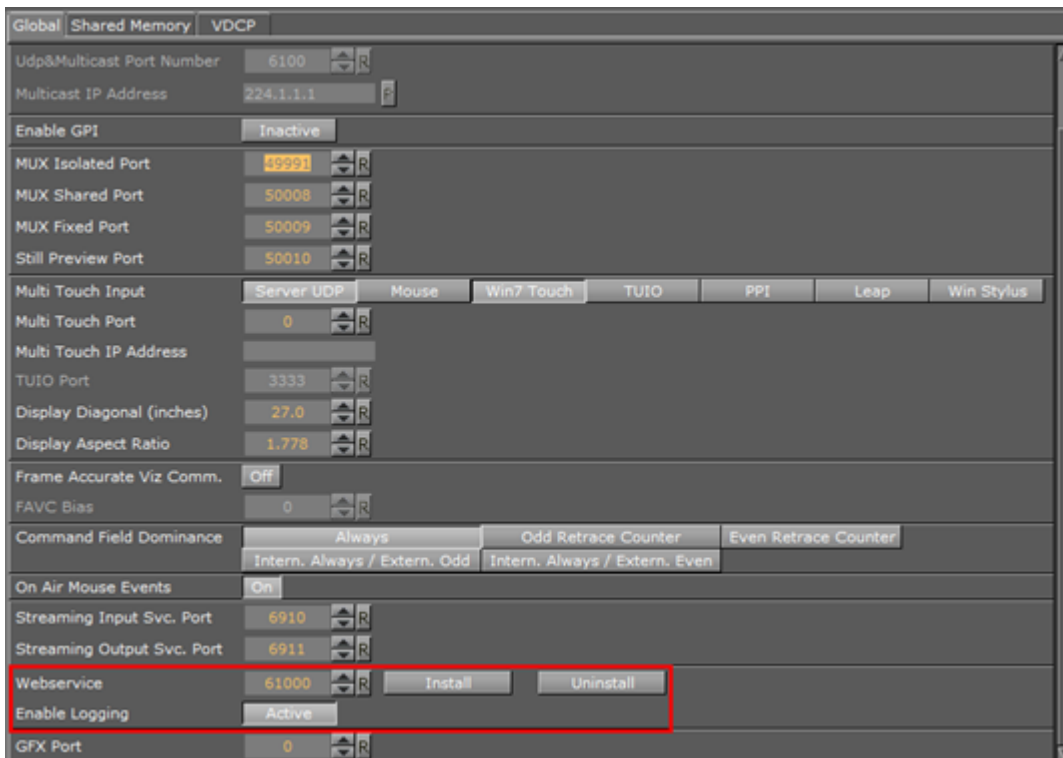

If [User Account Control](#) is active, press **Install** after setting the Port. The default port for the Viz Engine web service is 61000. After restarting Viz, the REST interface can be accessed by navigating a web browser to <http://localhost:61000>. The landing page displays the status of the Engine, with information on which mode it is running in and its version number.

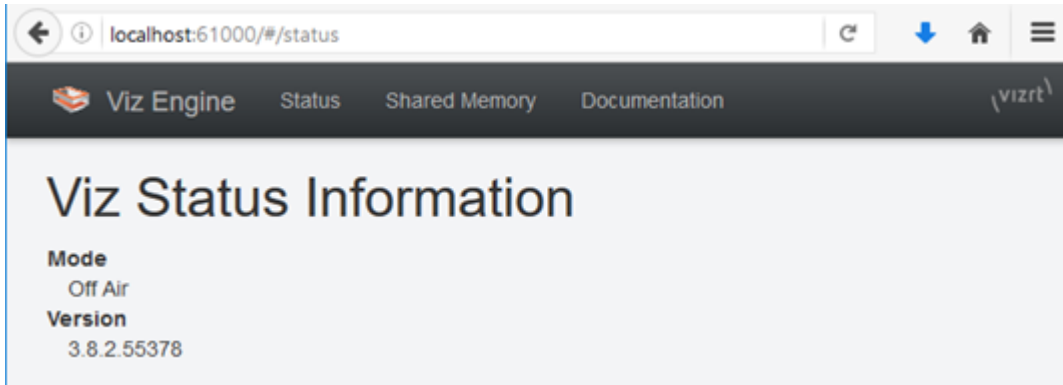

Once the REST interface has been activated, the complete documentation for the Viz Engine REST interface can be accessed by navigating to <http://localhost:61000/#/documentation>, or by clicking the **Documentation** link from the landing page.

4.14 Dolby E Support

Viz Engine is certified by Dolby for decoding Dolby E streams from the inputs into the Viz Engine, and encoding the first eight audio channels back to Dolby E on the output.

This section contains the following topics:

- [Dolby E Features](#)
 - [Dolby E License](#)
- [Dolby E Configuration](#)
 - [To Enable Dolby E Functionality](#)
 - [To Set Audio in Channels as Dolby E Inputs](#)
 - [To Enable Dolby E Encoding](#)

4.14.1 Dolby E Features

The Dolby E feature set in Viz Artist/ Engine is defined as follows:

- Dolby E is supported on Matrox Video I/O hardware only
- Dolby E is supported both as AES or embedded audio on the input and output side
- Decoding of one Dolby E stream (minimum eight/maximum 16 Dolby E channels) on all inputs.

⚠ Note: The Dolby E stream (encoded in a stereo pair) must be on the first two AES or embedded audio channels

- Encoding of one Dolby E stream (minimum eight/maximum 16 Dolby E channels) on the fill output.

Note: The Dolby E signal is encoded on the first two AES or embedded audio channels on the output.

- All audio channels from the Viz timeline can be mixed, as usual, with the decoded Dolby E signal from the inputs, and is output together with the input audio as Dolby E.
- Dolby E encoding and decoding can be configured independently, i.e. it is possible to input PCM audio and output Dolby E or vice versa.
- You can also have PCM audio on one or more inputs and Dolby E audio on different input and mix them together.
- Dolby E decoding from clip channels is **not** supported.

Dolby E License

Each Dolby E stream processed in the system requires a license and a physical Dolby-E dongle.

For example, if there are two input signals with Dolby E and the output is to deliver Dolby E as well, two decoder and one encoder licenses are required. The Dolby E licenses are software licenses which reside on a software dongle and can hold multiple licenses for one system.

4.14.2 Dolby E Configuration

This section details the setup required in the Viz Config file and GUI.

To Enable Dolby E Functionality

The Dolby E signal can be present in the embedded audio of the video signals, or on the AES inputs of the Matrox card.

1. Open the Viz Config file.
2. Set **DolbyEEnabled** to 1.

To Set Audio in Channels as Dolby E Inputs

The Dolby E stream must be present in the sub-channel 0 and sub-channel 1 of the input.

1. Open the Viz Config file.
2. Configure these settings as shown:
 - ChannelDolbyEEnabled__0 = 1
 - ChannelDolbyEEnabled__1 = 0
 - ChannelDolbyEEnabled__2 = 0
 - ChannelDolbyEEnabled__3 = 0
 - ChannelDolbyEEnabled__4 = 0
 - ChannelDolbyEEnabled__5 = 0
 - ChannelDolbyEEnabled__6 = 0
 - ChannelDolbyEEnabled__7 = 0

To Enable Dolby E Encoding

This enables the encoding of the first eight internal audio channels to a Dolby E stream which are sent to the output.

- Set **DolbyEOutput** to 1.

Note: Only live video inputs are supported.

4.15 Newtek NDI

Viz Engine fully supports the Newtek NDI protocol. This can be either done by using the native Newtek Integration or in combination with Matrox.

4.15.1 Newtek Only

To configure the Viz Engine using Newtek only:

- Install a video version of Viz Engine.
- Make sure any Video Board is disabled.
- Set the Software I/O Mode to **NewTek Tricaster**.
- Enable the number of stream inputs for your output system in the **Video Input** section.

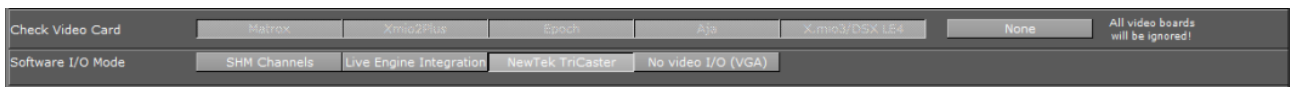

Once the engine has been configured and started, it discovers all available NDI sources within the network.

Note: Sources created after the Viz Engine has started are not available, as discovery currently only happens within the startup procedure.

Sources can be assigned by selecting a source in **Configuration > Video Input: Stream Input**.

Note: Audio is currently only fully supported on progressive formats.

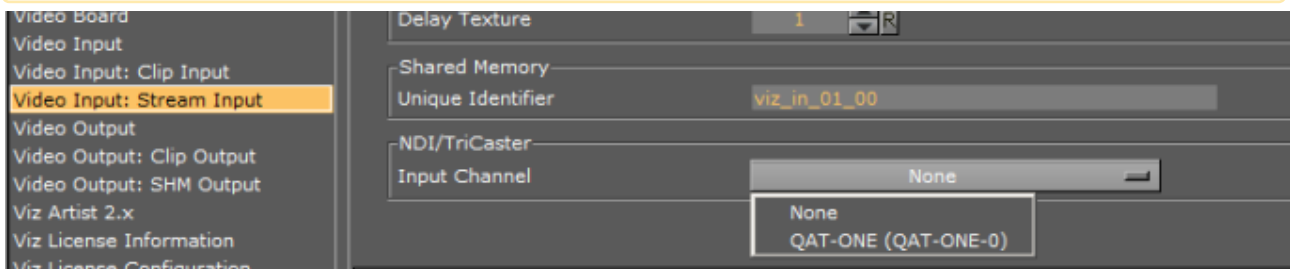

This NDI stream can be used afterwards as a regular stream input.

Note: If a source can not be discovered, install the NDI tools from Newtek and manually add the source by using the NDI Access Manager.

The output registers itself as NDI stream and the *machinename+instance*.

Note: The maximum number of inputs is limited by the network capabilities and the resolution. Usually two 1080p inputs on a dedicated network are realistic.

4.15.2 NDI in Combination with Matrox

To use NDI inputs and Matrox Output, you need to manually set the value for *stream_in_type* in the VIDEO section of the Viz Config file: `stream_in_type = 4`.

You should manually assign your sources, in this case (no GUI support) in Viz Config file: `StreamInXXX.NDISource = "SOURCE"` (e.g. `StreamIn1.NDISource = TESTMACHINE-Z8-W10 (FFMPEG)`, `StreamIn2.NDISource = TESTMACHINE-Z8-W10 (VLC)`).

Only inputs are supported, there is no additional NDI Output.

Note: The number of inputs available for usage is dependent on your network usage and bandwidth. In an ideal scenario, a dedicated network is favored.

Note: Each configured Input channel can directly affect performance, it is therefore advised to only activate the inputs to be used.

5 Hardware Related Information

- Note:** As a general recommendation for all hardware types:
- Disable all power saving options in Windows or in the BIOS Settings.
 - Disable Hibernate mode.
 - Disable Secure boot for driver installations (optional).

The installation of video, audio or graphics cards is not required on a new system. However, for maintenance or upgrades, it is important to know how to install the different models.

All machines ordered from Vizrt are pre-installed and do not require any changes.

Information on how to replace a Matrox X.mio board and connect an audio-extension card can be found in the [Matrox](#) chapter.

- IMPORTANT!** Be careful when handling cards, see [Handling and Installing Cards](#) for some advice.

5.1 Handling And Installing Cards

Static electricity from your body can damage your cards or your computer. Although you may not notice it, static electricity is generated every time you move. It's often too small to cause a spark, but it can still cause damage to sensitive electronic components or at least reduce their lifespan.

To avoid damage, please observe the following precautions:

- Do not remove cards from their anti-static bags until you're ready to install them. Before removing the cards, place the packages within easy reach of the area where you intend to perform the installation.
- You should avoid touching the chips and other components on the circuit boards. Try to handle the cards by their edges.
- Try to work in an area where the relative humidity is at least 50%.
- Do not wear wool or synthetic clothing. These fabrics tend to generate more static electricity than cotton, which is best for this kind of work.
- Turn off the power switches on your computer and its connected components.
- Once you've opened your computer, drain static electricity from your body by touching a bare metal surface on your computer chassis before you install or remove any parts of your system. If you have a grounding wrist strap, use it while handling and installing any components in your computer.

5.2 Graphics Boards

This section contains information on the following topics:

- [NVIDIA Driver Configuration](#)
- [Supported GPUs and Driver History](#)
- [Working with Two or More GPUs](#)

- [Working with Synchronous Output](#)

5.2.1 NVIDIA Driver Configuration

This section contains information on the following procedures:

- [To Configure NVIDIA Driver Settings for Viz Engine, Video mode](#)
- [To Configure NVIDIA Driver Settings for Viz Engine, VGA mode](#)
- [Vertical Sync](#)
- [To Configure Mosaic](#)
- [NVIDIA G-SYNC Card](#)
 - [To Configure G-SYNC on one Viz Engine](#)
 - [To Configure the G-SYNC Card on Viz Engine Slaves](#)
 - [To Check the G-SYNC Status](#)
 - [Genlock \(House Sync\)](#)

To Configure NVIDIA Driver Settings for Viz Engine, Video mode

! **IMPORTANT!** For maximum performance when running the Viz Engine in VGA mode, please refer to the procedure [To Configure NVIDIA Driver Settings for Viz Engine, VGA mode](#) below.

1. Right-click the desktop and select the **NVIDIA Control Panel**.

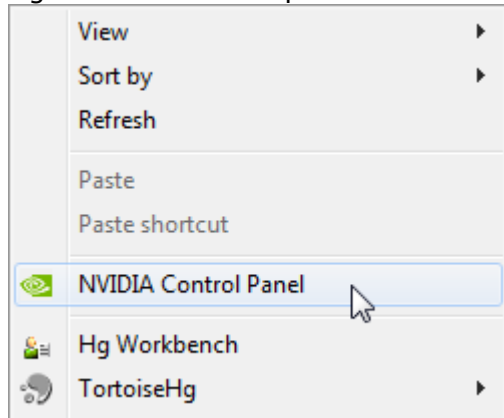

2. Click **Manage 3D settings**.

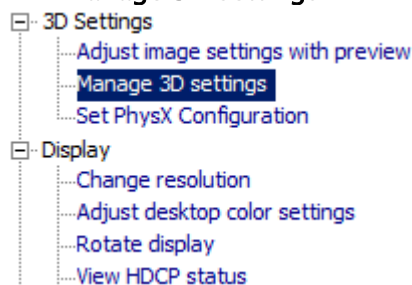

3. In **Global Settings** select the Global presets option **Base Profile**.

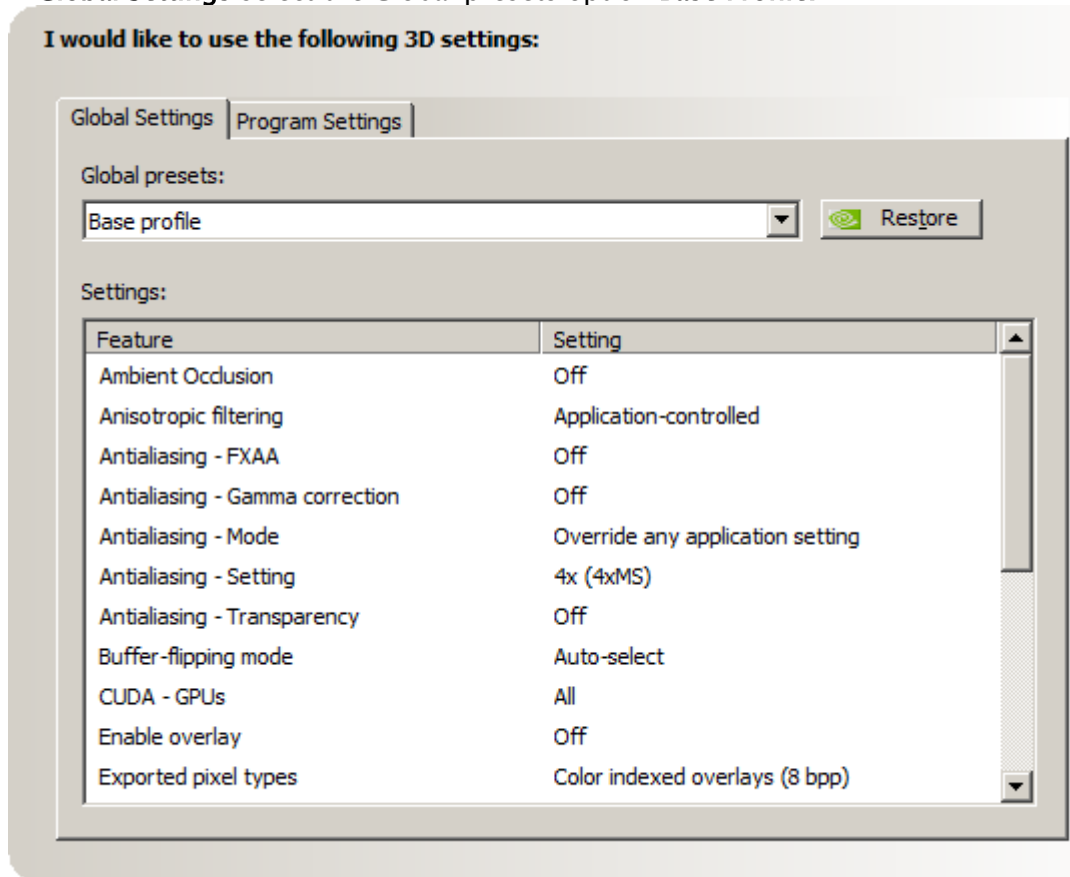

4. Set the following parameters:
 - **Ambient Occlusion:** Off.
 - **Anisotropic filtering:** Application controlled.
 - **Antialiasing-Gamma correction:** Off.
 - **Antialiasing-FXAA:** Off.
 - **Antialiasing-Mode:** Override any application settings.
 - **Antialiasing-Setting:** 4x (4xMS).
 - **Antialiasing-Transparency:** Off.
 - **Power management mode:** Prefer maximum performance.
 - **Vertical Sync:** Off (see **Vertical Sync** below).
5. In the **Global presets** drop down box select **Workstation App - Dynamic Streaming**.
6. Click on **Apply**.

To Configure NVIDIA Driver Settings for Viz Engine, VGA mode

For maximum performance when running the Viz Engine in VGA mode, follow the procedure [To Configure NVIDIA Driver Settings for Viz Engine, Video mode](#) outlined above, and observe the following changes:

1. In **Global Settings**, change the Global presets option to **3D App - Video Editing**.
2. The parameter for **Vertical Sync** must be set to On.

Vertical Sync

Notes for Vertical Sync:

- **Use the 3D application setting:** Use for Viz installations (running in Standard PC (VGA) mode) and for Video Wall setups where video is in use.
- **Off:** Use for Viz installations where video is in use (unless used for video walls).

Info Videowall: For Videowall installations, Vertical Sync must always be on.

To Configure Mosaic

If setting up a Video Wall, please refer to the [Video Wall Configuration](#) chapter.

1. Right-click the desktop and select the **NVIDIA Control Panel**.
2. Click **Set up Mosaic**.
3. Tick the **Enable Mosaic** box.
4. Tick all required displays.
5. Set the **Refresh rate**.
6. Set the **Resolution (per display)**.

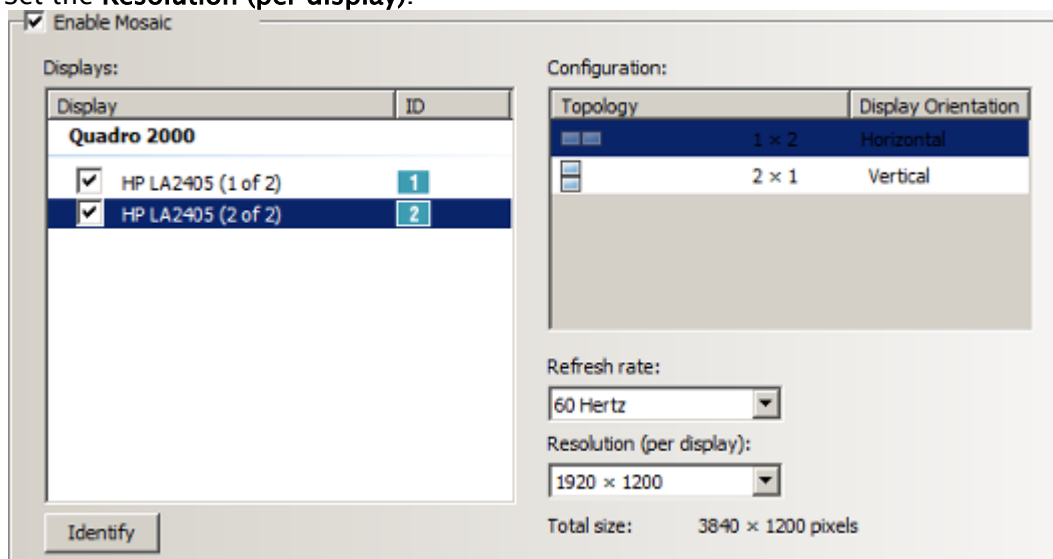

7. Click **Apply**.
8. Open Viz Config.
9. Click on **User Interface**.
10. Set **Screen Layout Mode** to **Mosaic Horizontal** or **Mosaic Vertical**.

NVIDIA G-SYNC Card

The G-SYNC card makes sure that all screens, which make up a Video Wall, are synchronized. When there are several Viz Engines in use, one is defined as the master and all the others as slaves. Pascal GPUs and higher require a gSync Gen2 version.

Make sure your gSync is running on the latest firmware:

Generation	Version
Quadro Sync 2	2.02
Quadro Sync	7.01

To Configure G-SYNC on one Viz Engine

1. On Viz Engine, go to the NVIDIA control panel.

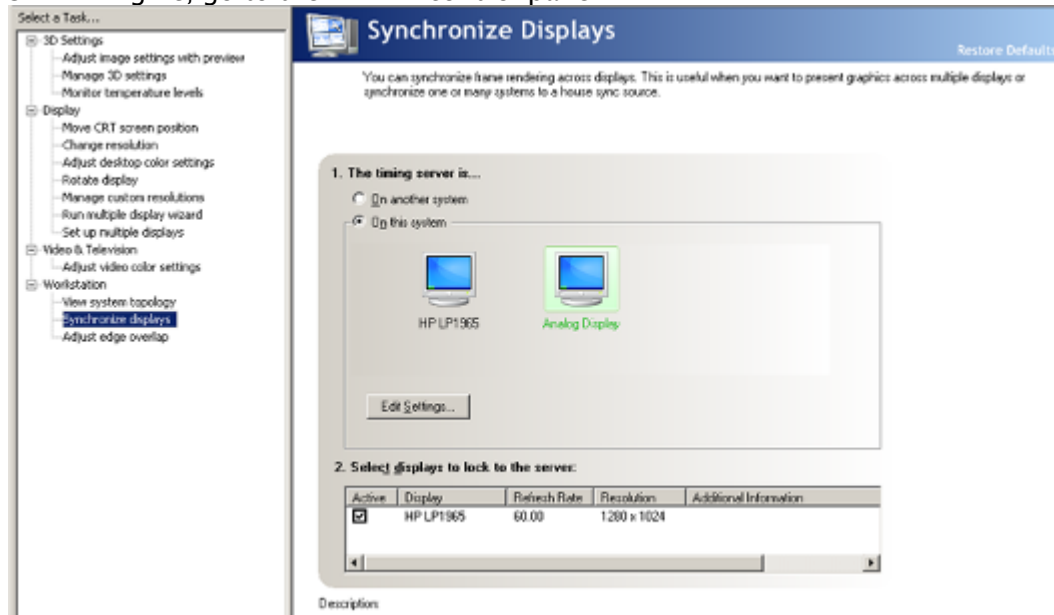

2. In **Workstation**, click **Synchronize displays**.
3. In **The timing server is...**, click **On this system**.
4. In **Select displays to lock to the server**, click each available display, in the field below, to make them active.

To Configure the G-SYNC Card on Viz Engine Slaves

Do this procedure on each Viz Engine slave.

1. On the Viz Engine slave, open the NVIDIA control panel.

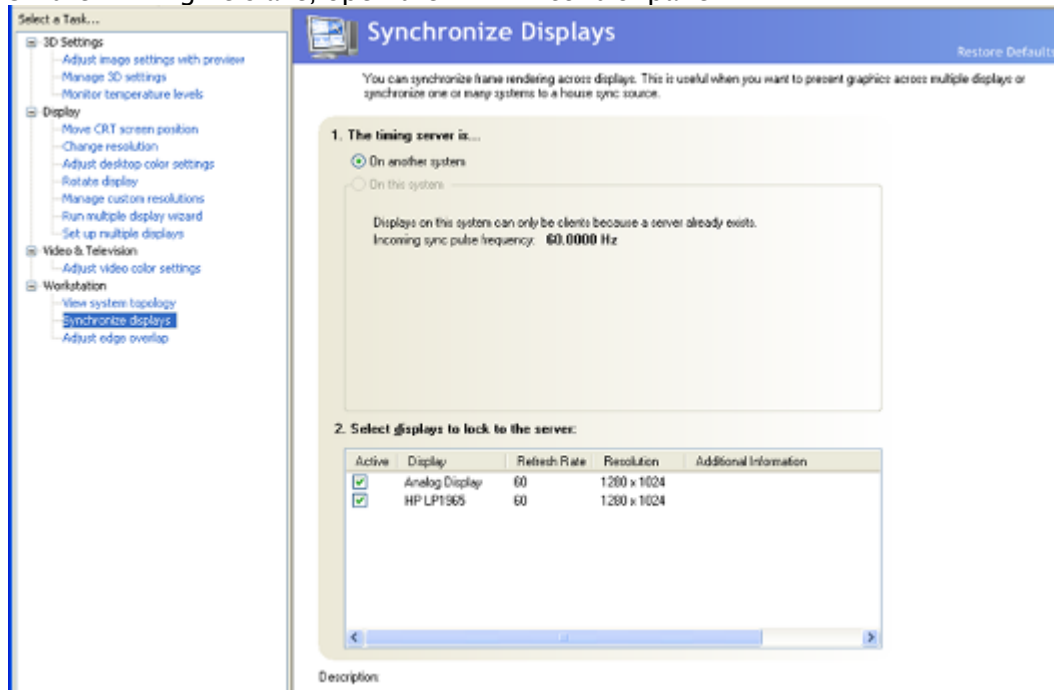

2. In **Workstation**, click **Synchronize displays**.
3. In **The timing server is...**, click **On another system**.
4. In **Select displays to lock to the server**, click each available display, in the field below, to make them active.

To Check the G-SYNC Status

1. On each machine, in turn, open the NVIDIA control panel.
2. In **Workstation**, click **View system topology**.
3. On the slave system, make sure that **Frame lock sync pulse is present** shows in the G-SYNC status portion on the lower part of the screen.

Genlock (House Sync)

There also the option to use a genlock (house sync) signal from the studio as an input to the G-SYNC card. In this case, once connected, check the signal in the **View system topology** screen, in **Workstation**. **House sync signal is not present** (1) means that no external genlock is connected and that the pulse is generated internally. If the external genlock is not used, this message can be ignored.

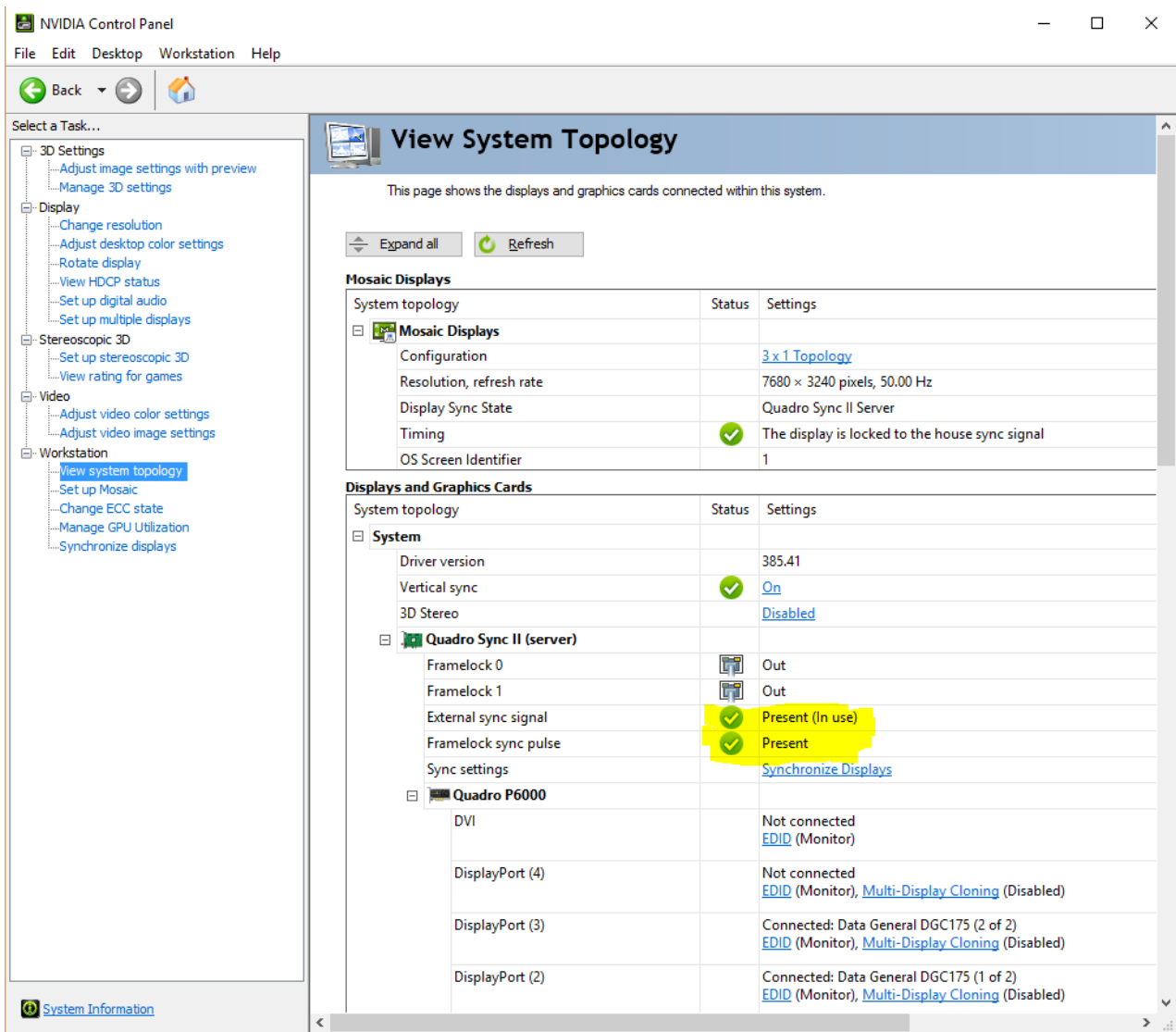

5.2.2 Supported GPUs and Driver History

- Supported nVidia GPUs
- Virtualized GPUs
- Driver History

Supported nVidia GPUs

The following graphic boards are officially supported by Viz Engine:

nVidia Volta Technology	nVidia Pascal Technology	nVidia Maxwell Technology	nVidia Kepler Technology
Quadro GV100	Quadro P1000	Quadro M2000	Quadro K600

nVidia Volta Technology	nVidia Pascal Technology	nVidia Maxwell Technology	nVidia Kepler Technology
	Quadro P2000	Quadro M4000	Quadro K2000/K2200
	Quadro P3200	Quadro M6000/ M6000 24GB	Quadro K4000/K4200
	Quadro P4000/P4200		Quadro K5000/K5200
	Quadro P5000/P5200		Quadro K6000
	Quadro P6000		

Virtualized GPUs

The following GPUs are supported in virtualized environments:

nVidia Grid Technology	
Grid M40	Grid K280Q
Grid M60	Grid K260Q
	Grid K2
	Grid K520

Driver History

Viz Artist/Engine Version	Driver
3.13.x	419.17
3.12.x	385.41
3.11.x	385.41
3.10.0	385.41
3.9.x	385.41
3.8.3	368.86
3.8.2	361.91
3.8.1	353.82
3.8.0	347.25

Viz Artist/Engine Version	Driver
3.6.4	341.21

i **Info:** There is no driver recommendation for virtual environments as they rely on the host operating system being used.

See Also

- [Video Wall Configuration](#)
- [Legacy Graphic Boards](#)

5.2.3 Working with Two or More GPUs

Multiple instances of Viz Engine can be spawned along multiple graphic cards. The assignment of the GPU to be used is done automatically, only the number of the instance needs to be set by the startup parameter `-u1, -u2` etc..

Some example use cases:

- **Two Program Outputs:** Using two instances that can run two program channels (for example, one for SD and one for HD output).
- **One Program Output and One Preview Output:** Running a control application with one instance for preview and one instance for program output with video. Ideal for outside broadcast environments.
- **One Program Output for Stereoscopy:** Producing graphics composited for stereoscopic use. In addition, this also saves rack unit space as all hardware is installed into one machine.
- Multiple frame servers on one machine.

⚠ Note: The limitations to such systems (in general and not limited to Vizrt systems alone) are memory usage, access and a lack of power redundancy. Also keep in mind that the memory usage of each machine needs to be covered by the system (for example, two P6000 with 24GB of texture memory require a machine with at least 48GB).

See Also

- [Working with Synchronous Output](#)

5.2.4 Working with Synchronous Output

With a dual channel setup it is easy to create two fill/key pairs for the left and right eye/camera during a stereo production. A special version of the Video Wall Distributor synchronously distributes one command to the two instances of the Viz Engine. For Viz Engine version 3.3 and later, it includes a built-in locking mechanism that makes sure both Viz Engines stay in sync, even if one of them drops a frame. This feature can be set On or Off by a simple command sent through the distributor.

This section contains information on the following topics:

- [Hardware Requirements](#)
- [Software Requirements](#)
- [Synchronous Output Configuration](#)
- [To Configure a Machine with Two Graphics Cards](#)

Hardware Requirements

- HP Z800 machine or better.
- Two NVIDIA Quadro (GPUs must be identical).
- Matrox X.mio2 (or newer) video in- and output card.

Software Requirements

- Viz Artist/Engine version 3.3 or later

Synchronous Output Configuration

The Viz Engine installer includes an option for dual channel support. Choosing this option generates desktop icons to start the configuration and the Viz Engine for channel 1 as well as for channel 2.

Note: Viz Artist is only available for channel 1 as it always runs on the first GPU.

The configurations use one video input per channel and embedded audio on the channel. The table below shows the main differences in the configurations:

	Viz Engine 1	Viz Engine 2
Stereo Mode	LEFT_EYE	RIGHT_EYE
Video In A	Video1	Unused
Video In B	Unused	Video 1
Video In C+D	Unused	Unused
Clip A	Clip 1	Clip 1
Clip B	Clip 2	Clip 2
Video Out A	Fill	Unused
Video Out B	Unused	Fill

	Viz Engine 1	Viz Engine 2
Video Out C	Key	Unused
Video Out D	Unused	Key
Communication Port	6700	6800

Since this configuration puts an extra load on the Matrox card, it is important to use the available resources with care:

- In the video section of the scene, switch off all unused layers.
- Let the GPU do the color conversion.
The Matrox card itself is synced through the first instance of Viz Engine.

It is important that only **one** display is active in the NVIDIA control panel. If you span the desktop across multiple GPUs, the affinity mask has no effect and both engines render on GPU.

To Configure a Machine with Two Graphics Cards

1. Install Viz Engine 3.3 or later and choose **Dual Channel** or **Viz Trio Box CG** setup.
2. From the Viz3 sub folder `ConfigExample/TrioOneBox` or `ConfigExample/DualChannel`, select the example Viz Config file that suits your desired video output format.
3. Create two copies of the selected Viz Config file and place them in your Viz3 directory and rename one to `VIZ-YOURHOSTNAME-0-0.cfg` and the other `VIZ-YOURHOSTNAME-1-0.cfg`.
4. Start Viz Config for both instances (channel 1 and channel 2) and enter settings for the Viz Graphics Hub (see [Database](#)) and enable Auto Log-in.
 - Auto log-in is needed as dual channel engines start without a UI.
 - For Viz Trio it is more a convenience factor, and not needed as such.
5. Start Viz Engine for channel 1 and then Viz Engine for channel 2.
 - Channel 1 signals are available on Matrox OutA (fill) and OutC (key).
 - Channel 2 signals are available on Matrox OutB (fill) and Out D (key).

 **Note: Viz Trio Box CG** requires Viz Trio 2.9 or later and Media Sequencer 1.19 or later. Viz Trio Box CG is a single channel setup where you have a program channel on the client machine in addition to your regular local Viz Engine preview.

See Also

- [Viz Command Line Options](#)
- The Camera section of the [Viz Artist User Guide](#)
- The Configuration Interface section of the [Viz Trio User Guide](#)

5.3 Supported Systems

- Note:** As a general recommendation for all hardware types:
- Disable all power saving options in Windows or in the BIOS Settings.
 - Disable Hibernate mode.
 - Disable Secure boot for driver installations (optional).

The installation of video, audio or graphics cards, is not required on a new system. However, for maintenance or upgrades, it is important to know how to install the different models.

All machines ordered from Vizrt are pre-installed and do not require any changes.

This section describes the all supported systems and their configuration supported by Viz Engine.

- IMPORTANT!** Any other setup than those described is not guaranteed to be supported by Vizrt and may cause problems during operation.

- Note:** Vizrt may make changes to specifications and product descriptions at any time, without notice.

This section contains information on the following topics:

- [HP Z8 G4](#)
- [HP Z4 G4](#)
- [HP Z840](#)
- [HP Z820](#)
- [HP Z800](#)
- [HP Z440](#)
- [HP Z400/Z420](#)
- [HP ZBook 17 G5](#)
- [Dell Precision R3930](#)
- [HP DL380 Gen9](#)
- [HP DL360 Gen9](#)
- [HP ZBook G3 Mobile Workstation](#)
- [Dell R7920](#)
- [Dell R7910 2U Rack Server](#)

5.3.1 HP Z8 G4

This section describes how to setup a HP Z8 G4 machine with the different cards provided by Vizrt. The HP Z8 G4 is a high performance workstation that can be configured with two CPUs, has 24 memory slots, multiple storage and PCIe configuration options.

More details about the HP Z8 can be found on HP's website: [HP Z8](#).

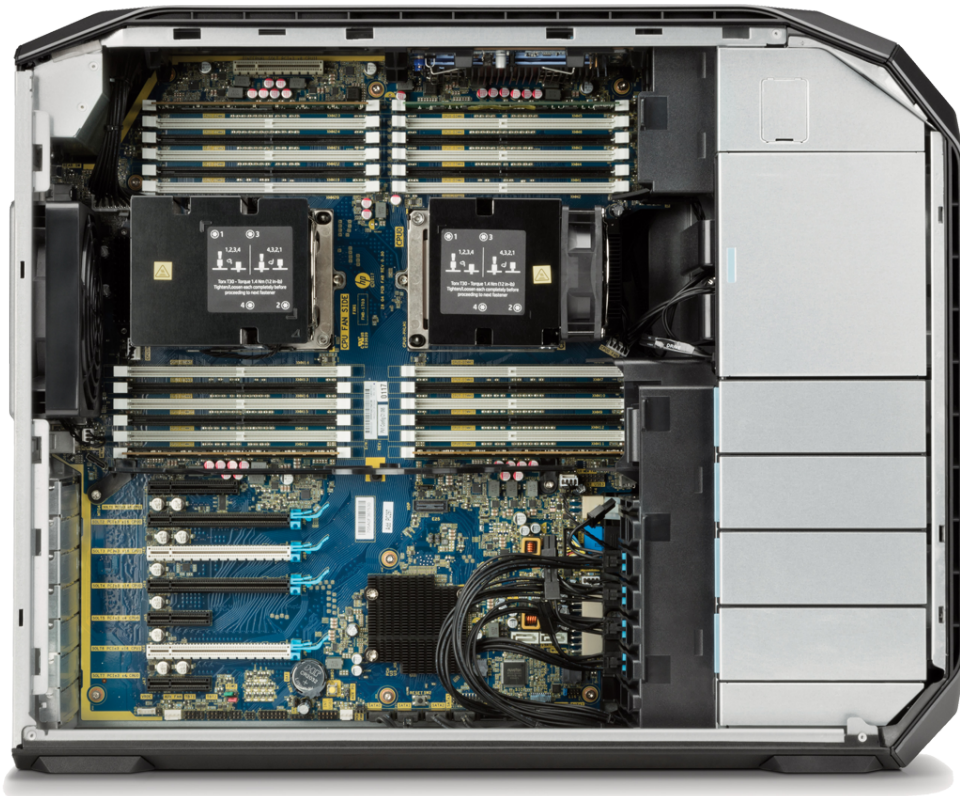

Info: Only newer Matrox Boards like xMio3 and DSX.LE4 are shipped with Z8 workstations. Older videoboard are not tested by Vizrt.

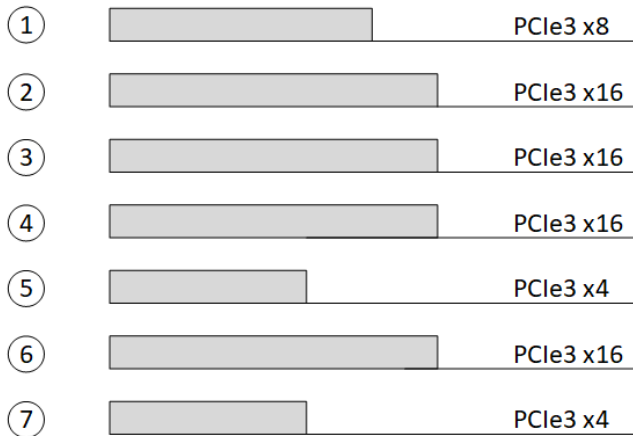

PCI Configuration for Single GPU

Slot	Usage
Slot 1 - PCIe3 x8	Matrox AES Audio G-Sync III Blue Storm Sea Level Single Port Network Card
Slot 2 - PCIe3 x16	Graphics Card (Single / Dual Slot)
Slot 3 - PCIe3 x16	Used if Dual Slot GPU is installed
Slot 4 - PCIe3 x16	If one Graphic Card is installed, this slot is used for Video Cards (i.e. Matrox Video Boards)
Slot 5 - PCIe3 x4	Empty or can be used by Matrox AES Audio if Slot 1 is used
Slot 6 - PCIe3 x16	Empty
Slot 7 - PCIe3 x4	Empty

PCI Configuration for dual GPU

Slot	Usage
Slot 1 – PCIe3 x8	Video Cards (i.e. Matrox Video Boards)
Slot 2 – PCIe3 x16	Matrox AES Audio G-Sync III Blue Storm Sea Level Single Port Network Card
Slot 3 – PCIe3 x16	Primary Graphics Card (Single / Dual Slot)
Slot 4 – PCIe3 x16	Primary Graphics Card (Dual Slot)
Slot 5 – PCIe3 x4	Empty or used by Matrox AES Audio if Slot 2 is used by extension card (G-Sync, Blue Storm, etc.)
Slot 6 – PCIe3 x16	Secondary Graphics Card (Single / Dual Slot)
Slot 7 – PCIe3 x4	Secondary Graphics Card (Dual Slot)

Default Hardware

- Tower 5RU
- CPU: 2x Intel Xeon Silver 4114 (2.2GHz 10-Core)
- RAM: 48 GB DDR 4 (6x 8GB)
- SSD1: 256 GB S-ATA (Operating System)
- SSD2: 512 GB M.2 NVMe (Data and Clips)
- RAID Controller: Intel SATA/NVMe M.2
- Power Supply: 1x 1125 W 90% Efficient

BIOS – Configuration

- During Post, press **F10** to access BIOS Setup.
- Click **Advanced Tab > Boot**.
 - Enable **Fast Boot**.
- Go back to **Advanced Tab > Secure Boot Configuration**.
 - Select: **Legacy Support Disable and Secure Boot Enable**.
- Go back to **Advanced Tab Overview**.
 - Click on **Build in Device**.
- Increase **PCIe Idle Fan Speed** to: 0050.
- Go back to **Advanced Tab Overview**.

- Click on **Performance Options**.
- Set **Intel Hyper Threading Technology** to DISABLED.
- Press **ESC** and save Configuration.

 **Info:** Certain third party vendor drivers require secure boot to be disabled to install properly.

5.3.2 HP Z4 G4

This section describes how to setup a HP Z4 G machine with the different cards provided by Vizrt. More details about the HP Z4 G4 can be found on HP's website: [HP Z4](#).

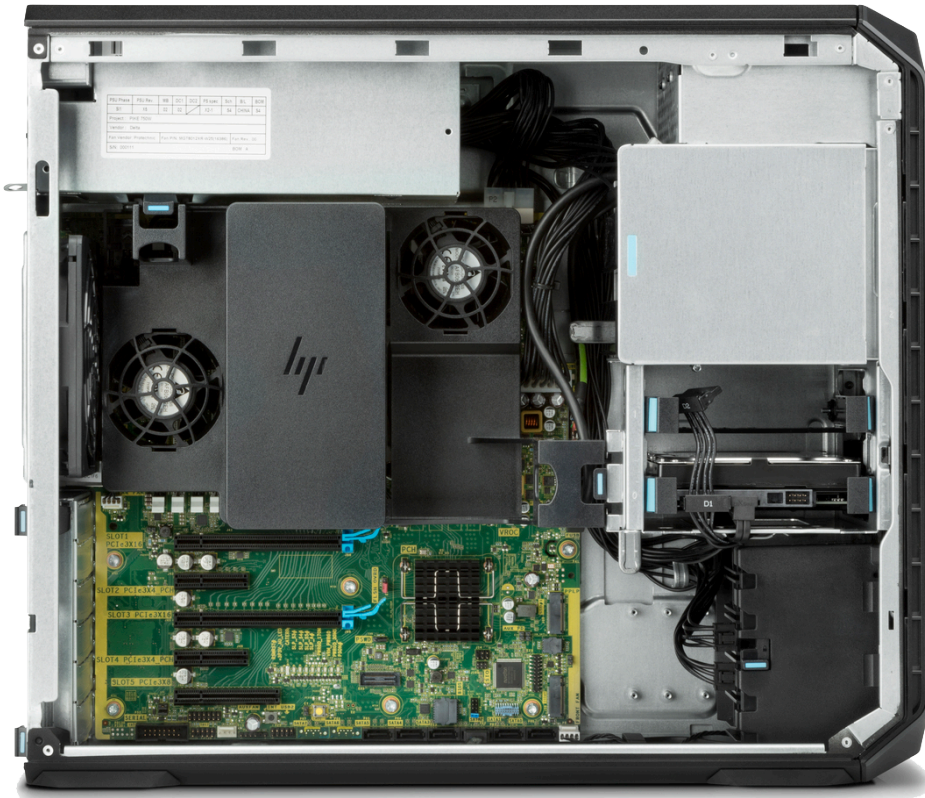

i Info: Only newer Matrox Boards like xMio3 and DSX.LE4 are shipped with Z4 G4 workstations. Older videobards are not tested by Vizrt.

PCI Configuration

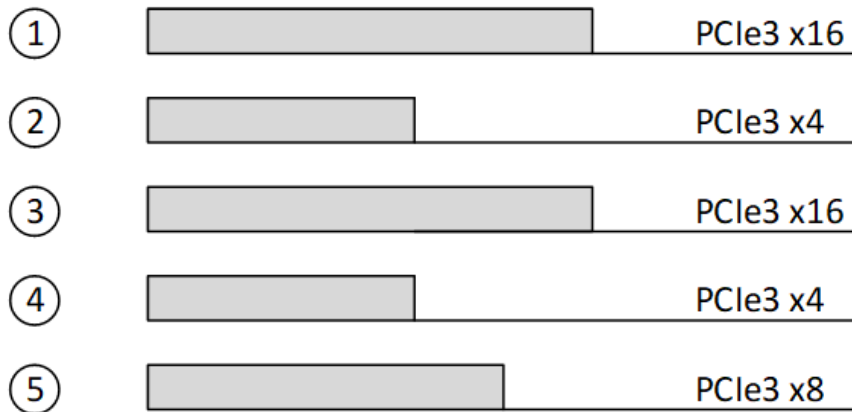

Slot	Configuration
Slot 1	Graphics Card only! (Single / Dual Slot)
Slot 2	Used if Dual Slot GPU is installed
Slot 3	Possible Expansion Card Installation: G-Sync Blue Storm Sea Level Single Port Network Card Video Cards (i.e. Matrox Video Boards)
Slot 4	Expansion Cards (see Slot 3, except Matrox Video Board)
Slot 5	Matrox AES Audio

Default Hardware

- Tower 4RU
- CPU Render: 1x Intel Xeon W-2102 (2.9GHz 4-Core)
- CPU Control: 1x Intel Xeon W-2133 (3.6GHz 6-Core)
- RAM Render: 32 GB DDR 4 (4x 8GB)
- RAM Control: 16 GB DDR 4 (2x 8GB)
- SSD1: 256 GB S-ATA (Operating System)
- SSD2: 512 GB M.2 NVMe (Data and Clips, only in Render PC)

- RAID Controller: Intel SATA/NVMe M.2
- Power Supply: 1x 750W 90% Efficient

BIOS Configuration

- During Post, press **F10** to access BIOS Setup.
- Click **Advanced Tab > Boot.**
 - Enable **Fast Boot.**
- Go back to **Advanced Tab > Secure Boot Configuration.**
 - Select: **Legacy Support Disable and Secure Boot Enable.**
- Go back to **Advanced Tab Overview.**
 - Click on **Build in Device.**
- Increase **PCIe Idle Fan Speed** to: 0050.
- Press **ESC** and save Configuration.

Info: Certain third party vendor drivers require secure boot to be disabled to install properly.

5.3.3 HP Z840

This section describes how to setup a HP Z840 machine with the different cards provided by Vizrt. The HP Z840 (5U rack units) is a high performance workstation that can be configured with two CPUs, has 16 memory slots, multiple storage and PCIe configuration options. More details about the HP Z840 can be found on HP's website: [HP Z840 Info](#) and [HP Z840 Support](#).



IMPORTANT! Before touching any components make sure you use an anti-static wrist strap to prevent electrostatic discharge.

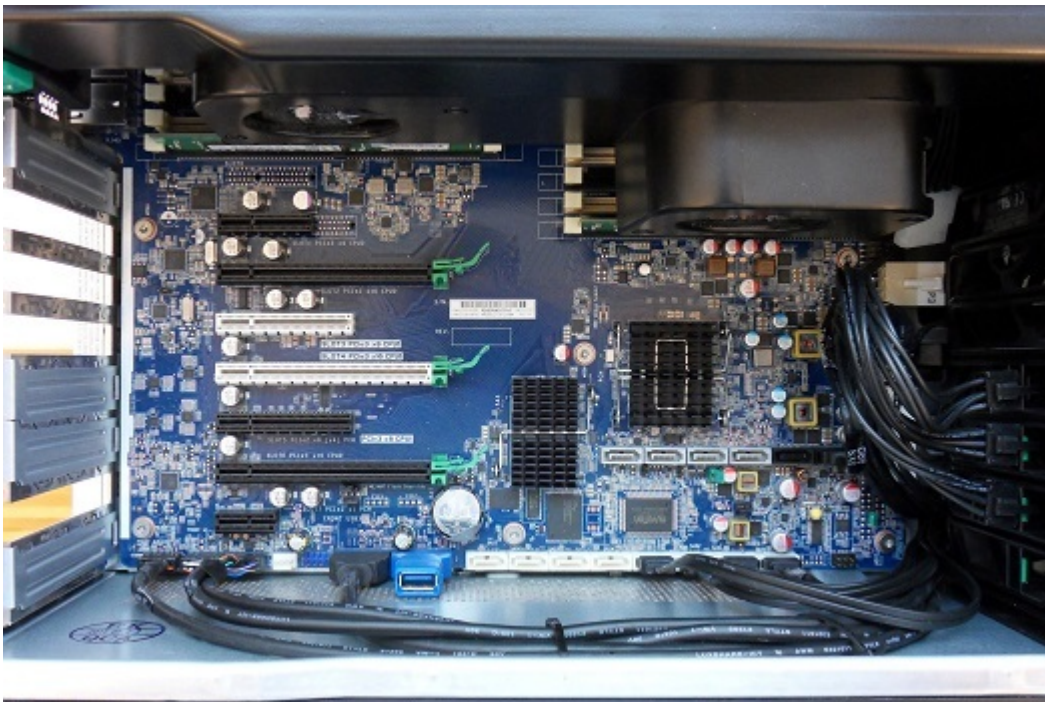

HP Z840 PCI/PCIe Slot Layout and Usage

Single GPU setups (one graphics device):

Slot #	Type	Used for
16	PCIe3 x4 - CPU0	AES Audio card (if required/used)
17	PCIe3 x16 - CPU0	Graphics card 1
18	PCIe3 x8 - CPU1	free
19	PCIe3 x16 - CPU1	free
20	PCIe3 x8 CPU1	free
21	PCIe3 x16 - CPU0	Video card (Matrox, DVS or Bluefish)
22	PCIe2 x1 - PCH	Radial Aerator (if needed, see note below)

Dual GPU setups (two graphics devices):

Slot #	Type	Used for
16	PCIe3 x4 - CPU0	AES Audio card (if required/used)

Slot #	Type	Used for
17	PCIe3 x16 - CPU0	Graphics card 1
18	PCIe3 x8 - CPU1	free
19	PCIe3 x16 - CPU1	Video card (Matrox, DVS or Bluefish)
20	PCIe3 x8 CPU1	free
21	PCIe3 x16 - CPU0	Graphics card 2
22	PCIe2 x1 - PCH	free

IMPORTANT! A Radial Aerator is recommended for the Matrox X.mio2 video boards. However, the Radial Aerator is not needed for video cards with an onboard fan, such as the Matrox X.mio3, DVS Atomix or Bluefish Epoch 4K Supernova. The Radial Aerator cannot physically be installed with the Xmio.2 Plus board, in which case the BIOS chassis fan speed setting must be set to maximum to achieve sufficient cooling.

Z840 BIOS Settings

- Advanced – Power Options – Fan Idle Mode
 - With one Graphic card: two steps below maximum: **
 - With two Graphic cards: maximum ****
- Advanced – Performance Options:
 - Intel Hyper Threading Technology: Disabled
 - QPI mode: Home Snoop

Memory expansion

Memory expansions must follow the predefined fill-order and memory-type requirements. There is a table documenting the memory fill order inside the server cabinet. Use this table as a reference when adding memory modules.

5.3.4 HP Z820

This section describes how to setup a HP Z820 machine with the different cards provided by Vizrt.

To Setup an HP Z820 with a Matrox board

PCI and PCIe slots, HP Z820

Audio card	16		PCIe3 x8(4)
Graphics card	17		PCIe3 x16
	18		PCIe3 x16(8)
	19		PCIe3 x16
	20		PCIe2 x8(4)
Video card	21		PCIe3 x16
Radial aerator	22		PCI 32bit/33MHz

IMPORTANT! Before touching any components make sure you use an anti-static wrist strap to prevent electrostatic discharge.

1. Disconnect the power and all other peripherals.
2. Insert the graphics card in slot 17.
3. Insert the Matrox video board in slot 21.
4. Insert the radial-aerator in slot 22.

IMPORTANT! The Matrox video boards can reach very high temperatures when in operation. If a X.mio.2 board is used, a radial-aerator must be installed. If a X.mio.2 Plus board is used a radial-aerator can not, physically, be installed. In this case the chassis fan speed (in BIOS) must be set to maximum to achieve sufficient cooling.

5. *Optional:* Insert the in slot 16.
6. *Optional:* Insert the extra slot panel for the X.mio2/44 board in any of the vacant slots, and connect it to the X.mio2 board.
7. Tidy up all cables and close the computer's casing. Once the machine is powered up, check that the Matrox X.mio board has been correctly installed. Check that the blue OB-light on the (top) backside of the slot panel is set to ON. If the LED is ON the board is correctly supplied with power.

To Setup an HP Z820 with two graphics cards

PCI and PCIe slots, HP Z820

Audio card	16		PCIe3 x8(4)
Graphics card	17		PCIe3 x16
	18		PCIe3 x16(8)
	19		PCIe3 x16
	20		PCIe2 x8(4)
Video card	21		PCIe3 x16
Radial aerator	22		PCI 32bit/33MHz

IMPORTANT! Before touching any components make sure you use an anti-static wrist strap to prevent electrostatic discharge.

1. Disconnect the power and all other peripherals.
2. Insert the weaker graphics card in slot 17.
3. Insert the stronger graphics card in slot 19.
4. Insert the Matrox video board in slot 21.
5. Insert the radial-aerator in slot 22.

IMPORTANT! A radial-aerator is mandatory as the video board reaches high temperatures during operation.

6. *Optional:* Insert the [Matrox](#) video board in slot 16.
7. Tidy up all cables and close the computer's casing.
8. Connect the computer's monitor to the graphics card in slot 17.
9. Start the machine.
10. In the BIOS (Advanced: Thermal – Full Fan speed) set all fans to run at full speed.
11. Boot and log on to the machine.
12. Install the NVIDIA and Matrox drivers.
13. Open the NVIDIA Control Panel, and click on System Information in the bottom left corner and check that both graphics cards are installed and run at PCIe x16 speed.
14. Open Matrox [X.info](#) from the system tray and check that the video board runs at PCIe x8 speed.

Once the machine is powered up, check that the Matrox X.mio board has been correctly installed. Check that the blue OB-light on the (top) backside of the slot panel is set to ON. If the LED is ON the board is correctly supplied with power.

5.3.5 HP Z800

HP Z800 PCI/PCIe Slot Layout and Usage

Single GPU setups (one graphics device):

Slot #	Type	Used for
16	PCIe2 x8	AES Audio card (if required/used)
17	PCIe2 x16	Graphics card 1
18	PCIe x8	free
19	PCIe2 x16	Video card (Matrox, DVS or Bluefish)
20	PCIe2 x16	Radial Aerator (if needed, see note below)
21	PCI 32/33	free
22	PCIe x16	free

Dual GPU setups (two graphics devices):

Slot #	Type	Used for
16	PCIe2 x8	AES Audio card (if required/used)
17	PCIe2 x16	Graphics card 1
18	PCIe x8	free
19	PCIe2 x16	Video card (Matrox, Bluefish)
20	PCIe2 x16	Graphics card 2
21	PCI 32/33	free
22	PCIe x16	free

⚠ IMPORTANT! A Radial Aerator is recommended for the Matrox X.mio2 video boards. However, the Radial Aerator is not needed for video cards with an onboard fan, such as the Matrox X.mio3, DVS Atomix or Bluefish Epoch 4K Supernova. The Radial Aerator cannot physically be installed with the Xmio.2 Plus board, in which case the BIOS chassis fan speed setting must be set to maximum to achieve sufficient cooling.

HP Z800

This section describes how to setup a HP Z800 machine with the different cards provided by Vizrt.

To Setup an HP Z800 with a BlueFish444 Epoch Board

PCI-X, PCI And AGP Slots, HP Z800

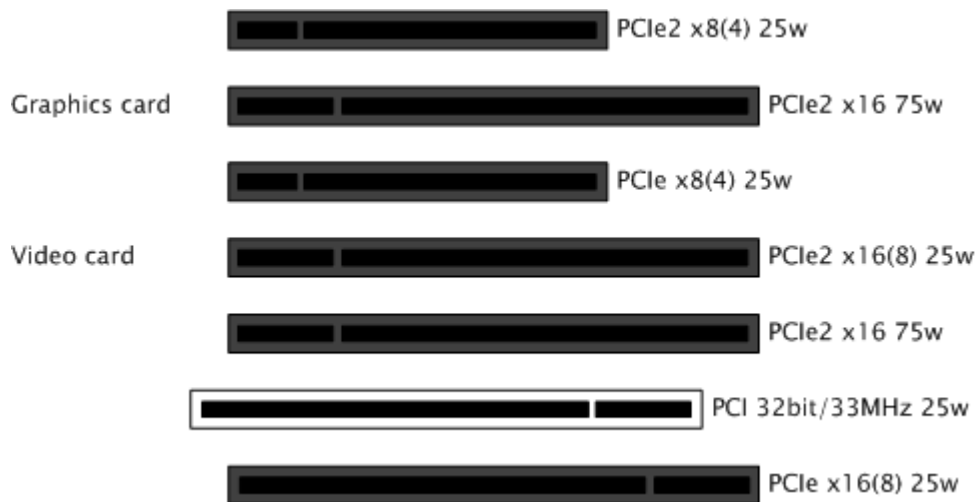

1. Disconnect the power and all other peripherals.
2. Insert the graphics card in the PCIe slot number 2 from the top.
3. Insert the BlueFish444 video board in the PCIe slot number 4 from the top.

To Setup an HP Z800 with a Matrox Board

PCI And PCIe Slots, HP Z800

Audio card		PCIe2 x8(4) 25w
Graphics card		PCIe2 x16 75w
		PCIe x8(4) 25w
		PCIe2 x16(8) 25w
Video card		PCIe2 x16 75w
		PCI 32bit/33MHz 25w
Radial aerator		PCIe x16(8) 25w

1. Disconnect the power and all other peripherals.
2. Insert the graphics card in PCIe2 slot number 2 from the top.
3. Insert the Matrox video board into the PCIe2 slot number 5 from the top.
4. Insert the radial-aerator into the PCIe slot number 7 from the top.

⚠ IMPORTANT! The Matrox video boards can reach very high temperatures when in operation. If a Xmio.2 board is used, a radial-aerator must be installed. If a Xmio.2 Plus board is used a radial-aerator can not, physically, be installed. In this case the chassis fan speed (in BIOS) must be set to maximum to achieve sufficient cooling.

5. *Optional:* Insert the [Matrox](#) video board into the PCIe2 slot number 1 from the top.
6. *Optional:* Insert the extra slot panel for the X.mio2/44 board in any of the vacant slots, and connect it to the X.mio2 board.
7. Tidy up all cables and close the computer's casing. Once the machine is powered up you may verify that the Matrox X.mio board has been correctly installed by looking for the blue OB-light on the (top) backside of the slot panel. A lit light indicates that the board is correctly supplied with power.

To Setup an HP Z800 with Two Graphics Cards

PCI And PCIe Slots, HP Z800



⚠ IMPORTANT! Before touching any components make sure you use an anti-static wrist strap to prevent electrostatic discharge.

1. Disconnect the power and all other peripherals.
2. Insert the weaker graphics card in PCIe2 slot number 2 from the top.
3. Insert the stronger graphics card in PCIe2 slot number 5 from the top.
4. Insert the Matrox video board in the PCIe2 slot number 4 from the top.
5. Insert the radial-aerator into the PCIe slot number 3 from the top. A radial-aerator is mandatory as the video board reaches high temperatures during operation.
6. *Optional:* Insert the [Matrox](#) video board into the PCIe2 slot number 1 from the top.
7. Tidy up all cables and close the computer's casing.
8. Connect the computer's monitor to the graphics card in slot 2 from the top.
9. Start the machine and in the BIOS (Advanced: Thermal - Full Fan speed) set all fans to run at full speed.
10. Boot and log on to the machine.
11. Install NVIDIA and Matrox drivers.
12. Open the NVIDIA Control Panel, and click on System Information in the bottom left corner and check that both graphics cards are installed and run at PCIe x16 speed.
13. Open Matrox [X.info](#) from the system tray and check that the video board runs at PCIe x8 speed.
Once the machine is powered up you may verify that the Matrox X.mio board has been correctly installed by looking for the blue OB-light on the (top) backside of the slot panel. A lit light indicates that the board is correctly supplied with power.

5.3.6 HP Z440

This section describes how to setup a HP Z440 machine with the different cards provided by Vizrt. The HP Z440 (4U rack units) is a high performance single-CPU workstation with 8 memory slots,

multiple storage and PCIe configuration options. More details about the HP Z440 can be found on HP's website: [HP Z440 Info](#).



HP Z440 with NVIDIA K6000 card, Matrox X.mio2:



HP Z440 PCI/PCIe Slot Layout and Usage

Slot #	Type	Used for
13	PCIe2 x1	AES Audio card (if the video card has it)
14	PCIe3 x16	Graphic card
15	PCIe2 x4	Unused/Free

Slot #	Type	Used for
16	PCIe3 x8	Video Card (Matrox, DVS or Bluefish)
17	PCIe3 x16	Radial Aerator, if needed, see note below
18	PCI 32/33	Unused/Free

Note: Radial Aerato is recommended for the X.mio2 and X.mio2 Plus boards. However, for video cards that have an onboard fan, such as the X.mio3, DSX LE 4, DVS Atomix or Bluefish Epoch 4K Supernova cards, this is not needed.

Z440 BIOS Settings

- Advanced – Power Options – Fan Idle Mode
 - Default is two steps below maximum: **
 - Fan can be set to maximum, if temperatures are high.

Memory expansion

Memory expansions must follow the predefined fill-order and memory-type requirements. There is a table documenting the memory fill order inside the server cabinet. Refer to that table when adding memory modules. Memory configurations with more than four memory DIMMs installed, require the [HP Z440 Memory Cooling Solution](#) (AMO kit P/N J2R52AA). This fan can be obtained from Vizrt, or directly from HP.







5.3.7 HP Z400/Z420

This section describes how to setup a HP Z420 machine with the different cards provided by Vizrt:

- [To Setup an HP Z420 with a BlueFish444 Epoch Board](#)
 - PCI-X, PCI and AGP slots, HP Z420
- [To Setup an HP Z420 with a Matrox Board](#)
 - PCI and PCIe slots, HP Z420

To Setup an HP Z420 with a BlueFish444 Epoch Board

PCI-X, PCI and AGP slots, HP Z420

Audio card	19		PCIe2 x4(1)
Graphics card	20		PCIe3 x16
	21		PCIe2 x8(4)
Video card	22		PCIe3 x8
Radial aerator	23		PCIe3 x16
	24		PCI 32bit/33MHz

IMPORTANT! Before touching any components make sure you use an anti-static wrist strap to prevent electrostatic discharge.







1. Disconnect the power and all other peripherals.
2. Insert the graphics card in slot 20.
3. Insert the BlueFish444 video board in slot 22.

Note: If you are using the BNC adapter with the Epoch|2K Horizon board it can be placed directly adjacent the video board on either side.

4. Tidy up all cables and close the computer's casing.

To Setup an HP Z420 with a Matrox Board

PCI and PCIe slots, HP Z420

Audio card	19		PCIe2 x4(1)
Graphics card	20		PCIe3 x16
	21		PCIe2 x8(4)
Video card	22		PCIe3 x8
Radial aerator	23		PCIe3 x16
	24		PCI 32bit/33MHz

1. Disconnect the power and all other peripherals.
2. Insert the graphics card in slot 20.
3. Insert the Matrox video board in slot 22.

4. Insert the radial-aerator in slot 23.

IMPORTANT! A radial-aerator is mandatory as the video board reaches high temperatures during operation.

5. *Optional:* Insert the **Matrox** video board in slot 19.
6. *Optional:* Insert the extra slot panel for the X.mio2/44 board in any of the vacant slots, and connect it to the X.mio2 board.
7. Tidy up all cables and close the computer’s casing.
8. Start the machine. The Matrox X.mio2+ gets very hot in the HP Z420. Make sure that the HP Z420 Fan and Front Card Guide Kit is installed, and set the fan speed to the highest value in BIOS (**Power > Thermal**).

Once the machine is powered up, check that the Matrox X.mio board has been correctly installed. Check that the blue OB-light on the (top) backside of the slot panel is set to ON. If the LED is ON the board is correctly supplied with power.

5.3.8 HP ZBook 17 G5

	<p>Default Hardware:</p> <ul style="list-style-type: none"> • Display: 17.3 inch Ultra HD • CPU: Intel Core i7-8850H 6-Core • RAM: 32 GB DDR 4 • SSD M.2: 1TB <p>Graphics Card: NVidia Quadro P5200 16GB</p>
--	--

The HP ZBook 17 G5 can be used in combination with a Sonnet Echo Express SE1 Thunderbolt 3 Box and Matrox DSXLE4 or XMio3. This allows for the following maximum number of inputs:

	1080i50	1080p50	720p50	1080p60M	1080i60M	720p60M
Inputs	8	7	8	6	8	8

5.3.9 Dell Precision R3930

This section describes the specification and PCI board layout of a Dell R3930 machine with the different cards provided by Vizrt.



Default Hardware

- Server 1RU
- OS: Windows 10 IoT Enterprise LTSC 2019
- CPU: 1x Intel Xeon E-2186G 6-Core
- RAM: 32 GB DDR 4 (4x 8GB)
- 1st SSD: 256 GB S-ATA SSD
- 2nd SSD: 512 GB M.2 on Mainboard
- RAID Controller: Intel Onboard
- Hot Plug Power Supply: 2x 550W

Connectors

	Front connectors	Back connectors
	<ol style="list-style-type: none"> 1. HDD activity light 2. Hard drive (4x2.5") 3. Audio jack 4+5. USB 3.1 (Type C) 6. SD card reader 7. Power button/ power light 8. Information tag 	<ol style="list-style-type: none"> 9. PCIe x8 or unused if 10. is PCIe x16 10. PCIe x16 or PCIe x8 if 9. is used 11. PCIe x4 slot 12. USB 3.1 (Type C)/iGFX DisplayPort (2x) 13. Remote power switch connector 14. Serial port 15. 10G RJ-45 Ethernet 16. 1G RJ-45 Ethernet 17. Redundant dual 550W power supplies

PCI Configuration with P4000 or P6000

Slot	Usage
Slot 1	GPU
Slot 2	unused, otherwise GPU would not run PCIe x16
Slot 3	Matrox DSXLE4 or other PCIe card

PCI Configuration with P2000

Slot	Usage
Slot 1	GPU (Runs at PCIe x8 Speed if Slot 2 is used)
Slot 2	Sealevel GPI, Plura Timecode, Bluestorm RS422
Slot 3	Sealevel GPI, Plura Timecode, Bluestorm RS422

PCI Configuration with Onboard GPU (Intel HD620)

Slot	Usage
Slot 1	Sealevel GPI, Plura Timecode, Bluestorm RS422
Slot 2	Sealevel GPI, Plura Timecode, Bluestorm RS422
Slot 3	Sealevel GPI, Plura Timecode, Bluestorm RS422

⚠ Note: Intel HD620 onboard GPU uses USB-C type connector. In most cases an Adapter is required to connect a Monitor.

BIOS Settings

- During Post, press **F2** to get access to the BIOS Setup.
- General - Advanced Boot Options - **uncheck** Legacy Option ROMs
- Performance - Intel Speed Step - **uncheck** "Enable Intel Speed Step"
- Performance - C-States Control - **uncheck** "C States"
- Thermal Configuration - CPU Zone: set speed to **20%**
- Thermal Configuration - PSU and PCIe Zone: set speed to **20%** If working under high ambient temperatures, fan speed may be set to a higher value.

Note: Certain third party vendor drivers require secure boot to be disabled to install properly.

5.3.10 HP DL380 Gen9

The HP DL380 Gen9 is a 2U rack mountable server. This is a dual-CPU server with 24 DIMM slots, which comes configured with Windows Server 2008 R2 or Windows Server 2012 R2. This server can be configured with up to two dual slot [Graphics Boards](#). Dual GPU configurations require the system to be configured with Windows Server 2012 R2.

HP DL380 Gen9 PCI/PCIe Slot Layout and Usage

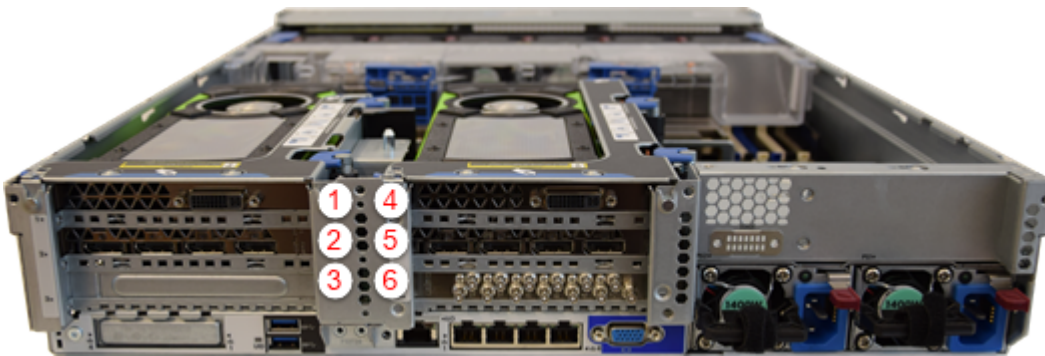

Slot #	Used for
1	Empty
2	Graphics card 1
3	Optional AES Audio for Matrox X.mio3
4	Empty
5	Graphics card 2
6	Matrox X.mio3 IP / DSX LE 4 IP , Matrox X.mio 3 / DSX LE 4 , or Matrox DSX LE4 video card

Note: Other video boards are not tested with this server.

HP DL380 Gen 9 BIOS Settings

Setting	Value
System Options > Processor Options > Hyperthreading	Disabled
Performance Options > Node Interleaving	Enabled
Performance Options > QPI Snoop Configuration	Home Snoop
Advanced Options > Video Options > Add-in Video	Enabled
Advanced Options > Video Options > Embedded Video	Disabled
Power Management > Power Profile	Maximum Performance
Boot Options > UEFI Optimized Boot:	
For systems running Windows Server 2008R2	Disabled
For systems running Windows Server 2012R2	Enabled

5.3.11 HP DL360 Gen9

The HP DL360 Gen9 is a space-saving **1U** server. This is a dual-CPU server with 24 DIMM slots, which is configured with Windows Server 2008 R2. Only single slot [Graphics Boards](#) can be used, either **M2000** or **M4000**.

There are two expansion slots:

- One for the Graphic Card.
- One for a [Matrox X.mio3](#) or [DSX LE 4](#) video card.

The HP DL360 Gen9 with Quadro K4200 and DSXLE3 video I/O:

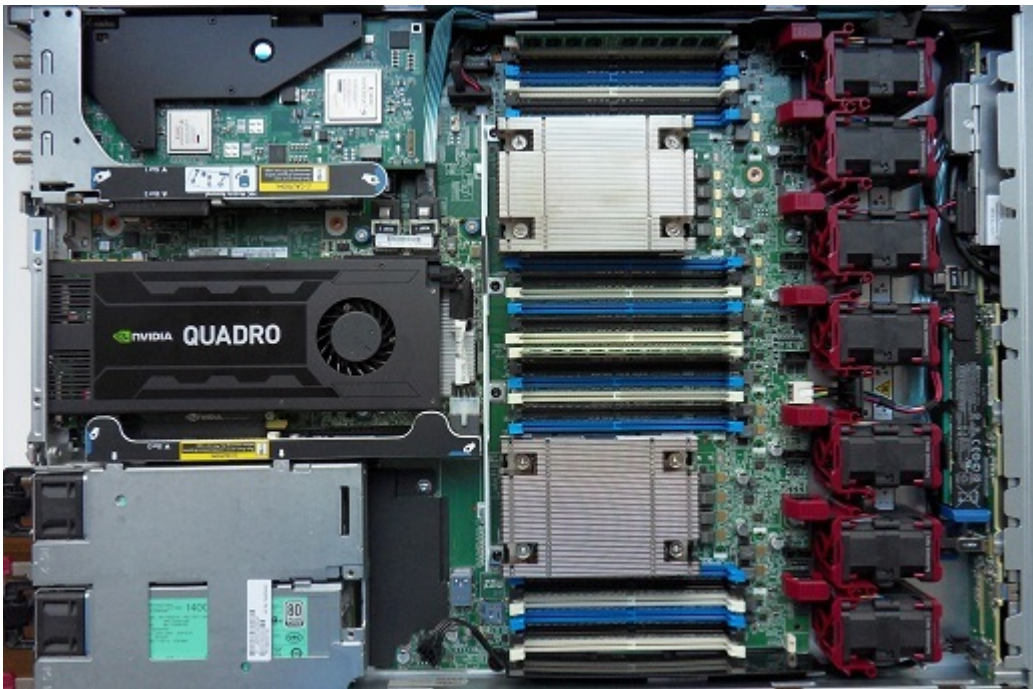

HP DL360 Gen9 BIOS Settings

Setting	Value
System Options > Processor Options > Hyperthreading	Disabled
Performance Options > Node Interleaving	Enabled
Performance Options > QPI Snoop Configuration	Home Snoop
Advanced Options > Video Options > Add-in Video	Enabled
Advanced Options > Video Options > Embedded Video	Disabled
Power Management > Power Profile	Maximum Performance
Boot Options > UEFI Optimized Boot:	
For systems running Windows Server 2008 R2	Disabled
For systems running Windows Server 2012 R2	Enabled

5.3.12 HP ZBook G3 Mobile Workstation

The HP ZBook is a mobile workstation available as 15 and 17 inch models with the powerful Intel Core i7 CPU, from 16 to 64 gigabytes of RAM, and a full HD resolution display.



The 15-inch model can be used for design and control applications, as it features a full HD display and an NVIDIA Quadro M1000M or NVIDIA M2000M graphics card, depending on the configuration.

The 17-inch model can, in addition to design and control applications, also be used for SDI productions. It is available with either an NVIDIA Quadro M4000M or NVIDIA Quadro M5000M video card. For SDI productions, the HP ZBook must be extended with an [AJA Io 4K](#) external video board and require a Thunderbolt 3 to Thunderbolt 2 adapter.

Both models come with the Microsoft Windows 7 Professional 64 bit operating system.

HP ZBook BIOS settings

Setting	Value
Advanced > Built-In Device Options > Graphics	Discrete Graphics

This BIOS setting is required to make sure Viz Engine runs only on the NVIDIA graphic card, and not on the built-in Intel HD graphic card.

See Also

- [AJA Io 4K](#)

5.3.13 Dell R7920



Dell R7920 Rack Workstation Slots



Slot	Usage
Slot 1 - PCIe3 x8	Graphics Card only! (Single / Dual Slot)
Slot 2 - PCIe3 x8	Used if a Dual-Slot Graphics Card is installed Matrox AES Audio
Slot 3 - PCIe3 x8	Video Card (i.e. Matrox Video Board)
Slot 4 - PCIe3 x16	Expansion Cards: Matrox AES Audio Blue Storm SeaLevel
Slot 5 - PCIe3 x8	Video Card (i.e. Matrox Video Board) (if two Graphics Cards are installed)
Slot 6 - PCIe3 M2 SSD	PCIe M.2 SSD
Slot 7 - PCIe3 x8	Used if a Dual-Slot Graphics Card is installed

Slot	Usage
Slot 7 – PCIe3 x8	Second Graphics Card

 **Note:** Only Matrox boards have been tested.

BIOS Settings

- During Post, press **F2** to get access to the BIOS Setup.
 - Click on **System BIOS**.
 - Click on **Processor Settings**.
 - Set **Logical Processor** to **DISABLED**.
 - Press **ESC** to Exit Menu.
- Click on **SATA Settings**.
 - Set **Embedded SATA** to **RAID MODE**.
 - Press **ESC** to Exit Menu.
- Click on **NVMe Settings**.
 - Set **NVMe Mode** to **NonRAID**.
 - Press **ESC** to Exit Menu.
- Click on **Boot Settings**.
 - Check if **Boot Mode** set to **UEFI**.
 - Press **ESC** to Exit Menu.
- Click on **Integrated Devices**.
 - Set **Embedded Video Controller** to **DISABLED**.
 - Press **ESC** to Exit Menu.
- Click on **System Profile Settings**.
 - Set **System Profile** to **Performance**.
 - Press **ESC** twice, Settings are saved.
- Exit Bios.
- Press **F2** to access BIOS.
- Click on **Boot Settings**.
- Change **Boot Order** (C should be at top).
- **Save Changes and Exit**.

 **Note:** Only newer Matrox Boards like xMio3 and DSX.LE4 are supported with Dell R7920 workstations. Older videobards are not tested by Vizrt.

 **Note:** Certain third party vendor drivers require secure boot to be disabled to install properly.

5.3.14 Dell R7910 2U Rack Server

The Dell R7910 Rack Workstation is a high-performance 2U Rack server. It is a dual-CPU server with 24 DIMMS memory slots, and can be configured with high-end Quadro graphics, Matrox Video I/O, and AES Audio.



Dell R7910 Rack Workstation Slots

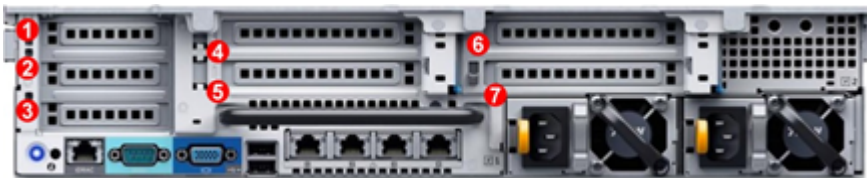

Slot	Usage
Slot 1 - PCIe3 x8	Empty
Slot 2 - PCIe3 x8	AES Audio if needed in an Opus Setup If 2x 2 Slot Graphics Cards are installed, this slot is used for Low Profile Video Cards like DSXLE4 Series.
Slot 3 - PCIe3 x8	Empty
Slot 4 - PCIe3 x16	Matrox AES Audio G-Sync III Blue Storm Sea Level Single Port Network Card 2nd Graphics Card

Slot	Usage
Slot 5 - PCIe3 x8	Video Cards (i.e. Matrox Video Boards) Used if a 2nd Dual-Slot Graphics Card is installed
Slot 6 - PCIe3 x16	First Graphics Card
Slot 7 - no Slot	If 2x Single Slot Graphics Cards and a Video Card is installed, this slot is used for AES Audio Used if a Dual-Slot Graphics Card is installed

⚠ Note: Only Matrox boards have been tested.

BIOS settings

BIOS Setting	Value
Memory settings	Snoop Mode - Home Snoop
Processor settings	Logical Processor - disabled
SATA Settings	Embedded SATA - Raid Mode
Boot Settings	Boot Mode: BIOS
Integrated Devices	Embedded Video Controller - disabled

5.4 Video Boards

This section describes the all supported Video IO boards, their configuration and drivers supported by Viz Engine.

⚠ IMPORTANT! Any other setup than those described is not guaranteed to be supported by Vizrt and may cause problems during operation.

⚠ Note: Vizrt may make changes to specifications and product descriptions at any time, without notice.

This section contains information on the following topics:

- [Matrox Hardware](#)
- [BlueFish444](#)
- [AJA Hardware](#)

5.4.1 Matrox Hardware

Viz Engine supports a wide range of Matrox products. This chapter provides an overview of the different Matrox video cards and dongles supported by Viz Engine, as well as providing their common installation procedures.

The Matrox X.mio series boards are used as Vizrt's HD, SD and 4K multi-channel video- and audio I/O solution. The original Matrox X.mio is considered legacy. There are currently three generations of the Matrox X.mio boards: The Matrox X.mio2 and X.mio2 plus, and Matrox X.mio3.

- **X.mio3** was introduced in 2015 and is supported by Viz Engine 3.8 and higher.
- **X.mio2 Plus** brought new features such as Matrox Control Engine (MCE) and advanced failsafe capabilities, compared to the X.mio2.
- **X.mio2** is mainly used for Virtual Studio due to low latency requirements. Since Viz Engine 3.8.2, the preferred video card for Virtual Studio solutions is the Matrox X.mio3 card.

This section contains information on the following topics:

- [Matrox X.mio3 12G](#)
- [Matrox X.mio3 IP / DSX LE 4 IP](#)
- [Matrox X.mio 3 / DSX LE 4](#)
- [Matrox X.mio2 and X.mio2 Plus](#)
- [Matrox M264 S1/S2/S3](#)
- [Matrox DSX LE3 Series](#)
- [Matrox X.RIO](#)
- [Matrox X.Open](#)
- [Audio Cable Assignment](#)
- [Matrox Driver Installation](#)
- [Troubleshooting Matrox Video Hardware](#)

Matrox X.mio3 12G

The Matrox X.mio3 12G video board is targeted for the growing UHD market. It is a half-length, full height PCI Express card that offers two 12G SDI inputs and two 12G SDI outputs, using one input and one output module manufactured by Embrionix. The card is based on the original Matrox X.mio3 design and is capable of handling one input and fill/key output, or two inputs and one fill output.

 **Important:** Due to the increased bandwidth of the signal, it is important to use high quality cables and as few connection points as possible. It is not recommended to use converter cables from Mini-BNC to standard BNC.

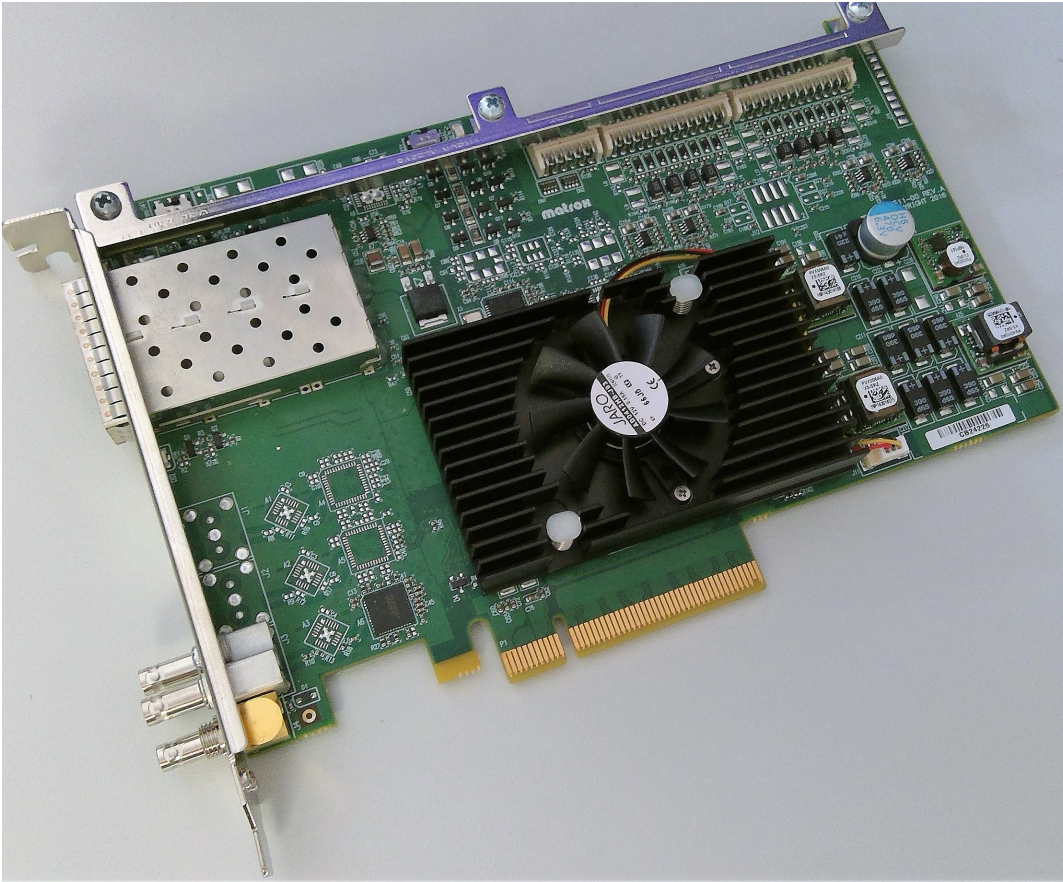

There is one Mini-BNC connector used to connect the card to the house genlock signal. The other two connectors are not implemented.

Key Features

- Half-length PCI Express card.
- Up to two 12G SDI inputs.
- Up to two 12G SDI outputs.
- Frame synchronizers on each input.
- VANC and HANC support for each input and output.
- Analog blackburst reference input (tri-level or bi-level).
- Onboard 4K scaler.
- Onboard 4K compositor.
- Up to 16 channels of AES/EBU inputs and outputs.

Matrox X.mio3 12G Configuration

The main video properties match those of a Matrox X.mio3, meaning you can have either one UHD input and one Fill/Key UHD output, or two UHD inputs and one Fill UHD output. Please see [Matrox Configuration Section](#) for further details.

Embrionix SFP I/O Modules

The needed 12G SFPs are available in two flavors, one for input and one for output. To connect to the SFPs standard Mini-BNC cables can be used.



Matrox X.mio3 12G SFP Configuration

It is important that the seating of SFPs is correct, otherwise inputs and outputs are not available. The output SFP goes into the lower bay and the input SFP into the upper one. See pictures for reference.

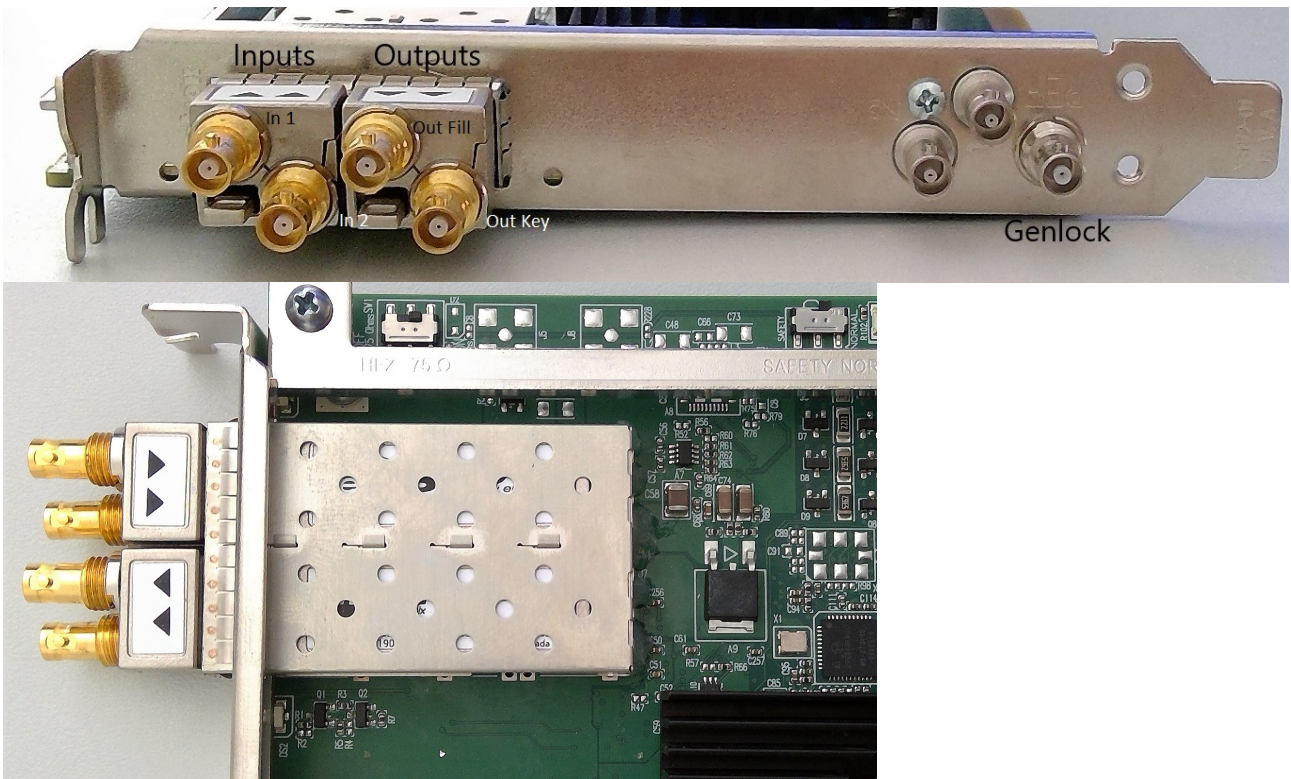

Matrox X.mio3 IP / DSX LE 4 IP

The Matrox X.mio3 IP video board was designed to help broadcast equipment manufacturers meet the challenges of the SDI to IP transition. It is a half-height, half-length PCIe card that offers multi-channel video I/O over 10 GbE with IP encapsulation of HD and 3G video. The card offers a total of four IP inputs and four IP outputs. The stream content conforms either to the SMPTE 2022-6 or the SMPTE ST 2110 specification. SMPTE ST 2022-7 is supported in both modes.

DSX LE 4 IP cards have the same capabilities as their X.mio3 counterparts, but lack an onboard video mixer, so DVE is not usable on those boards. Whenever X.mio3 IP is mentioned in this document, the same is true for DSX LE 4 IP.

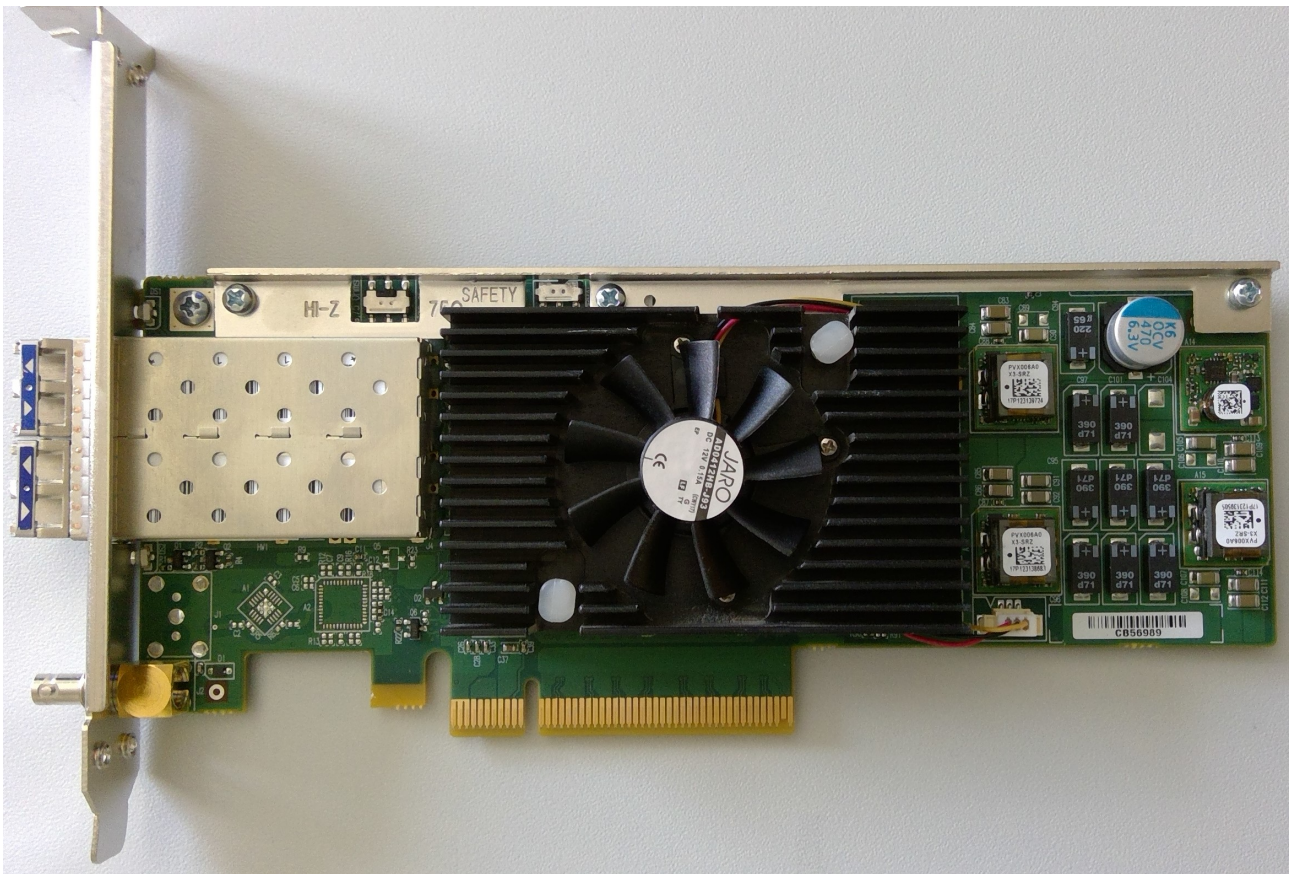

The card contains two enhanced small form-factor pluggable (SFP+) slots, or "bays". In the lower bay is **SFP A**, and hosts input and output channels 1 through 4. The upper bay houses **SFP B**, which hosts all of the redundant channels used with SMPTE ST 2022-7. The board does not have any SDI inputs or outputs. There is one Mini-BNC connector used to connect the card to the house genlock signal. However, the card can also be locked to a SMPTE ST 2059 conform time signal, sent via the SFPs.

Be aware that SFPs come in two flavors:

- Short range (SR, 850 nm), and
- Long range (LR, 1310 nm).

In general, a cable may only connect two SFPs of the same type. In addition, please be aware that the SFP should not be constantly switched in and out of the X.mio3 IP card, as the warranty on the card may be voided if this occurs more than 40 times.

Key Features

- Dual SFP+ cages for a total of four video inputs and four video outputs
- IP (SMPTE ST 2059 PTP) and analog blackburst timing reference
- Guaranteed non-bursty packet transmission
- Onboard multi-channel Up/Down/Cross scaler
- Onboard multi-layer compositor

Matrox X.mio3 IP Configuration And IP Properties

The main video properties of the IP input channels are very similar to live input channels on a Matrox card. These properties are accessible in the [Video Input: Stream Input](#) section of Viz Configuration.

Fill and Key Channel Mapping

When an output channel uses the alpha channel, a key channel is created. This is always the next numbered output channel:

- Fill is on output 1, and key is on output 2.
- Fill is on output 3, and key is on output 4.

⚠ Note: It is possible for a dual channel setup to use independent output channels on one SFP, for example 1 and 2. In this case, the **Use alpha** property must be disabled for both channels.

Default IP Properties

The default IP configuration is meant to serve as placeholder only. It is required to change those default values to match your internal IP landscape. All IP related settings were moved to a separate configuration file. To get the file, Viz Engine must be started at least once. After that, the configuration can be changed using the commands mentioned below, or by editing the file *ipconfig.xml*, located in the ProgramData directory of Viz Engine. The manual step is necessary for all settings not linked to a command. Please refer to the section below for further information.

Configuration Settings

The configuration of the IP settings was moved to an XML file containing IP relevant parameters only.

⚠ Note: When editing the XML file, do not delete any tags and only edit values between `<tag>` and `</tag>`.

SFP Settings

Setting	Description
IPv4Address	Indicates the static IPv4 address.

Setting	Description
IPV4Gateway	Indicates the IPv4 Gateway.
IPv4Netmask	Indicates the IPv4 Netmask.
Smpte2059SfpSettings::TypeOfServiceDSCP	Indicates that the Type of Service (ToS) is Differentiated Service Code Point (DSCP). Range is [0..63] (6 bits).
Smpte2059SfpSettings::DelayMechanism	Indicates the type of delay mechanism to use for the time server connection. 0 = Invalid 1 = EndToEnd 2 = PeerToPeer
Smpte2059SfpSettings::IpMode	Indicates the type of internet protocol mode to use for the time server connection. 0 = Invalid 1 = Multicast 2 = Unicast 3 = Hybrid
Smpte2059SfpSettings::MasterClockDomain Number	Indicates the time server clock domain number to use.
Smpte2059SfpSettings::JoinType	Indicates the type of membership request made. 0 = Invalid 1 = None 2 = IGMPv2 3 = IGMPv3
Smpte2059SfpSettings::IgmPV3Settings::FilterType	Only needed when the join type is set to 3 = IGMPv3. Indicates the filter type applied. 0 = Invalid 1 = Inclusion 2 = Exclusion
Smpte2059SfpSettings::IgmPV3Settings::FilterListCount	Indicates the number of IPv4 source addresses in the filter list. Maximum is four.
Smpte2059SfpSettings::IgmPV3Settings::FilterList	Indicates the list of IPv4 source addresses to filter separated by commas.

General Output Settings for SMPTE ST 2022-6 and SMPTE ST 2110

Setting	Description
Redundancy	If set to true, enables the redundant stream for seamless reconstruction conforming to SMPTE ST 2022-7.

Video Output Settings for SMPTE ST 2022-6 and SMPTE ST 2110

Setting	Description
RtpPayloadId	For SMPTE ST 2110 only: Indicates the RTP (Real-time Transfer Protocol) payload ID.
TimeToLive	Indicates the time in which packets can be used in seconds. That is, it indicates the packets' Time to live (TTL).
TypeOfServiceDSCP	Indicates that the Type of Service (ToS) is Differentiated Service Code Point (DSCP). Range is [0..63] (6 bits).
TypeOfServiceECN	Indicates that the Type of Service (ToS) is Explicit Congestion Notification (ECN). Range is [0..3] (2 bits).
Primary::SrcUdpPort	Indicates the User Datagram Protocol (UDP) port of the sender (that is, transmitter).
Primary::DstAddress	Indicates the IPv4 address of the destination (that is, receiver). Only used in multicast.
Primary::DstUdpPort	Indicates the UDP port of the destination (that is, receiver).
Secondary::SrcUdpPort	Indicates the redundant stream UDP port of the sender (that is, transmitter).
Secondary::DstAddress	Indicates the redundant stream IPv4 address of the destination (that is, receiver). Only used in multicast.
Secondary::DstUdpPort	Indicates the redundant stream UDP port of the destination (that is, receiver).

Audio Output Settings for SMPTE ST 2110 only

Setting	Description
RtpPayloadId	Indicates the RTP (Real-time Transfer Protocol) payload ID.
TimeToLive	Indicates the time in which packets can be used in seconds. That is, it indicates the packets' Time to live (TTL).
TypeOfServiceDSCP	Indicates that the Type of Service (ToS) is Differentiated Service Code Point (DSCP). Range is [0..63] (6 bits).
TypeOfServiceECN	Indicates that the Type of Service (ToS) is Explicit Congestion Notification (ECN). Range is [0..3] (2 bits).

Setting	Description
AudioPacketDuration	Indicates the outgoing audio packet duration. 1 = 125 µs 4 = 1 ms All other values are not supported.
Primary::SrcUdpPort	Indicates the User Datagram Protocol (UDP) port of the sender (that is, transmitter).
Primary::DstAddress	Indicates the IPv4 address of the destination (that is, receiver). Only used in multicast.
Primary::DstUdpPort	Indicates the UDP port of the destination (that is, receiver).
Secondary::SrcUdpPort	Indicates the redundant stream UDP port of the sender (that is, transmitter).
Secondary::DstAddress	Indicates the redundant stream IPv4 address of the destination (that is, receiver). Only used in multicast.
Secondary::DstUdpPort	Indicates the redundant stream UDP port of the destination (that is, receiver).

Ancillary Data Output Settings for SMPTE ST 2110 only

Setting	Description
RtpPayloadId	Indicates the RTP (Real-time Transfer Protocol) payload ID.
TimeToLive	Indicates the time in which packets can be used in seconds. That is, it indicates the packets' Time to live (TTL).
TypeOfServiceDSCP	Indicates that the Type of Service (ToS) is Differentiated Service Code Point (DSCP). Range is [0..63] (6 bits).
TypeOfServiceECN	Indicates that the Type of Service (ToS) is Explicit Congestion Notification (ECN). Range is [0..3] (2 bits).
SMPTE352Payload	If set to 1, enables SMPTE 352 packets.
Primary::SrcUdpPort	Indicates the User Datagram Protocol (UDP) port of the sender (that is, transmitter).
Primary::DstAddress	Indicates the IPv4 address of the destination (that is, receiver). Only used in multicast.
Primary::DstUdpPort	Indicates the UDP port of the destination (that is, receiver).

Setting	Description
Secondary::SrcUdpPort	Indicates the redundant stream UDP port of the sender (that is, transmitter).
Secondary::DstAddress	Indicates the redundant stream IPv4 address of the destination (that is, receiver). Only used in multicast.
Secondary::DstUdpPort	Indicates the redundant stream UDP port of the destination (that is, receiver).

General Input Settings for SMPTE ST 2022-6 and SMPTE ST 2110

Setting	Description
Redundancy	If set to true, enables the redundant stream for seamless reconstruction conforming to SMPTE ST 2022-7.
JoinType	Indicates the type of membership request made. 0 = Invalid 1 = None 2 = IGMPv2 3 = IGMPv3

Video Input Settings for SMPTE ST 2022-6 and SMPTE ST 2110

Setting	Description
RtpPayloadId	For SMPTE ST 2110 only: Indicates the RTP (Real-time Transfer Protocol) payload ID.
Primary::DstAddress	Indicates the reception multicast IPv4 address.
Primary::DstUdpPort	Indicates the reception User Datagram Protocol (UDP) port.
Primary::PacketIntervalThreshold	Indicates the threshold for generating the time interval between the IP packets alarm on the video flow. The range is from 6.4 ns to 419424.0 ns in intervals of 6.4 ns.
Primary::IgmPV3Settings::FilterType	Only needed when the join type is set to 3 = IGMPv3. Indicates the filter type applied. 0 = Invalid 1 = Inclusion 2 = Exclusion
Primary::IgmPV3Settings::FilterListCount	Indicates the number of IPv4 source addresses in the filter list. Maximum is four.
Primary::IgmPV3Settings::FilterList	Indicates the list of IPv4 source addresses to filter separated by commas.

Setting	Description
Secondary::DstAddress	Indicates the redundant stream reception multicast IPv4 address.
Secondary::DstUdpPort	Indicates the redundant stream reception UDP port.
Secondary::PacketIntervalThreshold	Indicates the threshold for generating the time interval between the IP packets alarm on the video flow. The range is from 6.4 ns to 419424.0 ns in intervals of 6.4 ns.
Secondary::IcmpV3Settings::FilterType	Only needed when the join type is set to 3 = IGMPv3. Indicates the filter type applied. 0 = Invalid 1 = Inclusion 2 = Exclusion
Secondary::IcmpV3Settings::FilterListCount	Indicates the number of IPv4 source addresses in the filter list. Maximum is four.
Secondary::IcmpV3Settings::FilterList	Indicates the list of IPv4 source addresses to filter separated by commas.

Audio Output Settings for SMPTE ST 2110 only

Setting	Description
RtpPayloadId	For SMPTE ST 2110 only: Indicates the RTP (Real-time Transfer Protocol) payload ID.
AudioPacketDuration	Indicates the outgoing audio packet duration. 1 = 125 μ s 4 = 1 ms All other values are not supported.
Primary::DstAddress	Indicates the reception multicast IPv4 address.
Primary::DstUdpPort	Indicates the reception User Datagram Protocol (UDP) port.
Primary::PacketIntervalThreshold	Indicates the threshold for generating the time interval between the IP packets alarm on the audio flow. The range is from 102.4 ns to 6710681.6 ns in intervals of 102.4 ns.

Setting	Description
Primary::IgmPV3Settings::FilterType	Only needed when the join type is set to 3 = IGMPv3. Indicates the filter type applied. 0 = Invalid 1 = Inclusion 2 = Exclusion
Primary::IgmPV3Settings::FilterListCount	Indicates the number of IPv4 source addresses in the filter list. Maximum is four.
Primary::IgmPV3Settings::FilterList	Indicates the list of IPv4 source addresses to filter separated by commas.
Secondary::DstAddress	Indicates the redundant stream reception multicast IPv4 address.
Secondary::DstUdpPort	Indicates the redundant stream reception UDP port.
Secondary::PacketIntervalThreshold	Indicates the threshold for generating the time interval between the IP packets alarm on the audio flow. The range is from 102.4 ns to 6710681.6 ns in intervals of 102.4 ns.
Secondary::IgmPV3Settings::FilterType	Only needed when the join type is set to 3 = IGMPv3. Indicates the filter type applied. 0 = Invalid 1 = Inclusion 2 = Exclusion

Ancillary Data Output Settings for SMPTE ST 2110 only

Setting	Description
RtpPayloadId	For SMPTE ST 2110 only: Indicates the RTP (Real-time Transfer Protocol) payload ID.
Primary::DstAddress	Indicates the reception multicast IPv4 address.
Primary::DstUdpPort	Indicates the reception User Datagram Protocol (UDP) port.
Primary::PacketIntervalThreshold	Indicates the threshold for generating the time interval between the IP packets alarm on the ancillary data flow. The range is from 819.2 ns to 53685452.8 ns in intervals of 819.2 ns.

Setting	Description
Primary::IgmPV3Settings::FilterType	Only needed when the join type is set to 3 = IGMPv3. Indicates the filter type applied. 0 = Invalid 1 = Inclusion 2 = Exclusion
Primary::IgmPV3Settings::FilterListCount	Indicates the number of IPv4 source addresses in the filter list. Maximum is four.
Primary::IgmPV3Settings::FilterList	Indicates the list of IPv4 source addresses to filter separated by commas.
Secondary::DstAddress	Indicates the redundant stream reception multicast IPv4 address.
Secondary::DstUdpPort	Indicates the redundant stream reception UDP port.
Secondary::PacketIntervalThreshold	Indicates the threshold for generating the time interval between the IP packets alarm on the ancillary data flow. The range is from 819.2 ns to 53685452.8 ns in intervals of 819.2 ns.
Secondary::IgmPV3Settings::FilterType	Only needed when the join type is set to 3 = IGMPv3. Indicates the filter type applied. 0 = Invalid 1 = Inclusion 2 = Exclusion

Change IP Properties

Although the IP properties may be changed by editing the configuration file directly, the IP address and port numbers can also be set via the command line interface. Because channel numbering is zero-based here, **Output Channel 1** is referred to as `VIDEOOUT_0`. To check the currently configured values call the command using GET (instead of SET) without parameters.

To Change/Check The Destination Address And Port Of The Output Channels:

For SMPTE ST 2022-6/-7 and SMPTE ST 2110:

```
MAIN*CONFIGURATION*MATROX*VIDEOOUT_x*DSTADDRESS SET xxx.xxx.xxx.xxx
MAIN*CONFIGURATION*MATROX*VIDEOOUT_x*DSTUDPPORT SET xxxxx
```

```
MAIN*CONFIGURATION*MATROX*VIDEOOUT_x*REDUNDANCYDSTADDRESS SET xxx.xxx.xxx.xxx
MAIN*CONFIGURATION*MATROX*VIDEOOUT_x*REDUNDANCYDSTUDPPORT SET xxxxx
```

For SMPTE ST 2110 only:

```
MAIN*CONFIGURATION*MATROX*VIDEOOUT_x*DSTADDRESSAUDIO SET xxx.xxx.xxx.xxx
MAIN*CONFIGURATION*MATROX*VIDEOOUT_x*DSTUDPPORTAUDIO SET xxxxx
```

```
MAIN*CONFIGURATION*MATROX*VIDEOOUT_x*REDUNDANCYDSTADDRESSAUDIO SET xxx.xxx.xxx.xxx
MAIN*CONFIGURATION*MATROX*VIDEOOUT_x*REDUNDANCYDSTUDPPORTAUDIO SET xxxxx
```

```
MAIN*CONFIGURATION*MATROX*VIDEOOUT_x*DSTADDRESSANC SET xxx.xxx.xxx.xxx
MAIN*CONFIGURATION*MATROX*VIDEOOUT_x*DSTUDPPORTANC SET xxxxx
```

```
MAIN*CONFIGURATION*MATROX*VIDEOOUT_x*REDUNDANCYDSTADDRESSANC SET xxx.xxx.xxx.xxx
MAIN*CONFIGURATION*MATROX*VIDEOOUT_x*REDUNDANCYDSTUDPPORTANC SET xxxxx
```

To Change The Source Address Of The Input Channels:

For SMPTE ST 2022-6/-7 and SMPTE ST 2110:

```
MAIN*CONFIGURATION*CHANNELS*STREAMIN_x*DSTADDRESS SET xxx.xxx.xxx.xxx
MAIN*CONFIGURATION*CHANNELS*STREAMIN_x*DSTUDPPORT SET xxxxx
```

```
MAIN*CONFIGURATION*CHANNELS*STREAMIN_x*REDUNDANCYDSTADDRESS SET xxx.xxx.xxx.xxx
MAIN*CONFIGURATION*CHANNELS*STREAMIN_x*REDUNDANCYDSTUDPPORT SET xxxxx
```

For SMPTE ST 2110 only:

```
MAIN*CONFIGURATION*CHANNELS*STREAMIN_x*DSTADDRESSAUDIO SET xxx.xxx.xxx.xxx
MAIN*CONFIGURATION*CHANNELS*STREAMIN_x*DSTUDPPORTAUDIO SET xxxxx
```

```
MAIN*CONFIGURATION*CHANNELS*STREAMIN_x*REDUNDANCYDSTADDRESSAUDIO SET xxx.xxx.xxx.xxx
MAIN*CONFIGURATION*CHANNELS*STREAMIN_x*REDUNDANCYDSTUDPPORTAUDIO SET xxxxx
```

```
MAIN*CONFIGURATION*CHANNELS*STREAMIN_x*DSTADDRESSANC SET xxx.xxx.xxx.xxx
MAIN*CONFIGURATION*CHANNELS*STREAMIN_x*DSTUDPPORTANC SET xxxxx
```

```
MAIN*CONFIGURATION*CHANNELS*STREAMIN_x*REDUNDANCYDSTADDRESSANC SET xxx.xxx.xxx.xxx
MAIN*CONFIGURATION*CHANNELS*STREAMIN_x*REDUNDANCYDSTUDPPORTANC SET xxxxx
```

X.mio3 IP Command Examples

Set the source address of input channel 4. Because channel numbering is zero-based here, **IP Input Channel 4** is referred to as STREAMIN_3.

```
MAIN*CONFIGURATION*CHANNELS*STREAMIN_3*DSTADDRESS SET 224.10.10.34
```

Set the source UPD port of input channel 4:

```
MAIN*CONFIGURATION*CHANNELS*STREAMIN_3*DSTUDPPORT SET 9004
```

Query the destination properties of output 1, fill

```
> MAIN*CONFIGURATION*MATROX*VIDEOOUT_0*DSTADDRESS GET
< 224.10.10.102
> MAIN*CONFIGURATION*MATROX*VIDEOOUT_0*DSTUDPPORT GET
< 20000
```

Query the destination properties of the key channel associated with output 1:

```
> MAIN*CONFIGURATION*MATROX*VIDEOOUT_1*DSTADDRESS GET
< 224.10.10.104
> MAIN*CONFIGURATION*MATROX*VIDEOOUT_1*DSTUDPPORT GET
< 20000
```

NMOS IS-04 Configuration

- Configure Viz Engine as usual
- Open `%ProgramFiles%\Matrox DSX.utils\System64\Axxxxxx.json` with any text editor, where `Axxxxxx` is the serial number of your installed Matrox IP card.
- Edit the mandatory entries: Registration Server IP and port must point to the RDS (Registration & Discovery Server).

It is recommended to set the Control IP and port to the values shown in the following example:

i Example

```
"enabled": true,
"registration server IP": "10.1.1.100",
"registration server port": 4210,
"control IP": "0.0.0.0",
"control port": 8080
```

- Optional: Edit all the labels, so that they can easily be identified in control applications or NMOS explorers.
- **Save** the file and restart either the machine or `mvNetworkService` from Windows services.

Matrox X.mio 3 / DSX LE 4

This section first gives an overview of the Matrox X.mio3 video cards, then describes the details specific to the full height [X.mio3 FH](#) and low profile [X.mio3 LP](#) versions of the card. The [Matrox X.mio3 IP / DSX LE 4 IP](#) board is discussed in a separate section.

DSX LE 4 cards have the same capabilities as their X.mio3 counterparts, but lack an onboard video mixer, so DVE is not usable on those boards. Whenever X.mio3 is mentioned in this document, the same is true for DSX LE 4.

In this section:

- [Matrox X.mio3 Overview](#)
- [X.mio3 FH](#)
- [X.mio3 LP](#)
 - [Key features](#)
 - [X.mio3 Connector Mapping Reference](#)
- [X.mio3 I/O Port Configuration](#)
- [Viz Engine Matrox Video Mapping Configuration](#)
- [To Upgrade X.mio3 Class and Firmware](#)
- [X.mio3 AES Audio Kit](#)

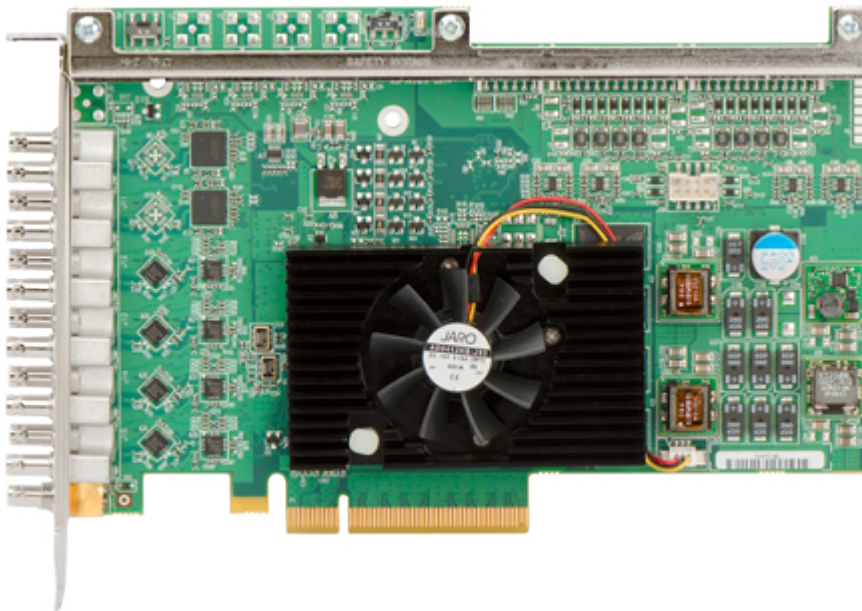

Matrox X.mio3 Overview

The X.mio3 can be ordered in two configurations: FH (full height, 12 physical HD-BNC connectors, plus one connector for sync) and LP (low profile, eight physical HD-BNC Connectors, plus one connector for sync). Both are half length PCI express Gen2 x8 cards.

- X.mio3FH (Full Height, half length) with up to 12 I/O ports, SD to 4K capable. This card can be ordered with six, eight or X2 (12) I/O. Eight ports are hardwired through relays: Four

inputs to four outputs. Model /6 means six I/Os are available, model /8 eight I/Os. Model X2 (twelve ports) has four freely configurable ports. There can be maximum eight I/Os of one type (either in or out) enabled on a card.

- X.mio3LP (Low Profile, half length) with up to eight I/O ports, SD to 4K capable.
- The I/O ports are configurable. This means that for instance the X.mio3 model /8 can be configured to have from 8/0 (e.g. 8 channels in, zero channels out) to 0/8 (zero channels in, eight channels out) or any mix between such 1/7, 4/4 and so on.
- One connector is reserved for a reference signal (sync) marked as REF.
The default card is an X.mio3/6/100, meaning X.mio3 FH with six connectors class 100. The class 100 can not play any video clips and upgrade to class 500 is required to enable both SD and HD clip playback. For Apple ProRes support, the class 550 is needed.

The I/O connectors for the X.mio3 are of the Mini-BNC (also called HD-BNC) type. The use of cable converters from Mini-BNC to BNC may be required.

The X.mio3 cards can be combined with the AES Audio Kit for 16 AES audio channels In/Out, see [X.mio3 AES Audio Kit](#).



X.mio3 FH

X.mio3 FH provides multichannel SDI IO with hardware based video processing in a full-height, half-length PCI express card with 13 physical HD-BNC connectors. This card provides up to 12 reconfigurable I/Os, from SD to 4K, one connector is reserved for sync. Support for AES/EBU, LTC and GPIO provide for versatile connectivity. The multi-channel hardware processing accelerates compute-intensive operations including motion-adaptive de-interlacing, up/down/cross scaling and mixing/compositing for all resolutions, including 4K.

Key features:

- Half-length PCI express card
- Re-configurable IO that can support up to 12 SDI IO
- Frame synchronizers
- VANC and HANC support for each input and output
- Analog black burst reference input (tri-level or bi-level)
- On-board multi-channel MADI (Motion Adaptive De-Interlacer)
- On-board multi-channel Up/Down/Cross scaler
- On-board multilayer compositor
- Automatic video relay bypass

- Live zero-frame delay video and audio mixers
- Up to 16 channels of AES/EBU inputs and outputs
- Up to eight LTC inputs and outputs
- RS422 control
- Single slot all inclusive option

⚠ IMPORTANT! Not all X.mio3 hardware features are supported by Viz Engine. Features available depends on drivers, SDK and Engine versions in use.

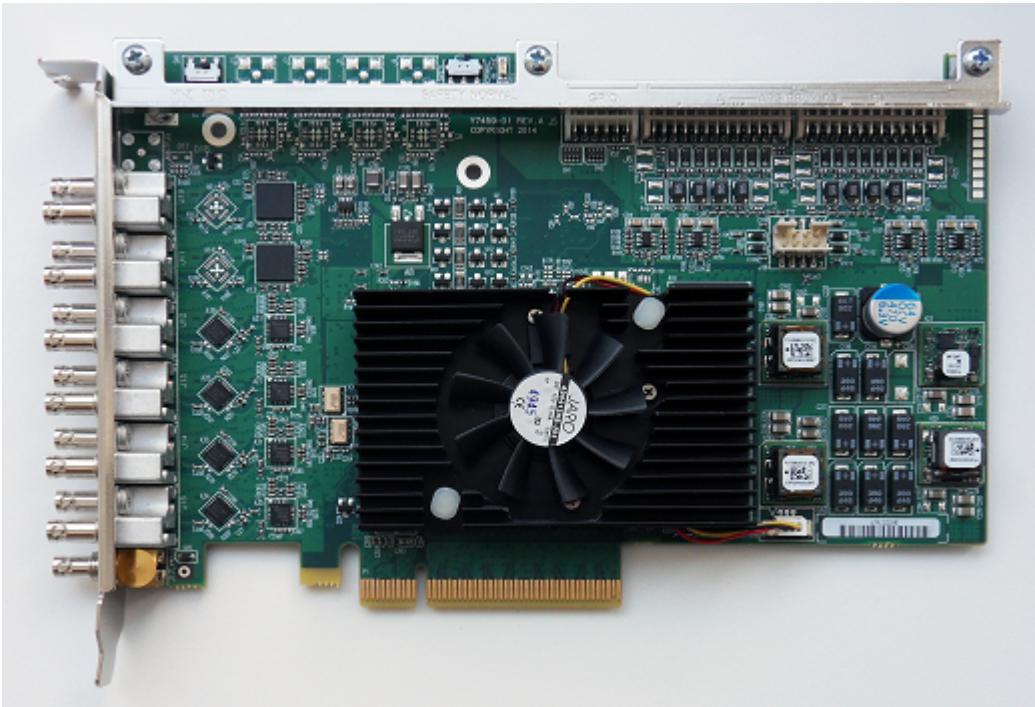

X.mio3 LP

Matrox X.mio3 LP is a low-profile, half-length PCIe card with up to eight reconfigurable SDI I/Os from SD to 4K.

Key Features

- Low profile, half-length PCI-e card.
- Re-configurable I/O that can support up to eight SDI inputs or outputs.
- Frame synchronizers.
- VANC and HANC support for each input and output.
- Analog black burst reference input (tri-level or bi-level).
- On-board multi-channel MADI (Motion Adaptive De-Interlacer).
- On-board multi-channel Up/Down/Cross scaler.
- On-board multilayer compositor.
- Automatic video relay bypass (optional).
- Live zero-frame delay video and audio mixer.

IMPORTANT! Not all X.mio3 hardware features are supported by Viz Engine. Features available depends on drivers, SDK and Engine versions in use.

The X.mio3 LP models are: /4, /6, /8 - corresponding to the number of I/O port the configuration supports.

X.mio3 Connector Mapping Reference

This section is a reference for X.mio3 connector mappings.

Upgrades and firmware setup of I/O mapping should be done by Vizrt or a qualified technician.

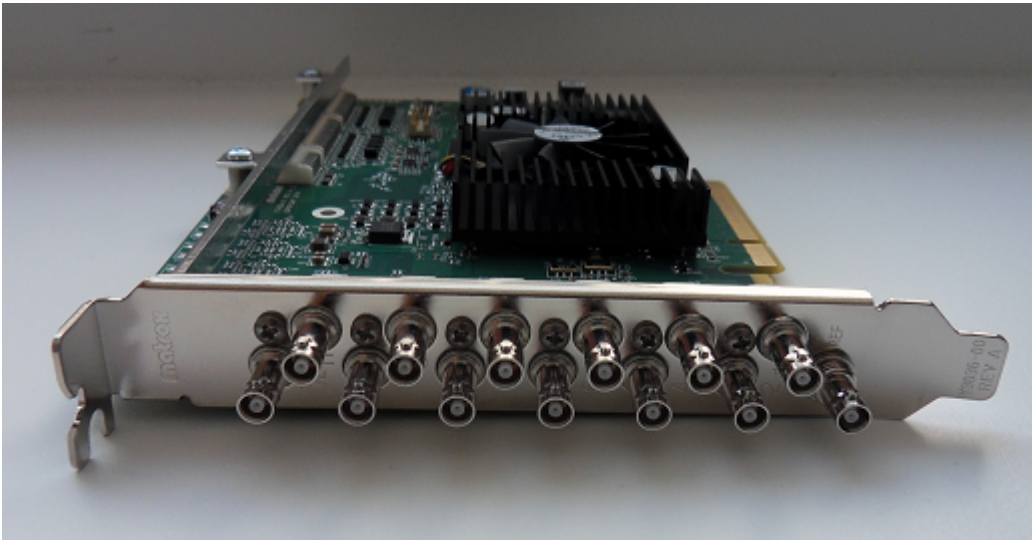

The X.mio3 connectors are labeled 1 through 12 (plus one connector for sync), eight connectors for the LP (low profile) card. As explained, the connectors can be configured for in or out and with various capabilities for clip playback depending on class - with possibilities for firmware class upgrades.

IMPORTANT! There can be maximum 8 ports of the same type (either in or out), this restriction also applies to the model x2 that has 12 connectors.

Connectors 1,3,5,7 are always reserved for **input**, connectors 2,4,6,8 for **output**. Hence, if the Watchdog is active port 1 (in) goes to port 2 (out) with relay, port 3 (in) to port 4(out) and so on.

The x2 model can as mentioned only have eight I/Os of the same type; 8in - 4out or 4in - 8out.

To configure the X.mio3 card for usage:

- Make sure that the card has the required mix of inputs and outputs required for the intended usage, for instance to satisfy fill, key, full-screen graphics requirements. This is done, if required, with the `mvConnectorConfig.exe` utility described in [X.mio3 I/O Port Configuration](#).
- Map the I/Os from step 1 above to the Viz Video channels using the Viz Engine Configuration utility. This is mostly the same procedure for X.mio3 as for previous Matrox cards, see [Viz Engine Matrox Video Mapping Configuration](#).

X.mio3 I/O Port Configuration

Normally the I/O ports are pre-configured when delivered from Vizrt. If the I/O configuration needs to be changed, the Matrox command-line utility `mvConnectorConfig.exe` normally found in

```
C:\Program Files\Matrox DSX.utils\drivers\mvConnectorConfig.exe
```

must be used. `mvConnectorConfig.exe` can be called from the command prompt without options to get a helpful usage message. To configure all X.mio3 cards in a system to use four inputs and two outputs the syntax is:

```
C:\Program Files\Matrox DSX.utils\drivers\mvConnectorConfig.exe -4in2out
```

To configure six outputs and no inputs the syntax is:

```
C:\Program Files\Matrox DSX.utils\drivers\mvConnectorConfig.exe -0in6out
```

and so on for the various I/O possibilities.

The computer should be stable with low load and no Viz programs running when using the configuration utility. Never interrupt a firmware upgrade. After making changes to the Matrox I/O configuration, the computer must be re-started with a complete power off.

 **Note:** Only even combinations are supported (e.g. an eight connector board can be configured as 80, 62, 44, 26 or 08).

Viz Engine Matrox Video Mapping Configuration

Open **Viz Configuration > Matrox** to configure the Matrox video channel mapping and mapping type.

The Viz video inputs are named alphabetically and limited to the number of available I/O channels the system has. The number in parenthesis indicates which channel is being used for fill and key. If you do not need a key signal in the output, de-select the **Key > Contains Alpha** option to make the I/O channel available for other usages. Example configuration:

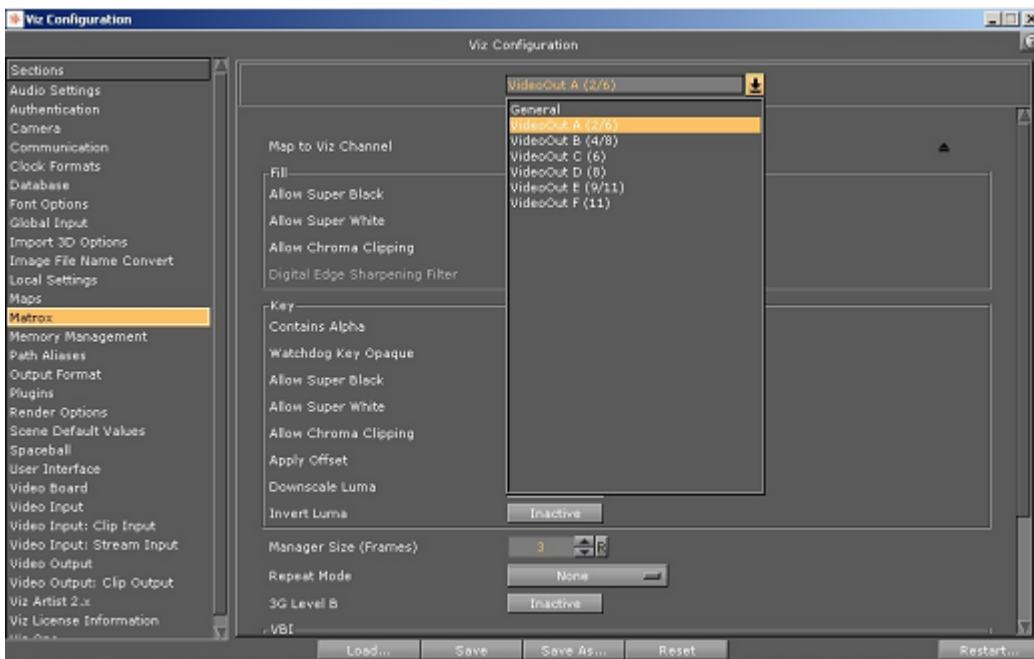

In the example above, the X.mio3 card is configured with 6 outputs (named **VideoOut A** to **F**) and no inputs. The numbers within the trailing parentheses reflect which IO-channel is being used for fill and key, respectively. This means **VideoOut A** uses IO-channel 2 for fill and IO 6 for key, **VideoOut B** uses IO 4 for fill, IO 8 for key, while **VideoOut C** only has fill using IO 6, and so on.

Navigate to **Config > Matrox > General** for an overview showing which I/O channels are used for fill and key, as illustrated in the **Board Info** section of the screenshot below:

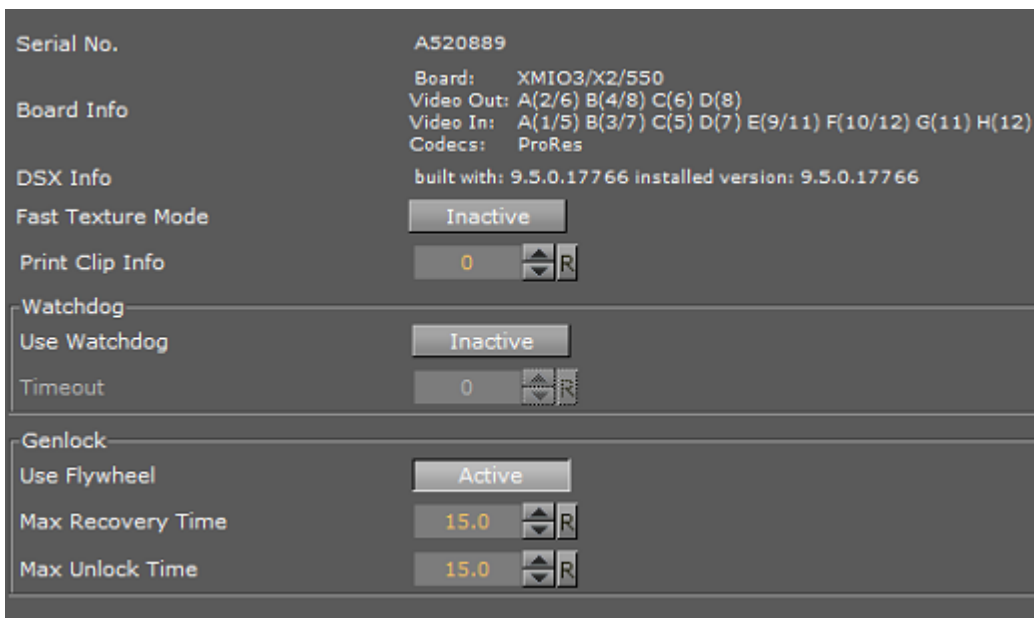

To Upgrade X.mio3 Class and Firmware

To upgrade your X.mio3 card, for example to enable more IO-ports or a codec upgrade for HD-Clipback, you must use the *mvDongleUpdater.exe* update utility with your Vizrt supplied license

upgrade file *<filename>.OPT*. This utility is installed with the Matrox driver package and is normally installed to:

```
C:\Program Files\Programs\Matrox DSK.utils\drivers\mvDongleUpdater.exe
```

To upgrade the card use this syntax:

```
C:\Program Files\Matrox DSX.utils\drivers\mvDongleUpdater.exe upgrade -
sn="SerialNumberofthecard" -f="Path to the upgrade file"
```

The command above must be run from a Windows command line window (**Windows-button > cmd > Enter**).

The Matrox [X.info](#) utility is used to display information about the card class, how the Input and Outputs are configured, serial number and more. This utility can normally be started from the Windows taskbar. A typical information window would be:

X.mio3 AES Audio Kit

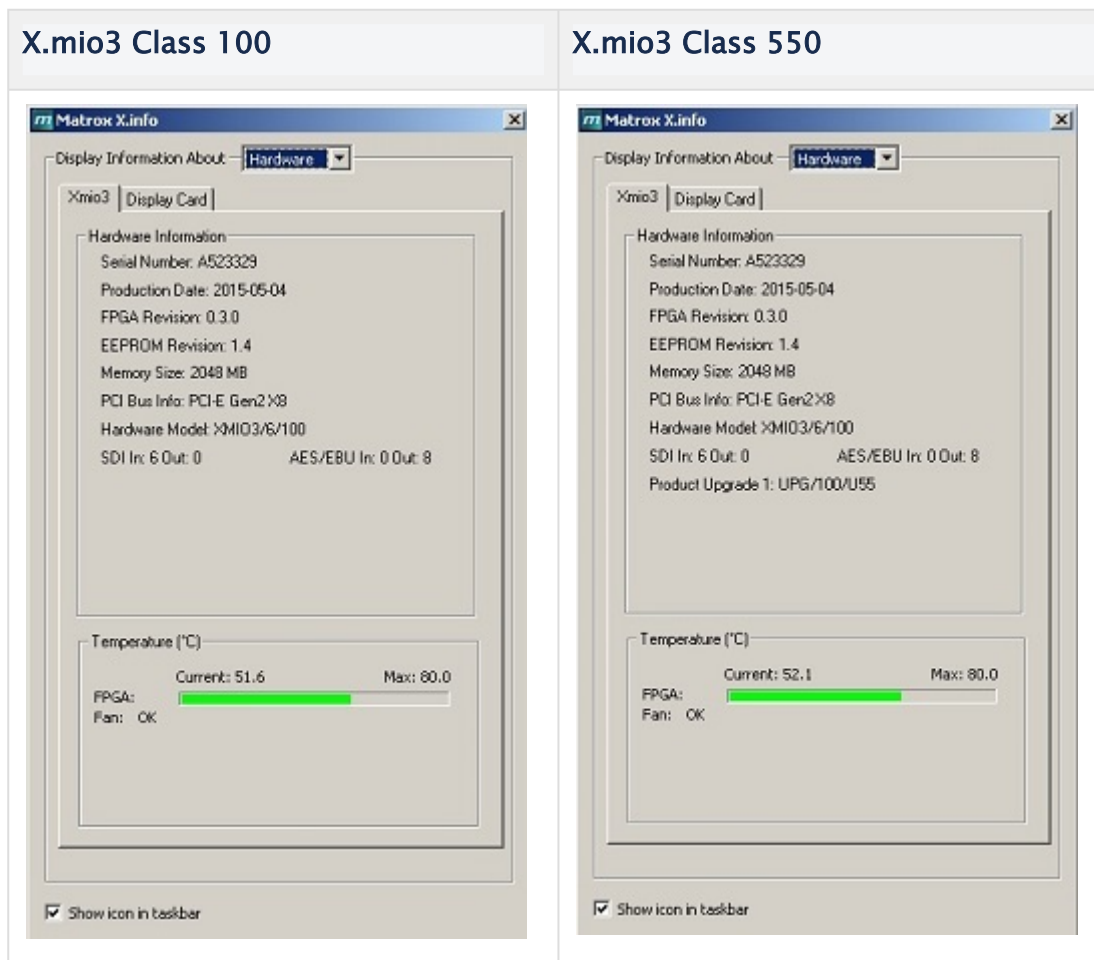

The X.mio3 AES Audio Kit connects to the X.mio3 card internally and takes up one slot as indicated in the picture below:

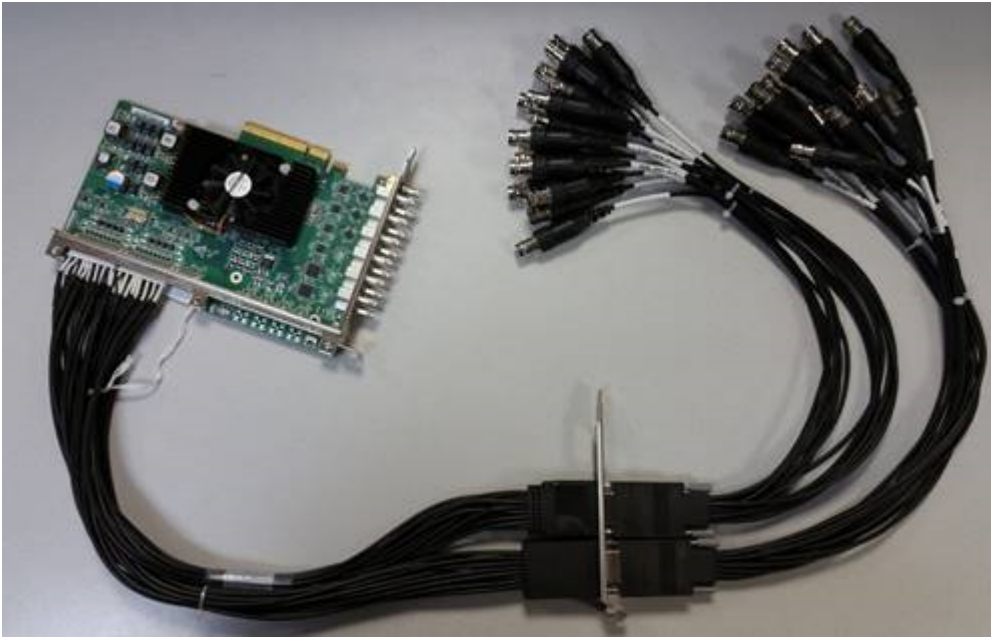

The kit contains:

- Two internal cables with bracket.
- Two external cables, each cable has:
 - Eight AES/EBU in and eight AES/EBU out (total 16 AES/EBU in and out).
 - Four LTC in and four LTC out (total eight LTC in and out).

Matrox X.mio2 and X.mio2 Plus

This section contains information on the following topics:

- [X.mio2 and X.mio2 Plus Cables and Connectors](#)
- [X.mio2 Standard Cable Configuration](#)
 - [Viz Engine Single Channel Configuration](#)
 - [Dual Channel Configuration](#)
 - [Trio Box CG/Viz Trio OneBox Configuration](#)
- [Breakout Cables and Connectors](#)
 - [Video Cables for X.mio Series](#)
 - [Video Connectors for X.mio2 Plus](#)
 - [Video Connectors for X.mio2](#)
 - [Video Connectors for X.mio](#)
 - [Audio Connectors for X.mio2 and 2 Plus](#)
 - [Audio Connectors for X.mio](#)
- [Video Cable Assignment](#)
- [Audio-extension Card](#)
 - [To Connect the Audio-extension Card to the Video Board](#)
 - [To Remove the Audio-extension Card Back-end](#)
- [X.mio2 License Upgrade](#)
 - [To Generate a Matrox Dongle Information File \(.MDIF\)](#)

- [To Upgrade with a Matrox Dongle Upgrade File \(.MDUF\)](#)
- [To Reset to Factory Settings](#)



X.mio2 and X.mio2 Plus Cables and Connectors

The connectors for X.mio2 and X.mio2 Plus are:

- PCIe board compliant to PCIe 2.0 in x8 or x16 slot
- x2 or x4 SDI video inputs in SD and HD
- x4 SDI video outputs in SD and HD
- x16 In / x32 Out, unbalanced AES/EBU audio

Because of the large number of I/O connections, the X.mio2 and X.mio2 Plus boards are equipped with Sub-D connectors. A breakout-cable or rack mountable Break Out Box (BOB), which translates the Sub-D connectors to regular connectors/plugs, is included for every machine.

The connectors for X.mio are:

- 133 MHz PCI-X board compliant to PCI-X standards 1.0b and 2.0
- x2 SDI video inputs in SD and HD
- x4 SDI video outputs in SD and HD
- x8 In / x16 Out, balanced XLR AES/EBU audio
- x16 Embedded Audio I/O Channels per SDI Stream

X.mio2 Standard Cable Configuration

This section contains the standard configuration, set in the in the Viz Configuration, to cable a Viz Engine to the correct SDI IN and OUT connectors.

Viz Engine Single Channel Configuration

- SDI OUT A: mapped to Program Fill
- SDI OUT C/KEY: mapped to Program Key
- SDI OUT B: mapped to Preview Fill
- SDI OUT D/KEY: mapped to Preview Key
- SDI IN A: mapped to Video1
- SDI IN B/KEY: mapped to Video2, and so on

Dual Channel Configuration

A Viz Engine configured as Dual Channel utilizes two graphics cards and runs two instances of the Engine on a single computer. When running a Dual Channel setup, video inputs are hardware resources on the Matrox board that can not be shared. If one input for both Viz Engine channels is required, split the signal and apply it to the two video input connectors. Each Matrox video input can only be mapped in one Viz Engine instance and has to be set to unused in the other instance.

- **Channel 1:**
 - SDI OUT A: mapped to Program Fill
 - SDI OUT C/KEY: mapped to Program Key
 - SDI IN A: mapped to Video1 for the first channel
 - SDI IN B/KEY: unused for the first channel, and so on.
- **Channel 2:**
 - SDI OUT B: mapped to Program Fill
 - SDI OUT D/KEY: mapped to Program Key
 - SDI IN A: unused for the second channel
 - SDI IN B/KEY: mapped to Video1 for the second channel, and so on

 **IMPORTANT!** Both Viz Engines must be set to the same genlock setting.

Trio Box CG/Viz Trio OneBox Configuration

- **Program:**
 - SDI Out A: mapped to Fill
 - SDI OUT C/KEY: mapped to Key
 - SDI IN A: mapped to Video1
 - SDI IN B/KEY: mapped to Video2, and so on.
- **Preview:**
 - SDI Out B: mapped to Fill
 - SDI OUT D/KEY: mapped to Key
 - No Inputs are mapped by default

Breakout Cables and Connectors

A Breakout Box (BOB) is often used for Viz Engine solutions that need to be rewired in regular intervals. The 1U Rack unit chassis is designed to fit into a standard 19" rack.



Video Cables For X.mio Series

This image shows the cables responsible for transmitting any video related signals to and from the X.mio2 Plus board.



Video Connectors For X.mio2 Plus

The front panel of the X.mio2 Plus breakout box provides the user with eight or nine standard BNC connectors.

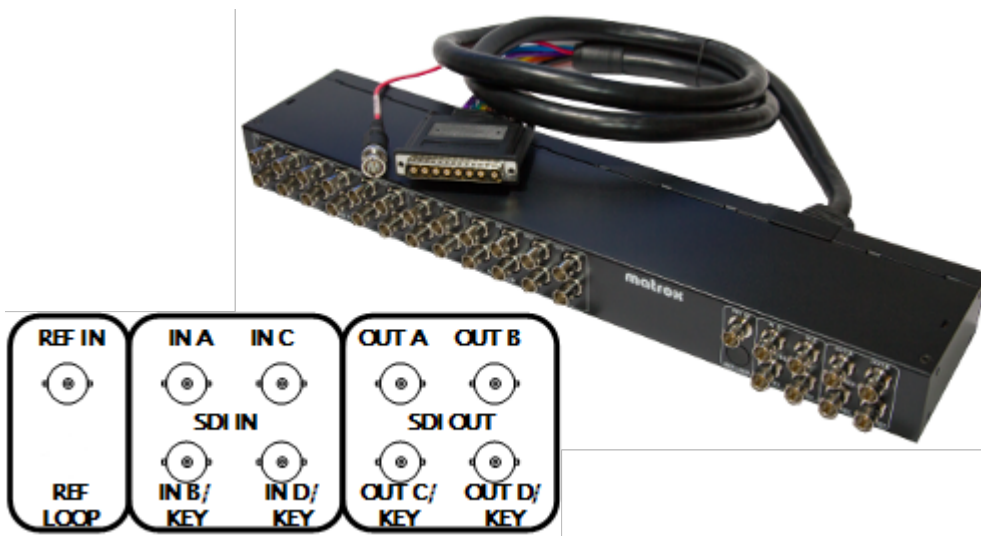

- x2 or x4 HD/SD SDI In
- x4 HD/SD SDI Out
- x1 Analogue Ref In

Video Connectors For X.mio2

The front panel of the X.mio2/2 Plus breakout box provides the user with eight or ten standard BNC connectors.

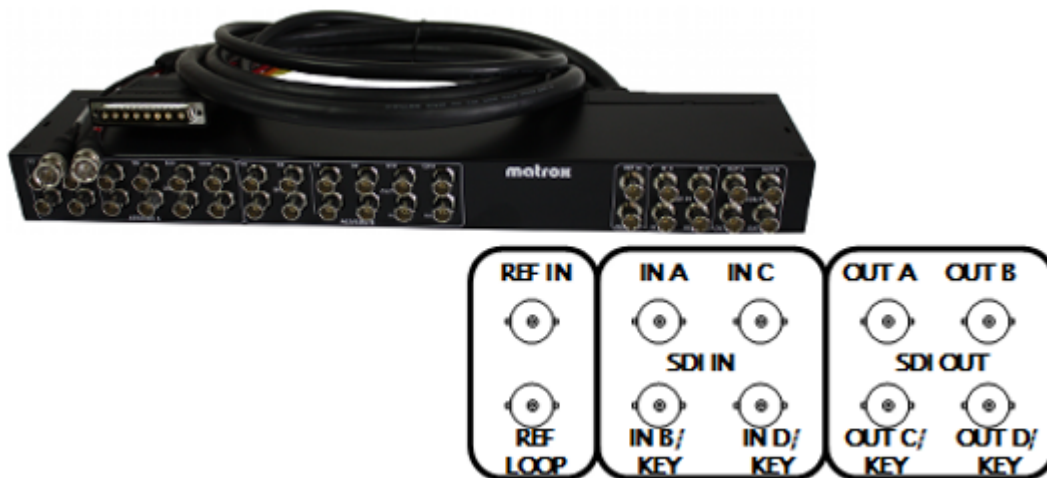

- x2 or x4 HD/SD SDI In
- x4 HD/SD SDI Out
- x1 Analogue REF IN
- x1 Analogue REF LOOP

⚠ IMPORTANT! When using the REF IN connector on the Matrox X.mio2 board for synchronization, the REF LOOP connector must be terminated with a 75 Ohm resistor unless it is being used to loop an incoming Genlock signal.

Video Connectors For X.mio

The front panel of the X.mio breakout box provides the user with eight standard BNC connectors.



- x2 HD/SD SDI In
- x4 HD/SD SDI Out
- x1 Analogue REF IN
- x1 Analogue REF LOOP

⚠ IMPORTANT! When using the Ref. In connector on the Matrox X.mio board for synchronization, the Ref. Out Loop connector must be terminated with a 75 Ohm resistor unless it is being used to loop an incoming Genlock signal.

Audio Connectors For X.mio2 And 2 Plus

On the X.mio2/2 Plus breakout box, each of the two audio bays, A and B, consists of four female BNC audio input channels and of eight female BNC audio output channels.

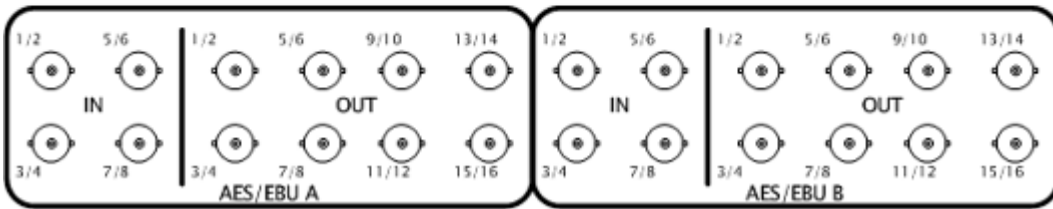

Note: Bay cables are not included.

On the backside of each breakout box there are two connectors labeled AUDIO-A and AUDIO-B. The included cables are used to connect the corresponding plugs of the X.mio series to the computer.

Audio Connectors For X.mio

The front side of the X.mio breakout box hosts various audio in- and outputs. Each of the two audio bays, A and B, consists of two female AES/EBU audio input channels and of four male AES/EBU audio output channels.

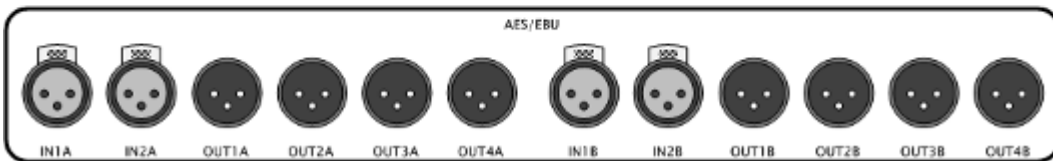

Video Cable Assignment

Connect the relevant video input(s) and output(s), and the reference signal(s) as per the labels attached to each cable. A reference signal can be attached to the reference input connector **ANALOG REF IN**, which can be fed with any analogue Genlock signal, such as a black burst or Tri-level as required. If the reference signal used for synchronization is relayed from a Matrox X.mio and X.mio2 to a graphics card, make sure to check that all internal connections

between the graphics card and its SDI extension are connected correctly, and that the extension is correctly supplied with power.

When the **ANALOG REF IN** connector is used with a Matrox X.mio or X.mio2 board for synchronization, the **ANALOG REF LOOP OUT** connector must be terminated with a 75 Ohm resistor unless it is being used to loop an incoming Genlock signal. The **ANALOG REF LOOP OUT** for the X.mio2 Plus is terminated by default, and so only supports REF IN on the actual board.

Audio-extension Card

The audio-extension card and audio cables are part of the X.mio series break-out box or the X.mio series cable kit (that comes with the X.mio series boards), and needs to be installed when AES/EBU audio support is required. The card is an extension for the connectors, and does not provide any extra functionality. For installations that require embedded audio, or no audio at all, this extension is not required.



IMPORTANT! The Matrox audio-extension card only supports digital audio.

By default, the audio-extension card consumes one additional free slot on the motherboard. The card is supplied with the Matrox X.mio series boards in terms of power and data.

In some cases, the design of the audio-extension card makes it hard to mount it at a location with an underlying PCIe slot. Therefore, it is an option to remove the back-end from the Audio-extension Card instead of using another PCI or PCI-X slot. However, it is in most cases possible to mount the extension card in any slot in the machine, unrelated to the underlying slot's design, without removing its back-end.

Removing the back-end of the extension card frees any connection to the motherboard. As a result, it may react more sensitively to transportation and tension introduced by the external audio cables connected to it. Therefore, the above-mentioned procedure should only be applied to machines residing in stable environments like a dedicated machine room. Do not apply these instructions to machines intended to be used for outside broadcasting or equipment that are moved around a lot.

To Connect The Audio-Extension Card To The Video Board

IMPORTANT! The Matrox audio-extension card only supports digital audio.

1. Locate the connectors on the audio-extension card labeled A and B.

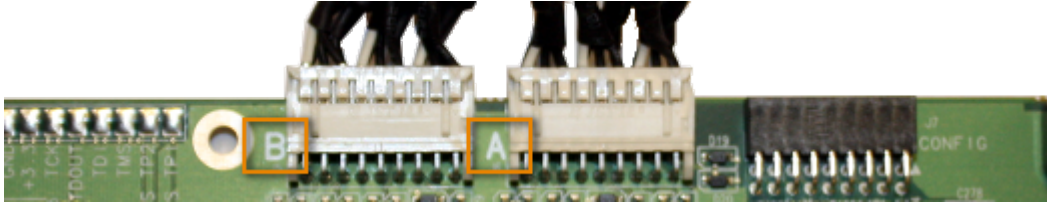

2. Locate the connectors on the video board labeled A and B.
3. Use the cables to connect A on the audio-extension card to A on the video board, and do the same for the B connectors.

To Remove The Audio-Extension Card Back-End

1. Locate the audio-extension card's weak spots

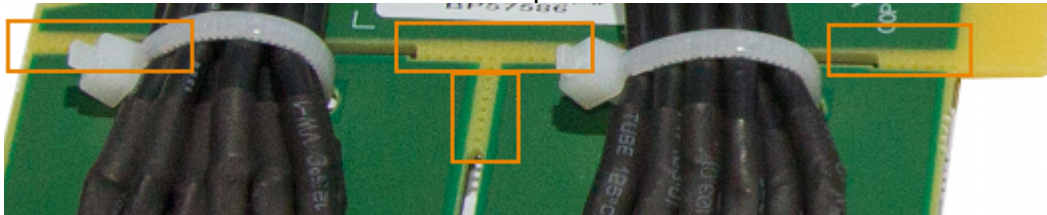

2. Carefully break the connections.

⚠ Caution: Do not break the weak spots that hold the two remaining pieces together.

X.mio2 License Upgrade

The Matrox X.mio2 and X.mio2 Plus boards include all SD codecs except D10 Television/D12 Television. These two boards can be upgraded to any higher class by a license upgrade. To do this, use the Matrox [X.info](#) utility. To upgrade a video board to a higher class, it is necessary to generate a Matrox Dongle Information File (.MDIF), and then upgrade with a Matrox Dongle Upgrade File (.MDUF). It is also possible to reset to factory settings at any time.

The X.mio2 Plus board video inputs can also be upgraded from two to four.

⚠ Note: Driver versions older than 4.0.0-126 do not support the upgrade and revert features.

To Generate A Matrox Dongle Information File (.MDIF)

1. Open the Matrox [X.info](#) utility on the Windows taskbar.
2. Select **Hardware**, and click the **Upgrade Model** button on the right.
3. From the appearing menu, choose **Generate Matrox Dongle Information File (.MDIF)**.
4. Select to save the file to a specified location.
5. Once the file is created, a confirmation dialog box appears.
6. Click **OK** to dismiss the confirmation dialog box.
7. Locate the file and send it to your local Vizrt representative (to find the local Vizrt customer support team, please visit www.vizrt.com). Once the request to purchase an upgrade has been sent, an MDUF file is sent in return from Vizrt.

To Upgrade With A Matrox Dongle Upgrade File (.MDUF)

1. Open the Matrox [X.info](#) utility on the Windows taskbar.
2. Select **Hardware**, and click the **Upgrade Model** button on the right.
3. From the appearing menu, choose **Upgrade Board from Matrox Dongle Upgrade File (.MDUF)**.
4. Click **Browse** to locate and select the .MDUF file to start the upgrade process.
5. Restart the machine for the changes to take effect.

To Reset To Factory Settings

1. Open the Matrox [X.info](#) utility on the Windows taskbar.
2. Select **Hardware**, and click the **Upgrade Model** button on the right.
3. From the appearing menu, choose **Reset to Factory Settings**.
4. Restart the machine for the changes to take effect.

Matrox M264 S1 /S2/S3

Matrox M264 cards feature hardware-based H.264 encoding and decoding capabilities. Depending on the card used, up to three UHD XAVC streams can be encoded/decoded simultaneously.

VizEngine as well as ChannelRecorder are capable of using the M264 cards for playback and capture of XAVC material, without affecting CPU performance.



Key Features

- PCI Express Cards
- H.264 video encoding and decoding
- UHD resolution support
- 4:2:2 10-bit
- Sony XAVC compliant encoding including 4K XAVC Long and 4K Intra Class 480
- Panasonic AVC-Ultra compliant

Performance for 4:2:2 10-bit Streams for M264

Resolutions	Structure	Format	Number of streams
2160p	I-frame	XAVC Class 300 & Class 480 / AVC-Intra 4K	1
1080p	I-frame	XAVC Class 200 / AVC-Intra 200	3
1080i	I-frame	XAVC Class 100 / AVC-Intra 100	10
2160p	Long GOP	Generic / XAVC 4K Long	1
1080p	Long GOP	Generic / XAVC Long50 / AVC-LongG50	5
1080i	Long GOP	Generic / XAVC Long25 / AVC-LongG25	10
720p	Long GOP	Generic / XAVC Long25 / AVC-LongG25	10

Note: The models S2 and S3 host (respectively) two and three encoder/decoder chips, so the number of possible streams is doubled/tripled.

M264 configuration

VizEngine

To enable VizEngine to use M264 cards, the serial number of the M264 needs to be added to the configuration file after the serial number of the installed X.mio3 or DSX LE 4 card.

```
Matrox.Devices = A123456,A654321
```

ChannelRecorder

ChannelRecorder detects any installed M264 card automatically and uses it for encoding, when the XAVC UHD codec is used. No further configuration is necessary.

Note: GPU Direct currently is not supported in combination with M264 hardware.

Matrox DSX LE3 Series

Viz Engine supports the Matrox DSX LE series, versions 3 and 4. The DSX LE series cards were initially introduced as an entry level video card, for installations where no compositor is required. It has since been expanded with some card models that also feature a compositor less feature-rich and advanced than those found on the X.mio series cards.

The main features of the DSX LE series video boards are:

- The DSX LE4 is a passively cooled video card featuring HD-BNC connectors and video clip playback capabilities
 - The DSX LE3/**/100 does not have video clip playback capabilities. To play video clips (SD and HD) as Texture, upgrade from 100 to 500, or 550 to include support for Apple ProRes.
 - The standard Matrox DSX LE3 does not provide DVE capabilities or other high-end features, such as frame synchronizers on the input or advanced failsafe capabilities.
- On Boards with no on-board compositor, the software compositor is activated by default. The output of the fill signal differs between the software compositor and the hardware compositor. Although the results are the same when looking at them after a keyer, to get the desired result, set the flag `use_compositor` in the configuration file to 0.

This section describes the following information:

- [Cables and Connectors](#)
- [Breakout Cables and Connectors](#)
- [Video Cable Assignment](#)
- [Audio Cable Assignment](#)
 - [AES Input Cable Assignment](#)
 - [AES Output Cable Assignment](#)
 - [Embedded Input](#)
 - [Embedded Output](#)

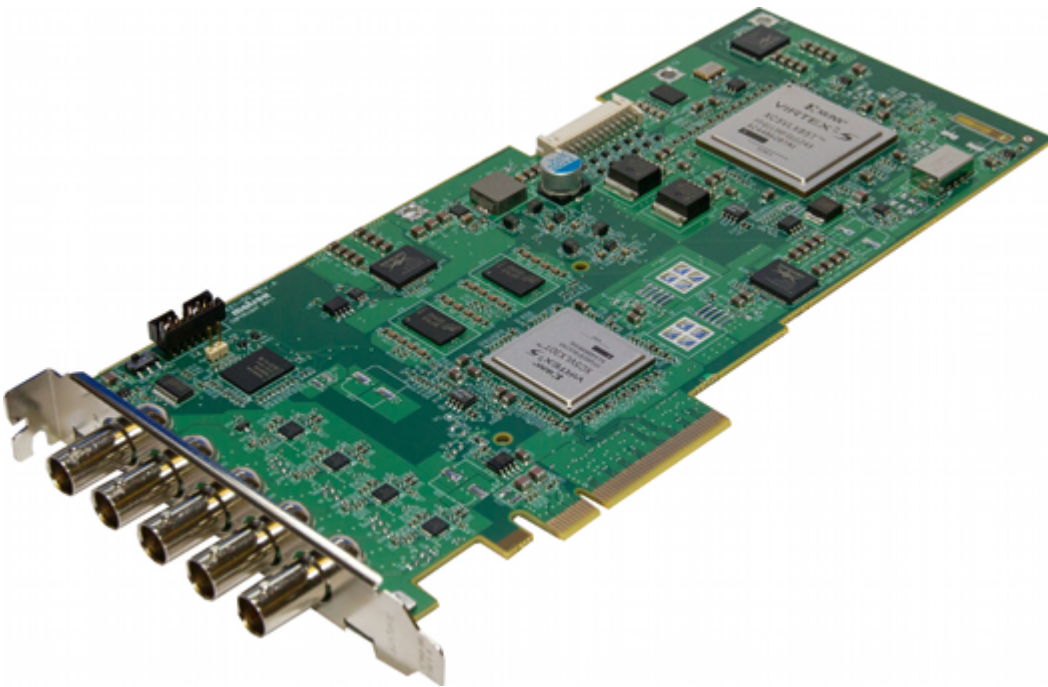

Cables and Connectors

The connectors for DSX LE3 are:

- PCIe board compliant to PCIe 2.0 in x8 or x16 slot.
- x4 SDI video outputs in SD and HD.

- x16 Embedded Audio I/O Channels per SDI Stream.
The board comes with an additional card and break-out cables for AES audio. Fill and key signals as well as reference signals, or Genlock, have their own BNC connectors. The board should be installed in the same slot as the X.mio2/2 Plus board, and uses the same driver versions as Matrox X.mio2/2 Plus.

Breakout Cables and Connectors

The DSX LE3 come with a set of breakout cables, and thus do not require any breakout box.

The breakout cable is used for the reference signal, or Genlock, and AES output. Fill and key signals have their own BNC connectors. Both boards should be installed in the same slot as the X.mio2/2Plus board. The DSX-series video cards only support embedded audio, and do not support audio-extension cards for AES input.

Video Cable Assignment

Matrox DSX LE4, LE3 and DSX LE2/CG all have HD capabilities. The DSX.LE3 has four video output connectors.

The four video output connectors for the DSX.LE3 gives you two pairs of fill and key, where output A and B are Fill and output C and D are Key, respectively.

Audio Cable Assignment

AES Input Cable Assignment

Card	Viz Audio Config	AES Cable	Matrox Video Channel
DSX.LE3	2 tracks	Not supported	
	4 tracks	Not supported	
	8 tracks	Not supported	
	16 tracks	Not supported	

AES Output Cable Assignment

Card	Viz Audio Config	AES Cable	Matrox Video Channel
DSX.LE3	2 tracks	AES OUT 1/2	Video Out 0
	4 tracks	AES OUT 1/2+3/4	Video Out 0
	8 tracks	AES OUT 1/2+3/4+5/6+7/8	Video Out 0

Card	Viz Audio Config	AES Cable	Matrox Video Channel
	16 tracks	Not supported	

Embedded Input

Card/Viz Audio Config	2 tracks	4 tracks	8 tracks	16 tracks
DSX.LE3	-	-	-	-

Embedded Output

Card/Viz Audio Config	2 tracks	4 tracks	8 tracks	16 tracks
DSX.LE3	yes	yes	yes	yes

Matrox X.RIO

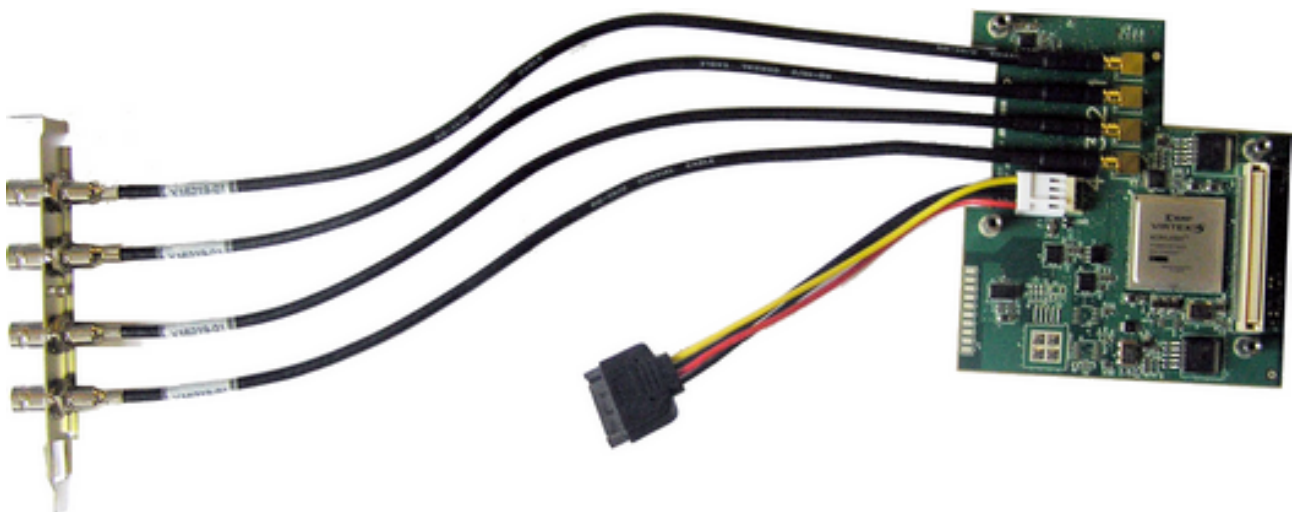

Matrox X.RIO is an expansion module for the Matrox X.mio2 board that provides four configurable I/Os. With the Matrox X.mio2 and X.RIO combined, Viz Engine supports up to eight video inputs. The use of eight inputs requires an upgrade of the X.mio2, which in most cases ships with two inputs and four outputs. Support for the Matrox X.RIO expansion module started with Viz Engine 3.5.

This section contains information on the following topics:

- [Cables and Connectors](#)
 - [Breakout Cables and Connectors](#)
 - [Video Cable Assignment](#)
 - [Audio Cable Assignment](#)
- [Install and Configure the Matrox X.RIO](#)

- [To Install the Matrox X.RIO Expansion Module](#)
- [To Configure the Matrox X.RIO Board](#)

Cables and Connectors

As the X.RIO module expands the capabilities of the Matrox X.mio2-based systems providing four extra inputs you are able to have four key and four fill inputs and two key and two fill outputs.

 **Note:** The extra connectors can only be used as four extra inputs, they cannot be used as outputs.

With an HP Z800 machine, Matrox X.mio2 and X.RIO, the following is possible: with SD, eight inputs are working as DVE or Texture, whereas with HD, six inputs are working as DVE (at approximately 65%) or Texture.

 **Note:** The actual number of working inputs depend on the bandwidth of the system, resource usage, how many clips are played at the same time, and if they are played as DVE or Texture.

Breakout Cables And Connectors

All breakout cable assignments are handled by the X.mio2 board and its breakout box, see the Matrox X.mio Series section.

Video Cable Assignment

All video cable assignments are handled by the X.mio2 board, see the Matrox X.mio Series section.

Audio Cable Assignment

All audio cable assignments are handled by the X.mio2 board, see the Audio Cable Assignment.

Install and Configure the Matrox X.RIO

To Install The Matrox X.RIO Expansion Module

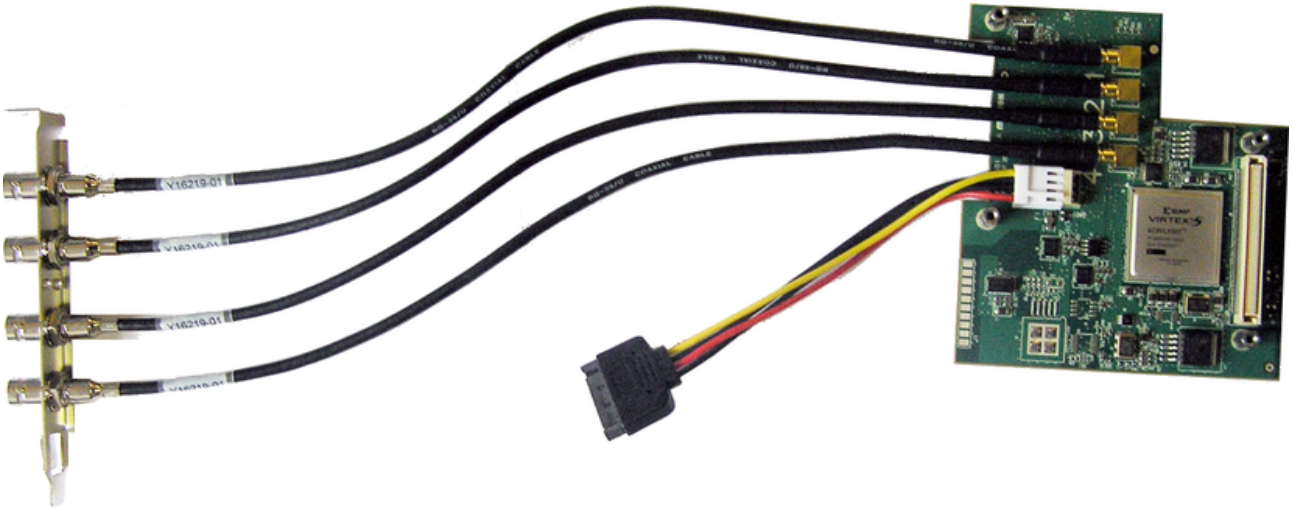

1. Connect the power cable to the X.RIO.
2. The slot panel has numbers from 1-4. Make sure to connect them carefully, as the mini-BNCs can break easily.

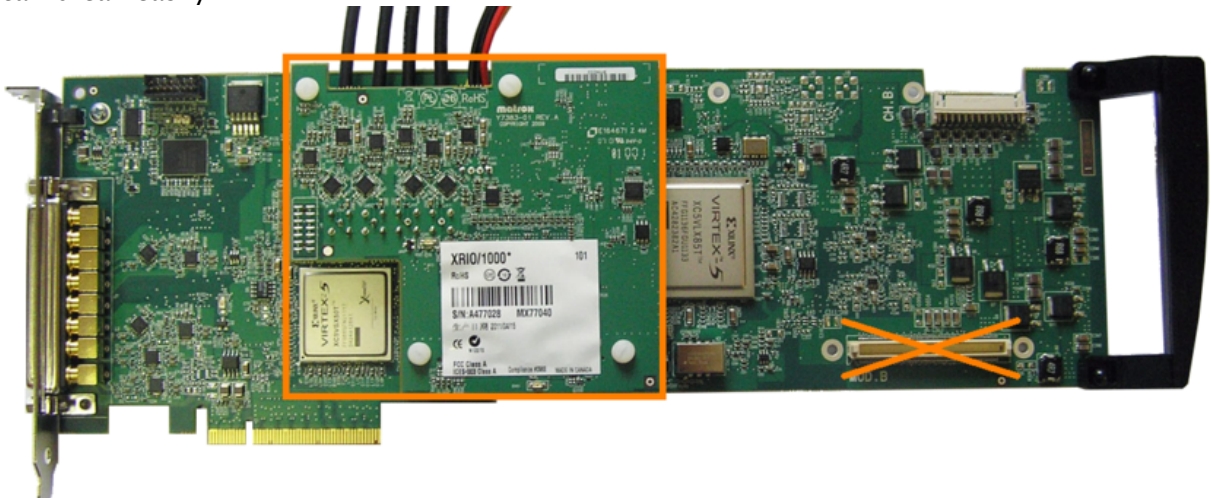

3. Mount the X.RIO on the X.mio2 board "Mod A" connector. The Mod B connector does not work.
4. Use the screws to fix the X.RIO expansion module.

✔ **Tip:** When installing an X.mio2 with X.RIO into a HP Z800, make sure that the mini-BNCs do not get disconnected during installation, as they are very hard to connect while the X.RIO board is mounted on the X.mio2.

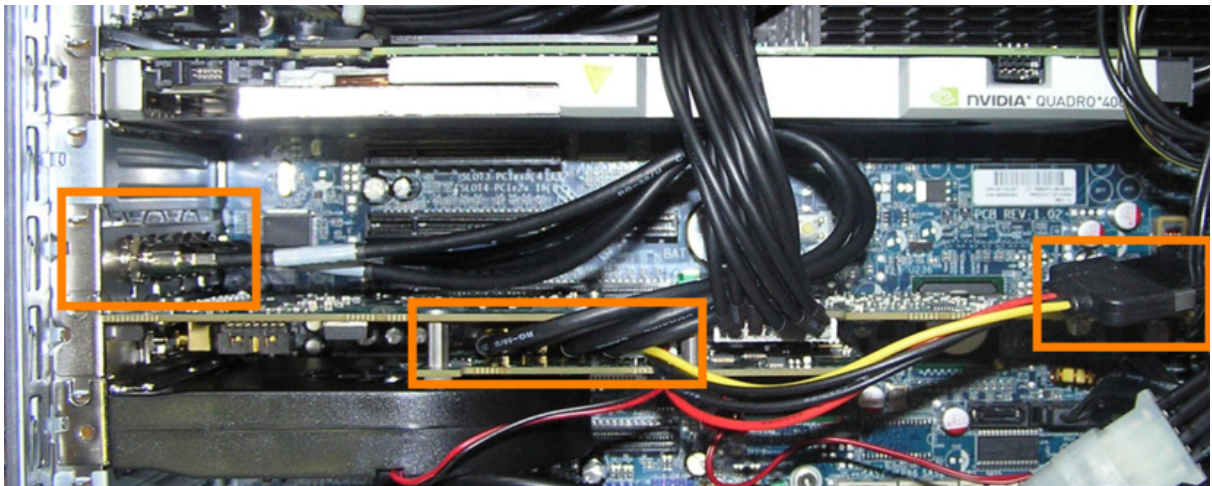

5. Mount the slot panel with the 4 additional inputs in any free slot and connect the power for the X.RIO. Also, make sure the cables is not in touch with any fans.

To Configure The Matrox X.RIO Board

1. Install the Matrox driver.
2. Start Matrox X.Info.
3. Under the X.mio2 /24 Card tab select the Hardware option, to enable the X.RIO Configure button.
4. In the X.RIO Module Configuration dialog-box check that the configuration for next restart is set to four Inputs and zero Outputs.
5. Restart the computer.
6. Start Viz Configuration, and go to the Matrox section. From the drop-down menu, the VideoIn parameters, for example E, F, G and H, can be configured. Note that the X.RIO inputs are mapped to Viz Engine's channels 5-8 by default. This means that when an X.mio2/24 is in use, Viz Engine's channels 3 and 4 are not in use.

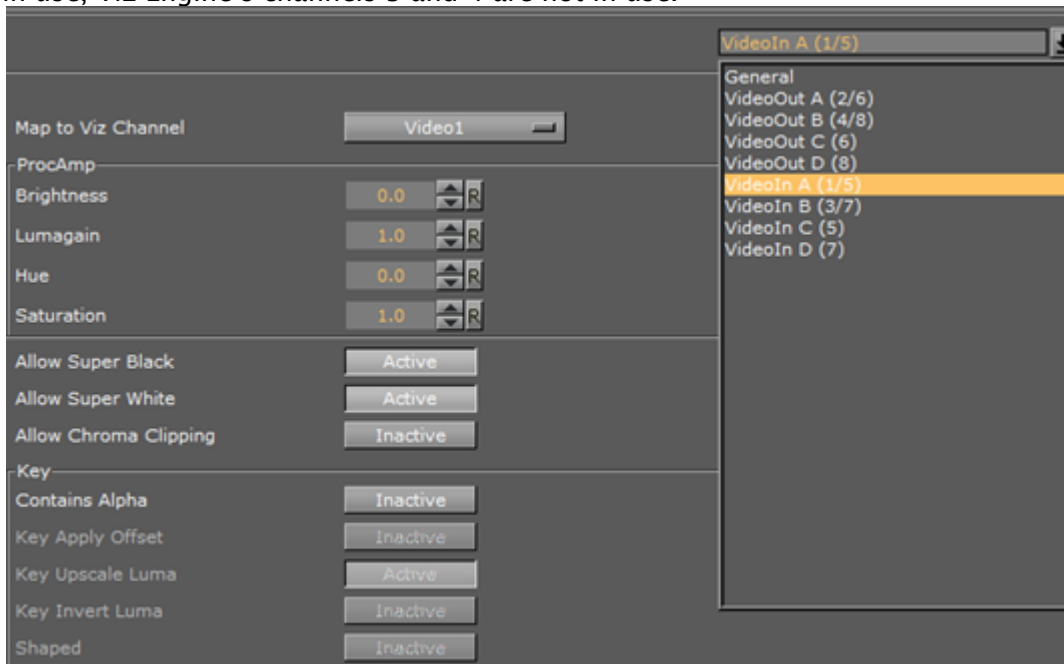

Matrox X.Open

Matrox X.Open is a PCI board with no video outputs or inputs that you find on a regular video board such as the Matrox X.mio Series, but it has support for all the same codecs as a typical Matrox board.

It is well suited for video clip playback using the Matrox clip player for IP, DVI as well as VGA output.

Note: The legacy XOpen dongle is no longer supported on Windows 10 due USB driver incompatibilities.

Audio Cable Assignment

This section contains information on the following topics:

- [AES Input Cable Assignment](#)
- [AES Output Cable Assignment](#)
- [Embedded Input](#)
- [Embedded Output](#)

AES Input Cable Assignment

Card	Viz Audio Config	AES Cable	Matrox Video Channel
X.mio3	2 tracks	A IN 1/2	Video IN A
		A IN 3/4	Video IN B
		A IN 5/6	Video IN C
		A IN 7/8	Video IN D
		B IN 1/2	Video IN E
		B IN 3/4	Video IN F
		B IN 5/6	Video IN G
		B IN 5/6	Video IN H
		A IN 1/2+3/4	Video IN A
4 tracks	4 tracks	A IN 1/2+3/4	Video IN A
		A IN 5/6+7/8	Video IN B
		B IN 1/2+3/4	Video IN C
		B IN 5/6+7/8	Video IN D
8 tracks	8 tracks	A IN 1/2+3/4+5/6+7/8	Video IN A
		B IN 1/2+3/4+5/6+7/8	Video IN B

Card	Viz Audio Config	AES Cable	Matrox Video Channel
	16 tracks	A IN 1/2+3/4+5/6+7/8 B IN 1/2+3/4+5/6+7/8	Video IN A
X.mio2, X.mio2 Plus	2 tracks	A IN 1/2 A IN 3/4 A IN 5/6 A IN 7/8	Video IN A Video IN B Video IN C Video IN D
	4 tracks	A IN 1/2+3/4 A IN 5/6+7/8 B IN 1/2+3/4 B IN 5/6+7/8	Video IN A Video IN B Video IN C Video IN D
	8 tracks	A IN 1/2+3/4+5/6+7/8 B IN 1/2+3/4+5/6+7/8	Video IN A or Video IN C Video IN B or Video IN D
	16 tracks	A IN 1/2+3/4+5/6+7/8 B IN 1/2+3/4+5/6+7/8	Video IN A, or Video IN B, or Video IN C, or Video IN D
X.mio	2 tracks	A IN 1 B IN 1	Video IN A Video IN B
	4 tracks	A IN 1+2 B IN 1+2	Video IN A Video IN B
	8 tracks	A IN 1+2 B IN 1+2	Video IN A
	16 tracks	Not supported	

AES Output Cable Assignment

Card	Viz Audio Config	AES Cable	Matrox Video Channel
X.mio3	2 tracks	A Out 1/2 A Out 3/4 A Out 5/6 A Out 7/8 B Out 1/2 B Out 3/4 B Out 5/6 B Out 7/8	Video Out A Video Out B Video Out C Video Out D Video Out E Video Out F Video Out G Video Out H
	4 tracks	A Out 1/2+3/4 A Out 5/6+7/8 B Out 1/2+3/4 B Out 5/6+7/8	Video Out A Video Out B Video Out C Video Out D
	8 tracks	A Out 1/2+3/4+5/6+7/8 B Out 1/2+3/4+5/6+7/8	Video Out A Video Out B
	16 tracks	A Out 1/2+3/4+5/6+7/8 B Out 1/2+3/4+5/6+7/8	Video Out A
X.mio2, X.mio2 Plus	2 tracks	A OUT 1/2 B OUT 1/2	Video Out 0 Video Out 1
	4 tracks	A OUT 1/2+3/4 B OUT 1/2+3/4	Video Out 0 Video Out 1
	8 tracks	A OUT 1/2+3/4+5/6+7/8 B OUT 1/2+3/4+5/6+7/8	Video Out 0 Video Out 1

Card	Viz Audio Config	AES Cable	Matrox Video Channel
	16 tracks	A OUT 1/2+3/4+5/6+7/8 +9/10+11/12+13/ +14+15/16 B OUT 1/2+3/4+5/6+7/8 +9/10+11/12+13/ +14+15/16	Video Out 0 Video Out 1
X.mio	2 tracks	A OUT 1 A OUT 3	Video Out 0 Video Out 1
	4 tracks	A OUT 1+2 A OUT 3+4	Video Out 0 Video Out 1
	8 tracks	A OUT 1+2 B OUT 1+2 A OUT 3+4 B OUT 3+4	Video Out 0 Video Out 1
	16 tracks	A OUT 1+2+3+4 B OUT 1+2+3+4	Video Out 0

Embedded Input

Card/Viz Audio Config	2 tracks	4 tracks	8 tracks	16 tracks
X.mio3	yes	yes	yes	yes
X.mio2 Plus	yes	yes	yes	yes
X.mio2	yes	yes	yes	yes
X.mio	yes	yes	yes	yes

Embedded Output

Card/Viz Audio Config	2 tracks	4 tracks	8 tracks	16 tracks
X.mio3	yes	yes	yes	yes

Card/Viz Audio Config	2 tracks	4 tracks	8 tracks	16 tracks
X.mio2 Plus	yes	yes	yes	yes
X.mio2	yes	yes	yes	yes
X.mio	yes	yes	yes	yes

Matrox Driver Installation

The first time a machine is started with a Matrox board or dongle installed, the operating system prompts the user to install the necessary Matrox drivers. Before installing a new driver, or upgrading the existing drivers, any currently installed drivers must be removed first. Please refer to the section To Remove the Matrox Driver for further information on how to remove any such drivers.

Important: On Windows 10 systems with Secure Boot enabled, it is required to install a special driver. Those drivers are labeled with an `_EV` in the filename, like `DSX.utils_EV.exe`

- The driver for all hardware bound installations is called `DSX.utils(_EV).exe`.
- The driver for DSX Core installations is called `DSX-TopologyUtils(_EV).exe`.

Please pay attention to the following considerations:

- A new driver should not be installed before the new hardware is installed.
- The use of a different driver version than that which was shipped with the video board is not recommended.
- A driver version, which is not recommended, causes the system to be unresponsive in most cases.
- Use the supplied driver installer application, and do not rely on drivers automatically installed by the operating system.
- Please refer to the Drivers and Configuration History section for information on which driver version is recommended for the Matrox video card and Viz Engine version in use. As there are many driver versions available, it is important to compare the versions reported by the Matrox X.info utility to check that the driver and firmware versions match. A warning is displayed if the versions do not match.

This section contains information on the following topics:

- [To Install the Matrox Driver](#)
- [To Remove the Matrox Driver](#)
- [To Upgrade the Matrox Driver](#)
- [To Check the Installation](#)
- [To Check the Installation with Windows Device Manager](#)

To Install the Matrox Driver

1. Locate the latest Matrox driver (DSX.utils): <ftp://ftp.vizrt.com/products/Vizrt%20Drivers/Matrox/Xmio/ <driver>/>.
2. Download and save the installation file to the local hard drive.
3. Open the downloaded *DSX.utils.exe* file. This file automatically extracts the installation files and launches the installation wizard.

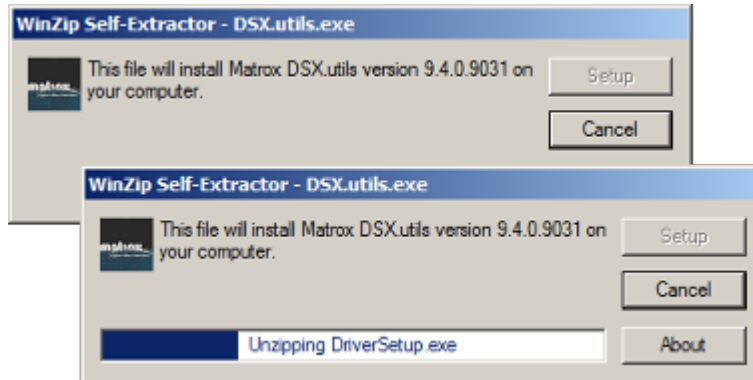

4. Follow the on screen instructions.

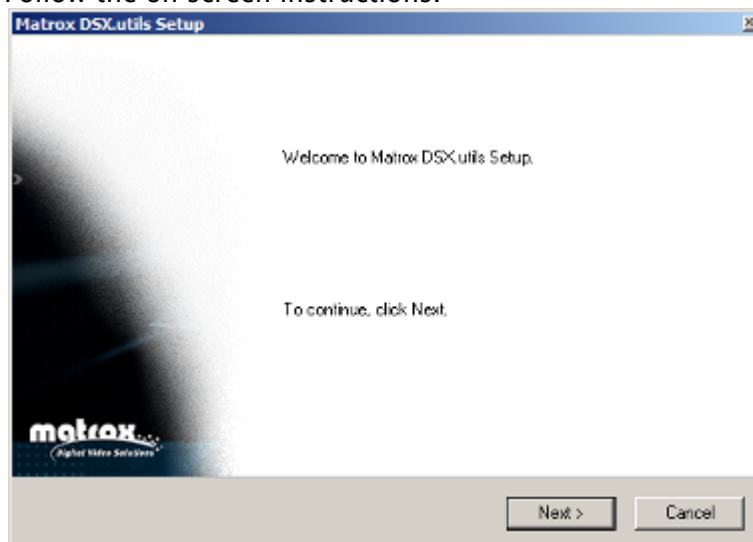

5. In case the Windows Security window pops up, tick the **Always trust software from Matrox Electronic Systems** check-box. This allows for a faster installation procedure in any subsequent driver installations. If left un-checked, each required driver needs explicit permission to be installed.

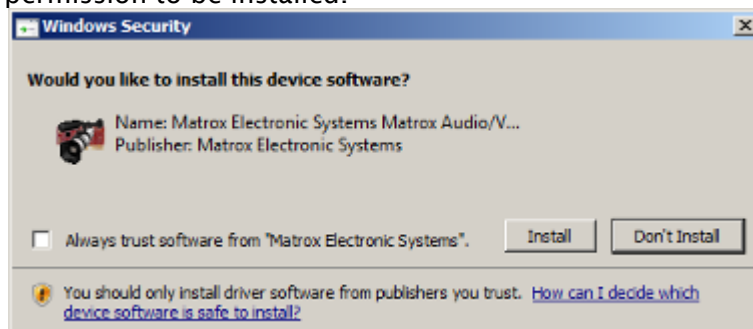

6. Click **Install** to start the installation. The installation can take several minutes.

- When completed, a pop-up window appears to confirm the successful installation. Click **OK**.

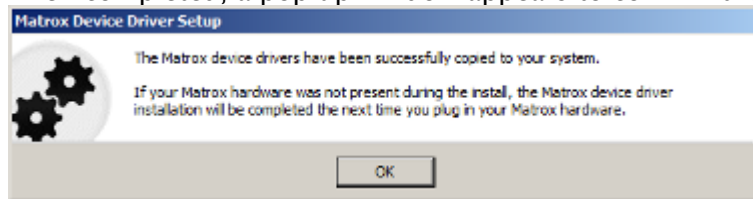

- After the driver has been installed, an icon (1) appears in the system tray.



Note: The firmware upgrade now starts. This can take a few minutes to complete.

To Remove the Matrox Driver

- Go to **Start > Control Panel > Programs and Features**.
- Locate the *Matrox DSX.utils <version>*.
- Click the **Uninstall** button, or right click the entry and select **Uninstall** from the context menu.
- Follow the on screen instructions.

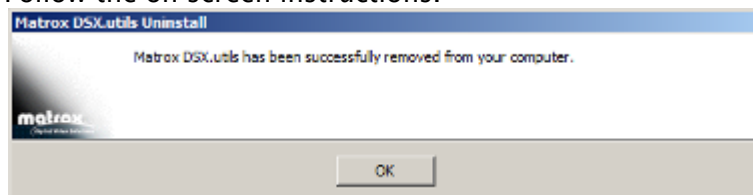

- Reboot the system.

Tip: In some cases, the Matrox driver removal process automatically reboots the system.

To Upgrade the Matrox Driver

- Remove the old *DSX.utils* (see To Remove the Matrox Driver).
- Reboot system.
- Install the new *DSX.utils* (see To Install the Matrox Driver).

To Check the Installation

- Click the Matrox system tray icon.
- Select **Open X.info**.

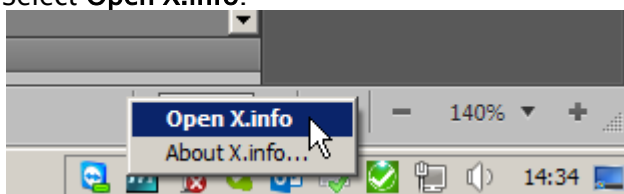

3. In the Display Information About drop-down, select **System**.

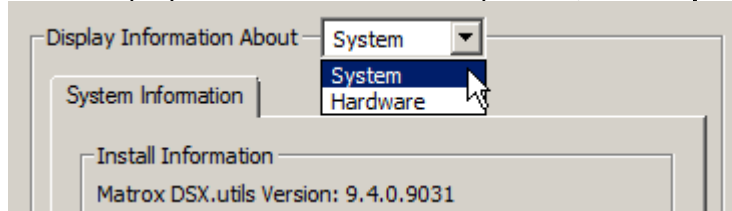

4. Check that the correct driver version was installed.

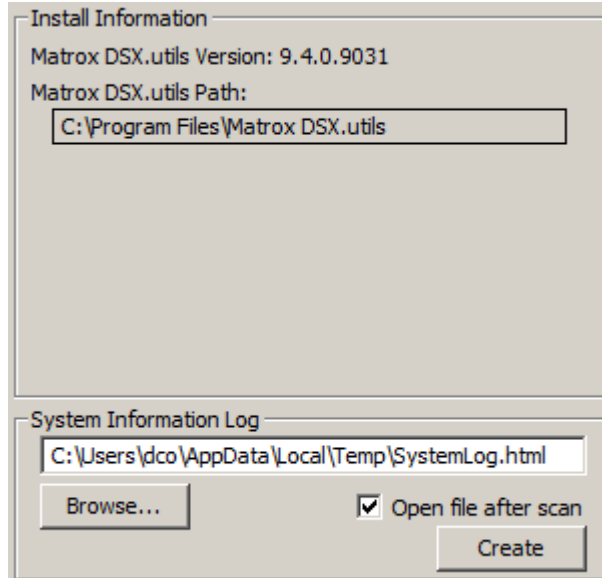

5. In the **Display Information About** drop-down, select **Hardware** and click on the installed card tab, for example **LE3/22C**.

Note: The information shown in the panel can look different depending on the installed Matrox card.

The screenshot shows a web interface for the LE3 /22C Card. It has two tabs: 'LE3 /22C Card' (selected) and 'Display Card'. Under the 'LE3 /22C Card' tab, there is a 'Hardware Information' section with an 'Upgrade Model' button. The hardware information includes: Serial Number: A497596, Board ID: 0, Production Date: 2013-06-19, Installed Options: Compositor, Scaler, Firmware Revision: Primary Dev. 0.6.0, Secondary Dev. 0.17.3, EEPROM Revision: 5.0, Memory Size: 512 MB, PCI Bus Info: PCI Express X8, and Hardware Model: DSXLE3/550. Below this is a 'Temperature (°C)' section with three rows of data: Backplane (Current: 48.0, Max: 65.0), 1st FPGA (Current: 71.2, Max: 85.0), and 2nd FPGA (Current: 54.6, Max: 85.0). Each row has a green progress bar indicating the current temperature relative to the maximum.

6. Check the these details:

- Under Hardware Information, check the Installed Options for Compositor, to confirm that the board is taking advantage of the on-board compositor. Some boards do not have an on-board compositor. The Matrox X.mio2 Plus does have an on-board compositor, even though this is not listed.
- See PCI Bus Info and check that the board was put into a PCIe slot operating at the right frequency.
- See Hardware Model, for example, X.mio2 Plus 8500, to check for Mixed Mode Video Support.

To Check the Installation with Windows Device Manager

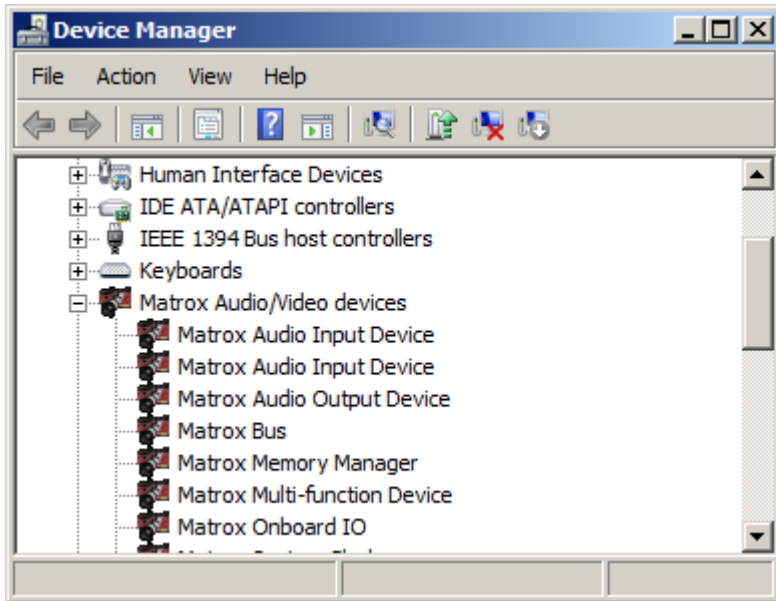

1. Start the **Device Manager**, by either:
 - Click **Start**, then **Run**, and type `devmgmt.msc`, or
 - Right-click **My Computer**, select **Manage** and then **Device Manager**, or
 - Right-click **My Computer**, select **Properties** and click the **Hardware** tab, then click **Device Manager**, or
 - Run the command `start devmgmt.msc` from the **Command Prompt**
2. Expand the **Matrox Audio/Video devices** node to see the devices that are installed.

Troubleshooting Matrox Video Hardware

It might be necessary to reset the X.mio2 Plus board. This needs to be done for example when Viz Engine reports:

- "0xefac9019: Generic driver error: The requested operation was unsuccessful" at startup.
- "0xeddd8008: Topology driver error: Watchdog specified already in use by another application." at startup.
- "VideoClipInOut_Xmio2Plus::SequenceVideoOut SequenceVideoOut no output node." during operation.

For this a reset mechanism has been implemented for the Viz Engine. To activate this mechanism, do this procedure:

1. Stop all Viz Engines (in dual channel setups both Viz Engines must be stopped).
2. Open the Viz Configuration file.
3. Set `Matrox0.ResetTopology = 1`.
4. Start up the respective Viz Engines.

Note: The `Matrox0.ResetTopology` setting is automatically set back to 0 after the reset has been performed.

The reset feature also clears the on-board memory of the X.mio2 Plus board. This operation removes all Matrox X.RIOs and their topologies from the on-board memory. After the reset, everything is restored automatically according to the configuration settings. This also applies to both Viz Engines in a Dual Channel setup.

Replacing a Video Board

This procedure describes how to safely replace a video board on a system with an existing video board, or a system that previously has had a video board installed.

1. Remove the video board drivers.
2. Shut down the machine.
3. If present, remove the currently installed video board.
4. Install the replacement video board.
5. Install the video board drivers.

IMPORTANT! When changing a Matrox video board the `Matrox.Devices` setting, set in the Viz Config file's `SECTION MATROX_CONFIG`, is not updated. The Matrox support is not correct and the new board does not work. In this case, the setting must be removed and Viz Engine restarted such that Viz Engine can insert the new serial number.

5.4.2 BlueFish444

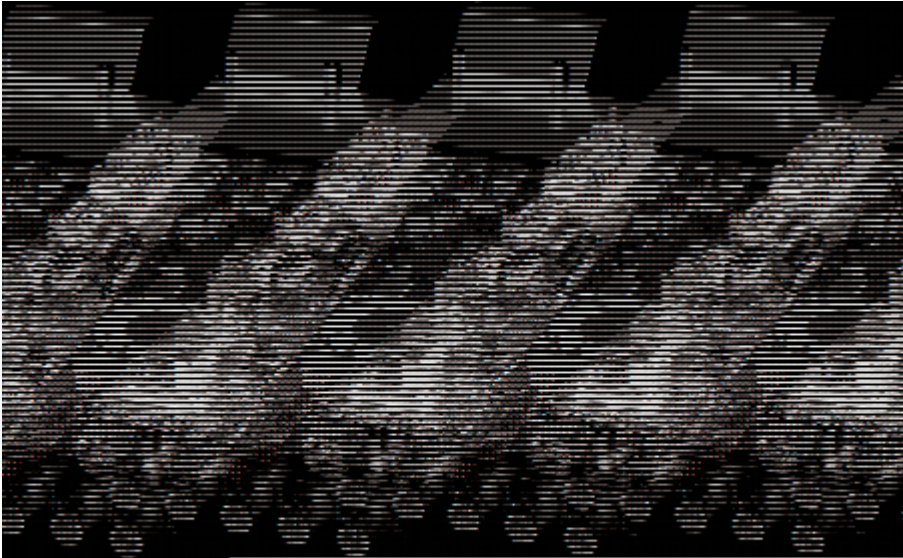

Viz Engine supports the following BlueFish444 video boards:

- Epoch | 4K Supernova
- Epoch | 4K Supernova S+
- Epoch | Supernova CG
- Epoch | Neutron (introduced in Viz version 3.7.0)

Since Viz version 3.5 and later, these boards replace the SD Lite Pro Express, which is considered a legacy board but works for Viz 3.5 installations.

Some of the main supported features are:

- Embedded audio input and output. Note that all 16 channels are used; however, there are currently no configuration options available for these channels (e.g. routing of channels, enable/disable channels etc).
- ANC data (both HANC and VANC), such as VITC and RP188 time codes, is supported. Data from the input is laid over the output. Ingestion of time codes from time code reader boards is supported as well.
- Two video inputs and outputs and one Genlock.
- Automatic bypass (aka [Special Configuration Options for Bluefish444](#)) of video if the Viz Engine crashes.
- Constant delay of four frames from input to output.

Note: Other BlueFish444 and Digital Voodoo boards are no longer supported (see the [Legacy Information](#) section).

Epoch 4K Supernova, Epoch 4K Supernova S+ and Epoch Supernova CG

The BlueFish444 Epoch | 4K Supernova, Epoch | 4K Supernova S+ and Epoch | Supernova CG boards are intended for character generators such as Viz Trio, but can also be used as an alternative where only two inputs and outputs are required.

This section contains information on the following:

- [Epoch | 4K Supernova](#)
 - [Epoch | 4K Supernova Connectors](#)
- [Epoch | 4K Supernova S+](#)
 - [Epoch | 4K Supernova S+ Connectors](#)
- [Epoch | Supernova CG](#)
 - [Epoch | Supernova CG Connectors](#)

Epoch | 4K Supernova

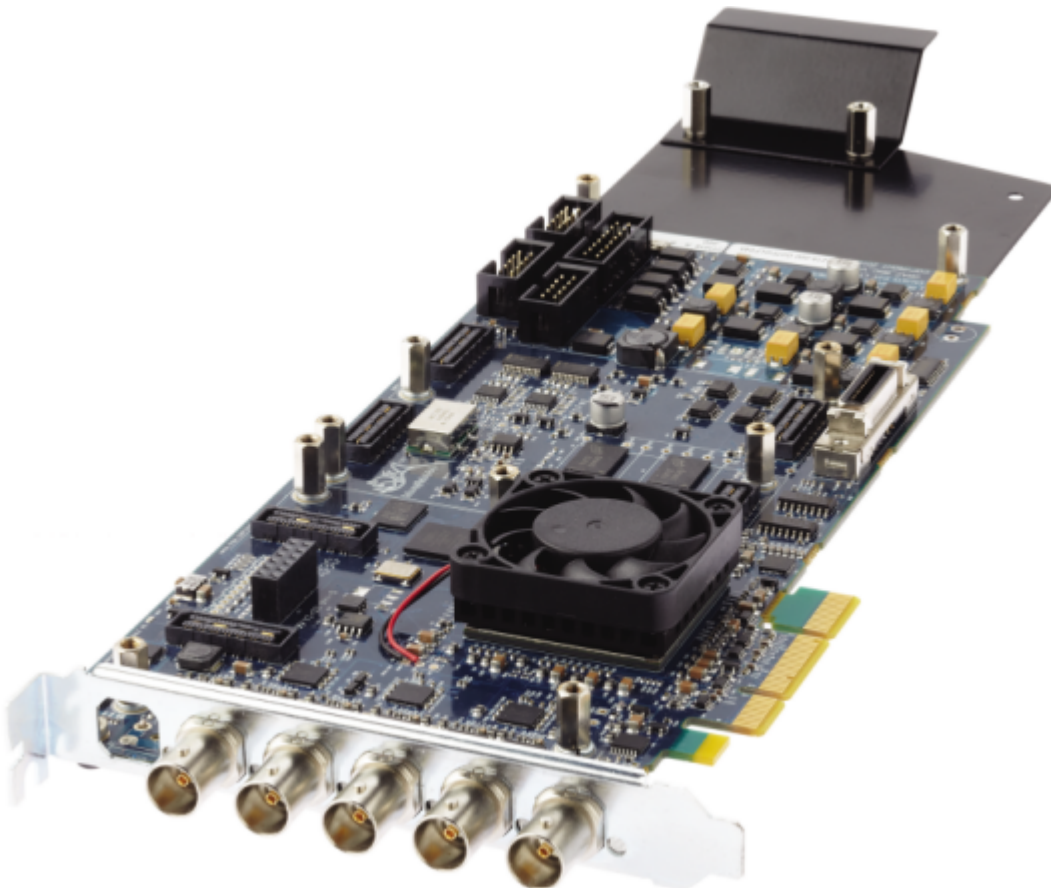

The Epoch | Supernova is a full-length PCIe card with five bi-directional multi-format I/O BNC connectors that support a number of configurations with up to two dual link channels or four

single link channels. For use with Viz Engine, the card needs to be configured with two inputs and two outputs.

Epoch | 4K Supernova Connectors

With five BNC connectors, each of the first four do SD, HD, 3G, ASI, AES and LTC as either input or output. The fifth is the designated GenLock or SD, HD, 3G, ASI or AES (no LTC).

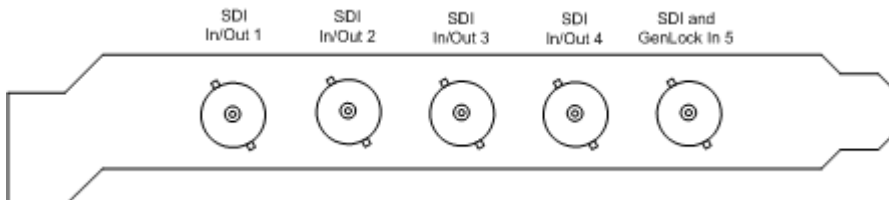

On the Epoch | 4K Supernova, the default connector configuration for the five connectors are:

- Output one
- Input one
- Output two
- Input two
- Reference In (Genlock)

If the `dual_link_input` flag is set to 1 in the Viz Configuration file, the two inputs are treated as one channel with fill on the first and key on the second. Please refer to the [Special Configuration Options for Bluefish444](#) section for more information.

Epoch | 4K Supernova S+

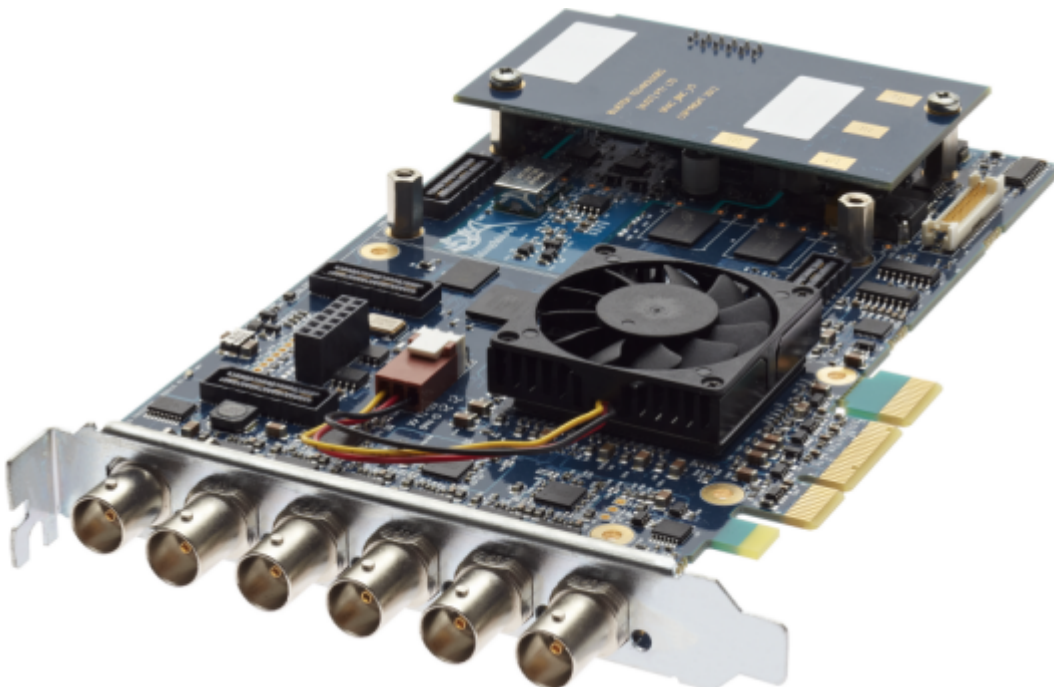

The Epoch | Supernova S+ is a 2/3-length PCIe card with bi-directional multi-format I/O BNC connectors that support a number of configurations, up to two dual link channels or four single link channels. For use with Viz Engine, the card needs to be configured with two inputs and two

outputs. With six BNC connectors, each of the first four do SD, HD, 3G, ASI, AES and LTC as either input or output. The fifth is the designated GenLock or SD, HD, 3G, ASI or AES (no LTC).

Epoch | 4K Supernova S+ Connectors

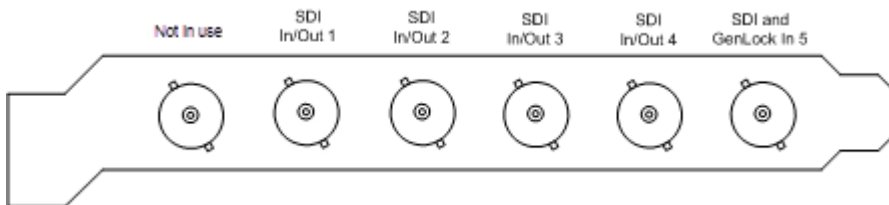

On the Epoch | 4K Supernova S+, the default connector configuration for the six connectors are:

- *Not in use*
- Output one
- Input one
- Output two
- Input two
- Reference In (Genlock)

⚠ Note: Viz Engine does not utilize the top BNC connector on the Epoch | 4K Supernova S+ video card, recognized as not being flush with the other five.

If the `dual_link_input` flag is set to 1 in the Viz Configuration file, the two inputs are treated as one channel with fill on the first and key on the second. Please refer to the [Special Configuration Options for Bluefish444](#) section for more information.

Epoch | Supernova CG



The Epoch | Supernova CG is a 2/3-length PCIe card with bi-directional multi-format I/O BNC connectors that support a number of configurations, up to two dual link channels or four single link channels. For use with Viz Engine, the card needs to be configured with two inputs and two outputs. With five BNC connectors, each of the first four do SD, HD, 1.5G, ASI, AES and LTC as either input or output. The fifth is the designated GenLock or SD, HD, 1.5G, ASI or AES (no LTC).

Epoch | Supernova CG Connectors

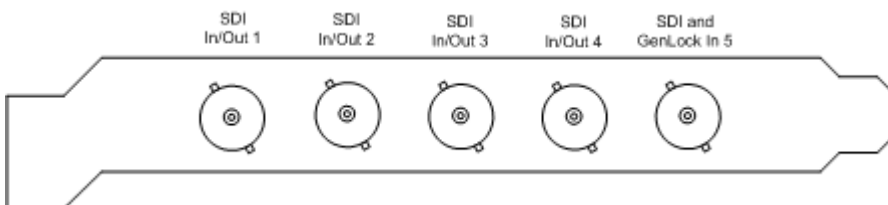

On the Epoch | Supernova CG, the default connector configuration for the five connectors are:

- Output one
- Input one
- Output two
- Input two
- Reference In (Genlock)

If the `dual_link_input` flag is set to 1 in the Viz Configuration file, the two inputs are treated as one channel with fill on the first and key on the second. Please refer to the [Special Configuration Options for Bluefish444](#) section for more information.

See Also

- [Configuration History for BlueFish444](#)
- [Special Configuration Options for Bluefish444](#)
- [Video Board](#)

Epoch Neutron



The Epoch | Neutron is a full-length PCIe card with three bi-directional multi-format I/O BNC connectors that support dual link configurations. For use with Viz Engine, the card needs to be configured with one input and one output. Of the three BNC connectors, the first two do SD, HD, 1.5G, ASI, AES and LTC as either input or output. The third is used for GenLock.

✓ **Tip:** The Epoch | Neutron is capable of downstream keying. To achieve this, add a Media Asset as DVE when creating a scene in Viz Artist.

Epoch | Neutron Connectors

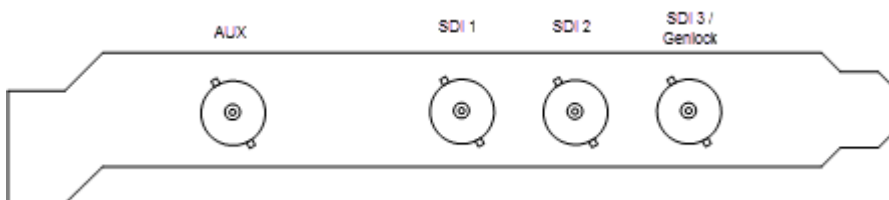

On the Epoch | Neutron, the default connector configuration for the four connectors are:

- AUX connector (Not Used)
- (empty space)
- Output one (fill)
- Input one
- Reference IN

If the `dual_link_output` flag is set to 1 in the Viz configuration file, the key output is enabled on the bottom BNC connector. The Genlock signal gets moved to the AUX connector at the top.

- Reference In
- (empty space)
- Output one (fill)
- Input one
- Output two (key)

Please refer to the [Special Configuration Options](#) section for more information.

See Also

- [Configuration History for BlueFish444](#)
- [Special Configuration Options](#)
- [Video Board](#)
- [Media Assets as DVE in the Viz Artist Guide](#)

Configuration History for BlueFish444

Use the driver version available on the [Vizrt FTP server](#) to make sure of correct functionality and ringbuffer support.

The following driver and firmware versions are supported:

Viz Release	Driver Version	Supernova Firmware	Neutron Firmware
3.9.0 - 3.13.x	5.11.0.45	2i2o 145	1i2o 027
3.8.1 - 3.8.2	5.11.0.39	2i2o 134	1i2o 025
3.8.0	5.11.0.25	2i2o 127	1i1o 067
3.7.1	5.11.0.14	2i2o 108	1i1o 054
3.7.0	5.11.0.7	2i2o 096 Rev. 2	1i1o 016 Rev. 2
3.6.4	5.11.0.3	2i2o 096	N/A
3.6.3	5.10.2.18	2i2o 094	N/A
3.6.1 - 3.6.2	5.10.2.4	2i2o 053	N/A
3.5.1 - 3.5.4	5.10.1.11	2i2o 031	N/A
3.5.0	5.9.0.78	442	N/A

Special Configuration Options for Bluefish444

This section describes the procedures to configure the following options when running a Bluefish444 setup:

- [To Enable Dual Link Input for Epoch | 4K Supernova and Epoch | 4K Supernova S+ Boards](#)
- [To Enable Dual Link Output for Epoch | Neutron](#)
- [To Enable Automatic Bypass for BlueFish444 Epoch Boards](#)

To Enable Dual Link Input for Epoch | 4K Supernova and Epoch | 4K Supernova S+ Boards

1. Stop Viz Engine.
2. Open the **Viz Configuration file** (for example: *VIZ-<hostname>-0-0.cfg*).

 **Note:** The default location for this file is *%ProgramData%\Vizrt\Viz3*.

3. Locate SECTION VIDEO.
4. Enable the **Dual Link Input** setting by changing the default value 0 to 1: `dual_link_input = 1`.
5. Save the file.
6. Start Viz Engine.

To Enable Dual Link Output for Epoch | Neutron

1. Stop Viz Engine.
2. Open the **Viz Configuration file** (for example: *VIZ-<hostname>-0-0.cfg*).

 **Note:** The default location for this file is *%ProgramData%\Vizrt\Viz3*.

3. Locate SECTION VIDEO.
4. Enable the **Dual Link Output** setting by changing the default value 0 to 1: `dual_link_output = 1`.
5. **Save** the file.
6. Start Viz Engine.

To Enable Automatic Bypass for BlueFish444 Epoch Boards

Viz Engine supports automatic mechanical bypass (copper-to-copper) of video for BlueFish444 Epoch boards. To use this feature enable the feature.

1. Stop Viz Engine.
2. Open the **Viz Configuration file** (for example: *VIZ-<hostname>-0-0.cfg*)

 **Note:** The default location for this file is *%ProgramData%\Vizrt\Viz3*.

3. Locate SECTION VIDEO.
4. Enable the Watchdog setting by changing the default value 0 to 1: `video_use_watchdog = 1`.
5. **Save** the file.
6. Start Viz Engine.

See Also

- [Configuration History for BlueFish444](#)
- [Video Board](#)

5.4.3 AJA Hardware

VizEngine with AJA Hardware supports up to two 3G-SDI inputs and fill/key output.

This section contains information on the following topics:

- [Overview and Connectors](#)
- [Configuration](#)
- [Audio Configuration](#)
- [Video Configuration](#)
- [Configuration Utilities](#)
- [Firmware Upgrade](#)

Overview and Connectors

AJA boards support current SD and HD SDI workflows with frame rates up to 50p/59.94p. Audio is supported as embedded signal in the SDI stream.

Configuration

 **IMPORTANT!** For 1080p only 3G Level A is supported.

Audio Configuration

Embedded audio is supported, always with 16 channels in and out. However, mixer settings are active, and respected. Example: if the user requests only two-channel output, the remaining 14 channels are silent.

Video Configuration

The default configuration is:

Live Input 1	SDI 1
Live Input 2	SDI 2
Fill Output	SDI 3
Key Output	SDI 4
Genlock	[REF IN]

If Live Input 2 is inactive in the configuration, SDI 2 is enabled for preview output.

Configuration Utilities

Vizrt includes two configuration utilities from AJA:

- **cables.exe** This utility shows the current topology running: inputs, outputs, color space conversion, fill and key paths. Firmware and driver version information is also accessible. Screen-shots of *cables.exe* usage showing two typical topologies (two video inputs and one video and one preview) are shown below:

i Example: Topology using two video inputs:

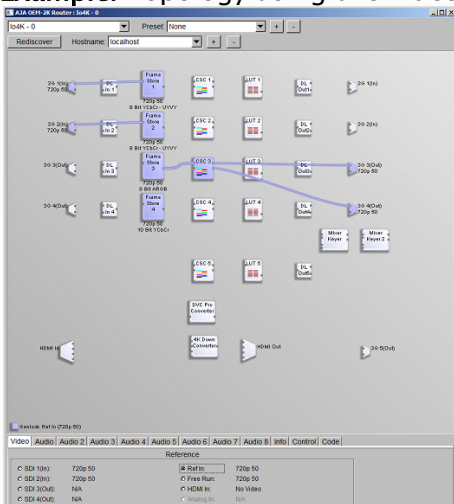

i Example: One video input, one preview:

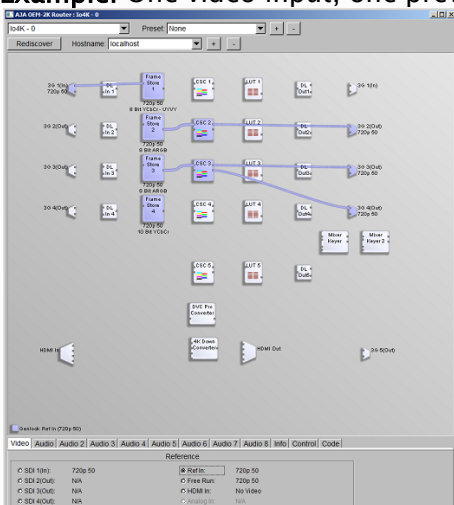

- **watcher.exe** This utility shows register settings. You may also write out a status log file. The auto-circulate engine is also observable. This utility is mostly of value for support specialists.

Firmware Upgrade

Only do an upgrade of Io4K firmware if instructed to do so by Vizrt or AJA support. All files for firmware upgrade are provided in a separate directory, typically supplied as a zip-archive. To install the firmware:

1. Open a command window.
2. `cd` to the directory where the firmware upgrade files are located. Make sure no other programs are running that could interfere with the firmware upgrade.
3. Install the firmware, in this example named `IO_XT_4K_13.bit`, using the `ntv2firmwareinstaller` utility (e.g. `ntv2firmwareinstaller -f IO_XT_4K_13.bit`).
4. The window then pauses for a few minutes. When the firmware upgrade is complete, the command line program asks for a return key press to exit. Please be patient, the firmware upgrade can take three to six minutes or more, depending on hardware.
5. Power-cycle the Io4K and reboot the computer to make sure the upgraded firmware configuration is active.

See Also

- Manufacturer's documentation (external link at www.aja.com): [AJA Io 4K](#)

AJA Kona 3G

Overview and Connectors

Only the connectors SDI 1 - 4 and the Ref In connector are implemented for use in Viz Engine. For information on the connector mapping, please see [AJA Hardware](#).

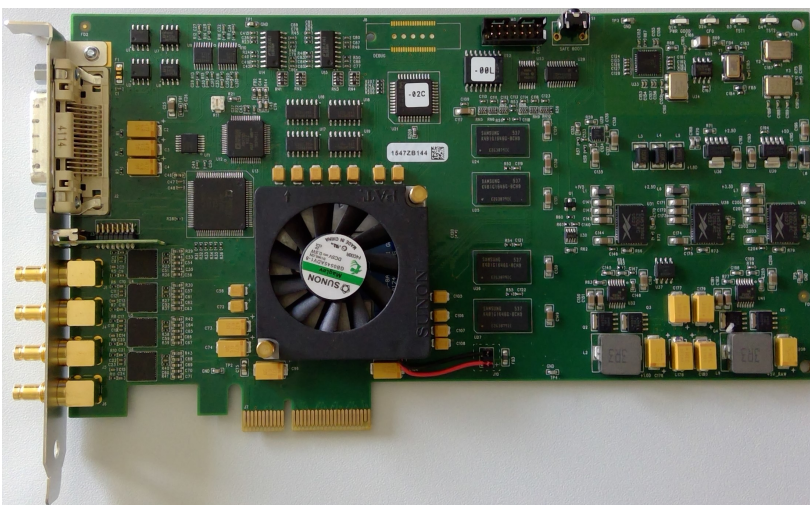

AJA Kona 4

Overview and Connectors

Only the connectors SDI 1 - 4 and the Ref In connector are implemented for use in Viz Engine. For information on the connector mapping please see [AJA Hardware](#).

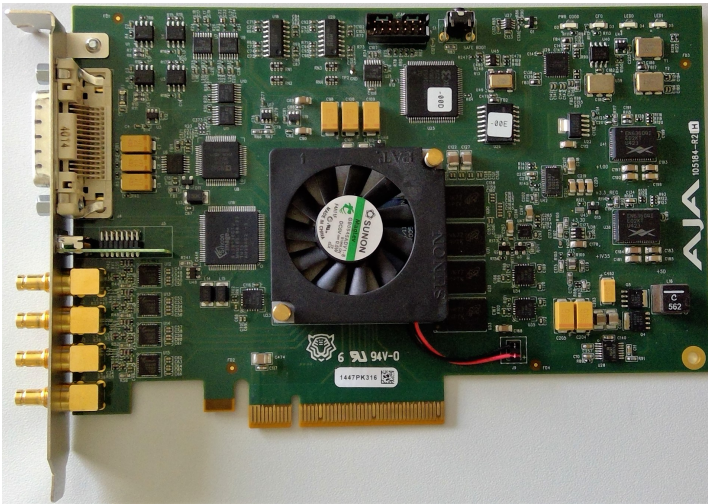

AJA Io 4K

Overview and Connectors

The AJA Io 4K is typically used in combination with a suitable mobile workstation connected via Thunderbolt 2 interface.

Only the connectors SDI 1 - 4 and the Ref In connector are implemented for use in Viz Engine. For information on the connector mapping please see [AJA Hardware](#).



⚠ Note: Connecting the device to a workstation with a Thunderbolt 3 interface using a Thunderbolt 3 to Thunderbolt 2 converter reduces the performance of the device.

AJA Io 4K Plus

Overview and Connectors

The AJA Io 4K Plus is the next generation of this series. The only differences related to the implementation with VizEngine and the hardware are the usage of Thunderbolt 3 as connection interface, and the fact that the Ref In/LTC In and LTC Out connectors changed places.

As with its predecessor, only the connectors SDI 1 - 4 and the Ref In connector are implemented for use in Viz Engine. For information on the connector mapping, please see [AJA Hardware](#).



AJA Kona IP

Overview

The AJA Kona IP supports a one Stream Input and one IP Stream Output. For information on the connector mapping please see [AJA Hardware](#).

Note: Only J2K format is supported!

5.5 Legacy Information

This section contains information on the following topics:

- [Deprecated systems](#)
- [Deprecated Video Boards](#)
- [Legacy Graphic Boards](#)

5.5.1 Deprecated systems

The following servers are deprecated. The information in this section is for historical reference only and is not updated for new hardware.

- [HP ML350p Gen8](#)
- [HP Z420](#)
- [HP Z800](#)
- [HP Z820](#)

- [HP DL370](#)
- [HP xw8200](#)
- [HP xw8400](#)
- [HP xw8600](#)





HP ML350p Gen8

This section describes how to setup a HP ML350p Gen8 machine with the different cards provided by Vizrt.



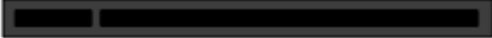

To Setup an HP ML350p Gen8 with a DVS board

PCI-X, PCI slots, HP ML350p Gen8

Slot Processor 1

1		PCIe3 x16 (8, 4, 2, 1)
2		PCIe3 x8 (4, 1)
3		PCIe3 x16 (16, 8, 4, 1)
4		PCIe3 x8 (4, 1)

Processor 2

5		PCIe2 x8 (4, 1)
6		PCIe3 x16 (16, 8, 4, 1)
7		PCIe3 x8 (4, 1)
8		PCIe3 x16 (16, 8, 4, 1)
9		PCIe3 x8 (4, 1)

⚠ IMPORTANT! Before touching any components make sure you use an anti-static wrist strap to prevent electrostatic discharge.

1. Disconnect the power and all other peripherals.
2. Install the video board in slot 1.
3. Install the graphic card in slot 6.

⚠ Note: Make sure that the cable connections are correctly mounted and that they stay clear of any supplemental aerators or the aerator of the graphics device.



4. Tidy up all cables and close the computer case.

Note: Placement of cards are the same for both DVS Atomix HDMI (see [DVS Centaurus II](#)).



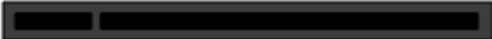

To Setup an HP ML350p Gen8 with a Matrox board

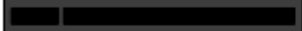
PCI-X, PCI slots, HP ML350p Gen8

Slot Processor 1

1		PCIe3 x16 (8, 4, 2, 1)
2		PCIe3 x8 (4, 1)
3		PCIe3 x16 (16, 8, 4, 1)
4		PCIe3 x8 (4, 1)

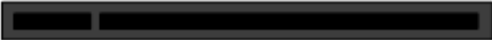
Processor 2

5		PCIe2 x8 (4, 1)
6		PCIe3 x16 (16, 8, 4, 1)
7		PCIe3 x8 (4, 1)
8		PCIe3 x16 (16, 8, 4, 1)
9		PCIe3 x8 (4, 1)

IMPORTANT! Before touching any components make sure you use an anti-static wrist strap to prevent electrostatic discharge.

1. Disconnect the power and all other peripherals.
2. Insert the video board in slot 1.
3. Insert graphic card 1 in slot 6.
4. Insert graphic card 2 in slot 8.
5. Insert the Matrox audio board in slot 3.
6. Insert the radial-aerator in slot 2.

IMPORTANT! A radial-aerator is mandatory as the video board reaches high temperatures during operation.

7. Insert the slot panel (x2) for the X.mio2/44 board in slot 4. Connect it to the X.mio2 board.
8. Tidy up all cables and close the computer's casing.
9. Start the machine.
Once the machine is powered up, check that the Matrox X.mio board has been correctly installed. Check that the blue OB-light on the (top) backside of the slot panel is set to ON. If the LED is ON the board is correctly supplied with power.

HP Z420

This section describes how to setup a HP Z420 machine with the different cards provided by Vizrt.

To Setup an HP Z420 with a BlueFish444 Epoch board

PCI-X, PCI and AGP slots, HP Z420

Audio card	19		PCIe2 x4(1)
Graphics card	20		PCIe3 x16
	21		PCIe2 x8(4)
Video card	22		PCIe3 x8
Radial aerator	23		PCIe3 x16
	24		PCI 32bit/33MHz

IMPORTANT! Before touching any components make sure you use an anti-static wrist strap to prevent electrostatic discharge.

1. Disconnect the power and all other peripherals.
2. Insert the graphics card in slot 20.
3. Insert the BlueFish444 video board in slot 22.

Note: If you are using the BNC adapter with the Epoch|2K Horizon board it can be placed directly adjacent the video board on either side.

4. Tidy up all cables and close the computer's casing.

To Setup an HP Z420 with a DVS board

PCI-X, PCI and AGP slots, HP Z420

Audio card	19		PCIe2 x4(1)
Graphics card	20		PCIe3 x16
	21		PCIe2 x8(4)
Video card	22		PCIe3 x8
Radial aerator	23		PCIe3 x16
	24		PCI 32bit/33MHz

⚠ IMPORTANT! Before touching any components make sure you use an anti-static wrist strap to prevent electrostatic discharge.

1. Disconnect the power and all other peripherals.
2. Install the video board in slot 22.
3. Install the graphics card in slot 20.
4. Install the video board two extension boards:
 - SDI/RS-422 panel in slot 19
 - BNC panel in slot 23



⚠ Note: Make sure that the cable connections are correctly mounted and that they stay clear of any supplemental aerators or the aerator of the graphics device.

5. Tidy up all cables and close the computer's casing.

⚠ Note: Placement of cards are the same for both DVS Atomix HDMI (see [DVS Centaurus II](#)).

To Setup an HP Z420 with a Matrox board

PCI and PCIe slots, HP Z420

Audio card	19		PCIe2 x4(1)
Graphics card	20		PCIe3 x16
	21		PCIe2 x8(4)
Video card	22		PCIe3 x8
Radial aerator	23		PCIe3 x16
	24		PCI 32bit/33MHz

⚠ IMPORTANT! Before touching any components make sure you use an anti-static wrist strap to prevent electrostatic discharge.

1. Disconnect the power and all other peripherals.
2. Insert the graphics card in slot 20.
3. Insert the Matrox video board in slot 22.
4. Insert the radial-aerator in slot 23.

⚠ IMPORTANT! A radial-aerator is mandatory as the video board reaches high temperatures during operation.





5. *Optional:* Insert the [Matrox](#) video board in slot 19.

6. *Optional:* Insert the extra slot panel for the X.mio2/44 board in any of the vacant slots, and connect it to the X.mio2 board.
7. Tidy up all cables and close the computer's casing.
8. Start the machine. The Matrox X.mio2+ gets very hot in the HP Z420. Make sure that the HP Z420 Fan and Front Card Guide Kit is installed, and set the fan speed to the highest value in BIOS (Power -> Thermal).

Once the machine is powered up, check that the Matrox X.mio board has been correctly installed. Check that the blue OB-light on the (top) backside of the slot panel is set to ON. If the LED is ON the board is correctly supplied with power.

To Setup an HP Z420 with a capture card

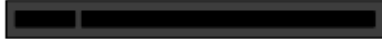
PCI and PCIe slots, HP Z420

Audio card	19		PCIe2 x4(1)
Graphics card	20		PCIe3 x16
	21		PCIe2 x8(4)
Video card	22		PCIe3 x8
Radial aerator	23		PCIe3 x16
	24		PCI 32bit/33MHz

IMPORTANT! Before touching any components make sure you use an anti-static wrist strap to prevent electrostatic discharge.

1. Disconnect the power and all other peripherals.
2. Insert the graphics card in slot 20.
3. Insert the NVIDIA capture card in slot 22.
4. Tidy up all cables and close the computer's casing.

HP Z800

This section describes how to setup a HP Z800 machine with the different cards provided by Vizrt.

To Setup an HP Z800 with a BlueFish444 Epoch board

PCI-X, PCI and AGP slots, HP Z800



⚠ IMPORTANT! Before touching any components make sure you use an anti-static wrist strap to prevent electrostatic discharge.

1. Disconnect the power and all other peripherals.
2. Insert the graphics card in the PCIe slot number 2 from the top.
3. Insert the BlueFish444 video board in the PCIe slot number 4 from the top.

⚠ Note: If you are using the BNC adaptor with the Epoch|2K Horizon board it can be placed directly adjacent the video board on either side.

To Setup an HP Z800 with a DVS board

PCI-X, PCI and AGP slots, HP Z800



IMPORTANT! Before touching any components make sure you use an anti-static wrist strap to prevent electrostatic discharge.

1. Disconnect the power and all other peripherals.
2. Install the video board in slot number 5 from the top.
3. Install the graphics card in slot number 2 from the top.
4. Install the separate SDI/RS-422 panel in slot number 1 from the top. Make sure that the cable connections are properly mounted and that it stays clear of any supplemental aerators or the aerator of the graphics device.
5. Tidy up all cables and close the computer's casing.

Note: Placement of cards are the same for [DVS Centaurus II](#).

To Setup an HP Z800 with a Matrox board

PCI and PCIe slots, HP Z800



IMPORTANT! Before touching any components make sure you use an anti-static wrist strap to prevent electrostatic discharge.

1. Disconnect the power and all other peripherals.
2. Insert the graphics card in PCIe2 slot number 2 from the top.
3. Insert the Matrox video board into the PCIe2 slot number 5 from the top.
4. Insert the radial-aerator into the PCIe slot number 7 from the top.

IMPORTANT! The Matrox video boards can reach very high temperatures when in operation. If a Xmio.2 board is used, a radial-aerator must be installed. If a Xmio.2 Plus board is used a radial-aerator can not, physically, be installed. In this case the chassis fan speed (in BIOS) must be set to maximum to achieve sufficient cooling.

5. *Optional:* Insert the **Matrox** video board into the PCIe2 slot number 1 from the top.
6. *Optional:* Insert the extra slot panel for the X.mio2/44 board in any of the vacant slots, and connect it to the X.mio2 board.
7. Tidy up all cables and close the computer's casing.
Once the machine is powered up you may verify that the Matrox X.mio board has been correctly installed by looking for the blue OB-light on the (top) backside of the slot panel. A lit light indicates that the board is correctly supplied with power.

To Setup an HP Z800 with two graphics cards

PCI and PCIe slots, HP Z800



IMPORTANT! Before touching any components make sure you use an anti-static wrist strap to prevent electrostatic discharge.

1. Disconnect the power and all other peripherals.
2. Insert the weaker graphics card in PCIe2 slot number 2 from the top.
3. Insert the stronger graphics card in PCIe2 slot number 5 from the top.
4. Insert the Matrox video board in the PCIe2 slot number 4 from the top.
5. Insert the radial-aerator into the PCIe slot number 3 from the top. A radial-aerator is mandatory as the video board reaches high temperatures during operation.
6. *Optional:* Insert the [Matrox](#) video board into the PCIe2 slot number 1 from the top.
7. Tidy up all cables and close the computer's casing.
8. Connect the computer's monitor to the graphics card in slot 2 from the top.
9. Start the machine and in the BIOS (Advanced: Thermal - Full Fan speed) set all fans to run at full speed.
10. Boot and log on to the machine.
11. Install NVIDIA and Matrox drivers.
12. Open the NVIDIA Control Panel, and click on System Information in the bottom left corner and check that both graphics cards are installed and run at PCIe x16 speed.
13. Open Matrox X.info from the system tray and check that the video board runs at PCIe x8 speed.

Once the machine is powered up you may verify that the Matrox X.mio board has been correctly installed by looking for the blue OB-light on the (top) backside of the slot panel. A lit light indicates that the board is correctly supplied with power.

To Setup an HP Z800 with a capture card

PCI and PCIe slots, HP Z800

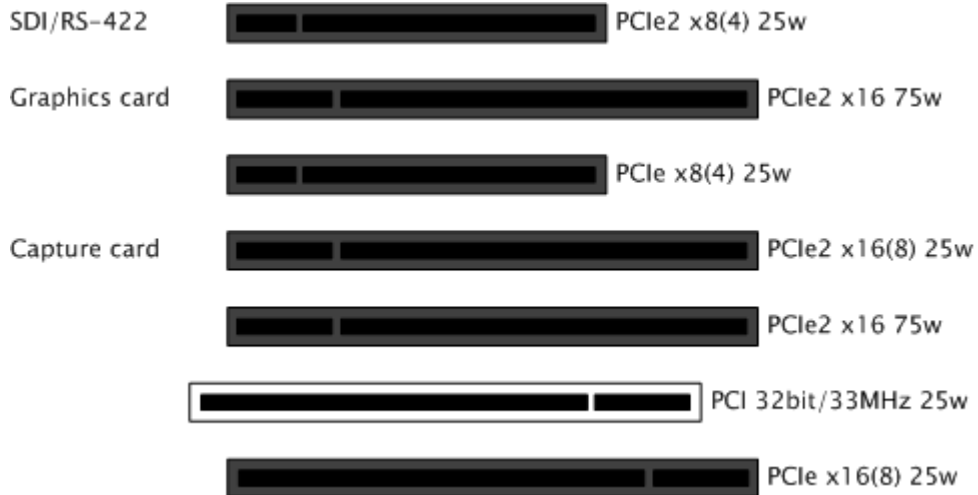

IMPORTANT! Before touching any components make sure you use an anti-static wrist strap to prevent electrostatic discharge.

1. Disconnect the power and all other peripherals.
2. Insert the graphics card in PCIe2 slot number 2 from the top.
3. Insert the NVIDIA capture card into the PCIe2 slot number 4 from the top.
4. Tidy up all cables and close the computer's casing.

HP Z820

This section describes how to setup a HP Z820 machine with the different cards provided by Vizrt.

To Setup an HP Z820 with a Matrox board

PCI and PCIe slots, HP Z820

Audio card	16		PCIe3 x8(4)
Graphics card	17		PCIe3 x16
	18		PCIe3 x16(8)
	19		PCIe3 x16
	20		PCIe2 x8(4)
Video card	21		PCIe3 x16
Radial aerator	22		PCI 32bit/33MHz

⚠ IMPORTANT! Before touching any components make sure you use an anti-static wrist strap to prevent electrostatic discharge.

1. Disconnect the power and all other peripherals.
2. Insert the graphics card in slot 17.
3. Insert the Matrox video board in slot 21.
4. Insert the radial-aerator in slot 22.

⚠ IMPORTANT! The Matrox video boards can reach very high temperatures when in operation. If a Xmio.2 board is used, a radial-aerator must be installed. If a Xmio.2 Plus board is used a radial-aerator can not, physically, be installed. In this case the chassis fan speed (in BIOS) must be set to maximum to achieve sufficient cooling.

5. *Optional:* Insert the in slot 16.
6. *Optional:* Insert the extra slot panel for the X.mio2/44 board in any of the vacant slots, and connect it to the X.mio2 board.
7. Tidy up all cables and close the computer's casing.
Once the machine is powered up, check that the Matrox X.mio board has been correctly installed. Check that the blue OB-light on the (top) backside of the slot panel is set to ON. If the LED is ON the board is correctly supplied with power.

To Setup an HP Z820 with two graphics cards

PCI and PCIe slots, HP Z820

Audio card	16		PCIe3 x8(4)
Graphics card	17		PCIe3 x16
	18		PCIe3 x16(8)
	19		PCIe3 x16
	20		PCIe2 x8(4)
Video card	21		PCIe3 x16
Radial aerator	22		PCI 32bit/33MHz

⚠ IMPORTANT! Before touching any components make sure you use an anti-static wrist strap to prevent electrostatic discharge.

1. Disconnect the power and all other peripherals.
2. Insert the weaker graphics card in slot 17.
3. Insert the stronger graphics card in slot 19.
4. Insert the Matrox video board in slot 21.
5. Insert the radial-aerator in slot 22.

⚠ IMPORTANT! A radial-aerator is mandatory as the video board reaches high temperatures during operation.

6. *Optional:* Insert the [Matrox](#) video board in slot 16.
7. Tidy up all cables and close the computer's casing.
8. Connect the computer's monitor to the graphics card in slot 17.
9. Start the machine.
10. In the BIOS (Advanced: Thermal - Full Fan speed) set all fans to run at full speed.
11. Boot and log on to the machine.
12. Install the NVIDIA and Matrox drivers.
13. Open the NVIDIA Control Panel, and click on System Information in the bottom left corner and check that both graphics cards are installed and run at PCIe x16 speed.
14. Open Matrox X.info from the system tray and check that the video board runs at PCIe x8 speed.
Once the machine is powered up, check that the Matrox X.mio board has been correctly installed. Check that the blue OB-light on the (top) backside of the slot panel is set to ON. If the LED is ON the board is correctly supplied with power.

HP DL370

This section describes how to setup a HP DL370 G6 machine with the different cards provided by Vizrt.

To Setup an HP DL370 G6 with one graphics card

PCI and PCIe slots, HP DL370 G6

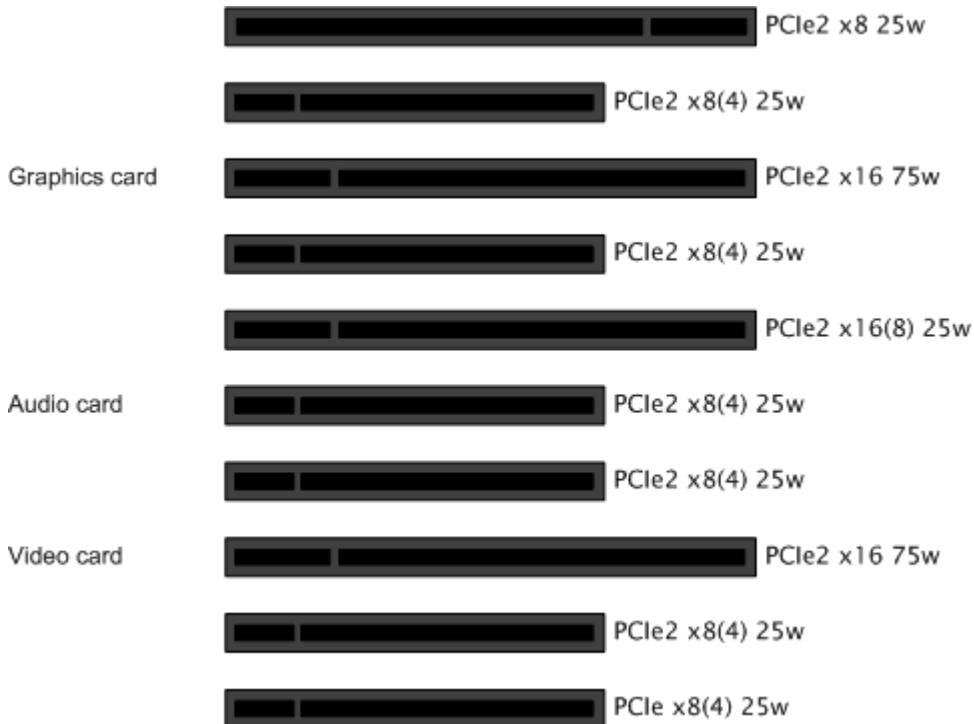

IMPORTANT! Before touching any components make sure you use an anti-static wrist strap to prevent electrostatic discharge.

1. Disconnect the power and all other peripherals.
2. Insert the graphics card in PCIe2 slot number 8 from the left.
3. Insert the video board (i.e. Matrox X.mio2) into the PCIe2 slot number 3 from the left.
4. If you have a Matrox board, insert the radial-aerator into the PCIe slot number 2 from the left. A radial-aerator is mandatory as the video board reaches high temperatures during operation.
5. *Optional:* Insert the [Matrox](#) into the PCIe2 slot number 5 from the left.
6. *Optional:* Insert the extra slot panel for the X.mio2/44 board in any of the vacant slots, and connect it to the X.mio2 board.
7. Tidy up all cables and close the computer's casing.

Note: Matrox DSX.LE cannot be mounted in the DL370 G6

Once the machine is powered up you may verify that the Matrox X.mio board has been correctly installed by looking for the blue OB-light on the (top) backside of the slot panel. A lit light indicates that the board is correctly supplied with power.

To Setup an HP DL370 G6 with two graphics cards

PCI and PCIe slots, HP DL370 G6

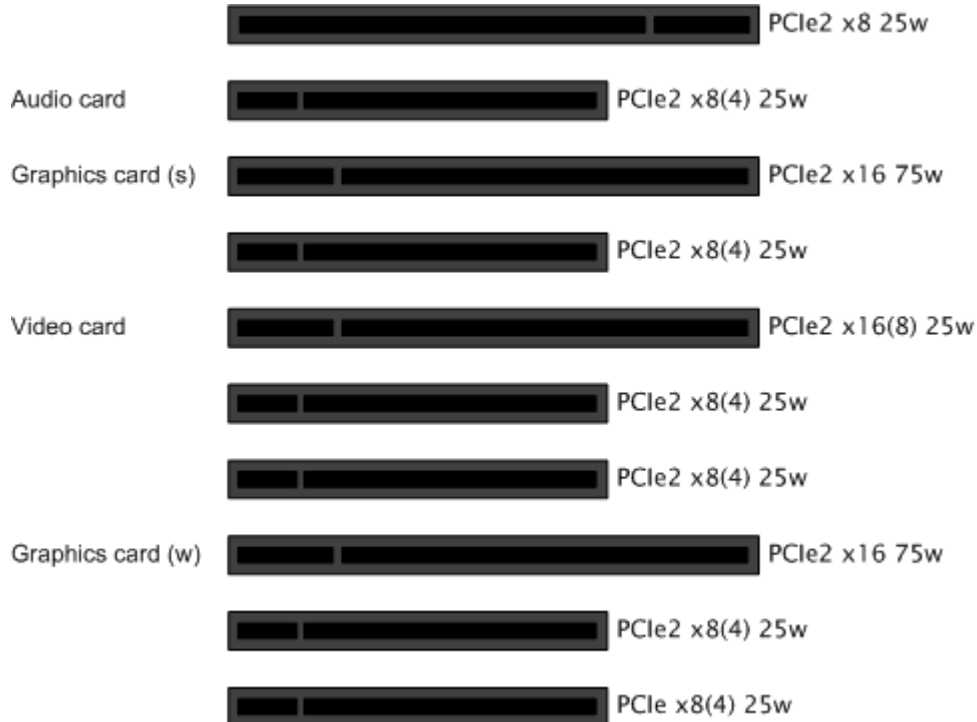

IMPORTANT! Before touching any components make sure you use an anti-static wrist strap to prevent electrostatic discharge.

1. Disconnect the power and all other peripherals.
2. Insert the weaker graphics card in PCIe2 slot number 3 from the left.
3. Insert the stronger graphics card in PCIe2 slot number 8 from the left.
4. Insert the video board (i.e. Matrox X.mio2) in the PCIe2 slot number 6 from the left.
5. If you have a Matrox board, insert the radial-aerator into the PCIe slot number 5 from the left. A radial-aerator is mandatory as the video board reaches high temperatures during operation.
6. *Optional:* Insert the [Matrox](#) video board into the PCIe2 slot number 9 from the left.
7. Tidy up all cables and close the computer's casing.
8. Connect the computer's monitor to the graphics card in slot 3 from the left.
9. Start the machine and in the BIOS (Advanced: Thermal – Full Fan speed) set all fans to run at full speed.
10. Boot and log on to the machine.
11. Install NVIDIA and Video board drivers.
12. Open the NVIDIA Control Panel, and click on System Information in the bottom left corner and check that both graphics cards are installed and run at PCIe x16 speed.
13. If you installed a Matrox board, open Matrox X.info from the system tray and check that the video board runs at PCIe x8 speed.

Note: Matrox DSX.LE cannot be mounted in the DL370 G6

Once the machine is powered up you may verify that the Matrox X.mio board has been correctly installed by looking for the blue OB-light on the (top) backside of the slot panel. A lit light indicates that the board is correctly supplied with power.

To Setup an HP DL370 G6 with a capture card

PCI and PCIe slots, HP DL370 G6

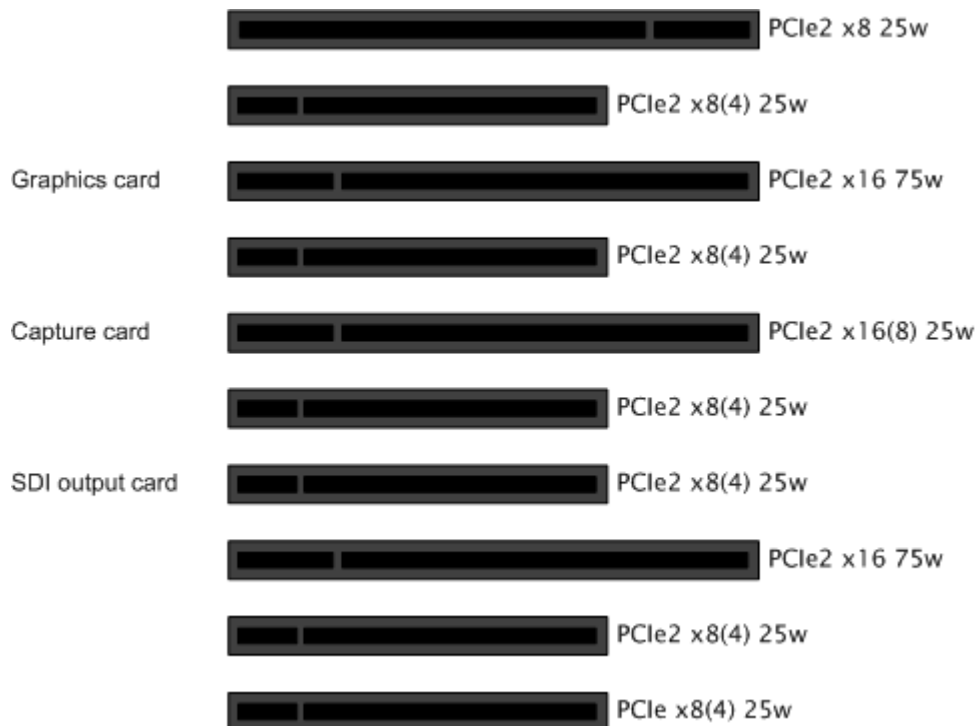

IMPORTANT! Before touching any components make sure you use an anti-static wrist strap to prevent electrostatic discharge.

1. Disconnect the power and all other peripherals.
2. Insert the graphics card in PCIe2 slot number 8 from the left.
3. Insert the capture card in PCIe2 slot number 6 from the left.
4. Insert the SDI output board in the PCIe2 slot number 4 from the left.
5. Tidy up all cables and close the computer's casing.

To Configure the BIOS

1. Start the machine and open the machine's BIOS system.
2. Go to **System Options > Processor Options**.
3. Deactivate **Hypertexting**. The Matrox X.mio2 board does not function if this setting is enabled.
4. Deactivate Intel **Virtualization Technology**.

5. Deactivate Intel VT-d2.

Note: Steps 2 and 3 are only needed for VMWare setups

6. Go to **Power Management Options > Advanced Power Management Options > PCI Express Generation 2.0 Support**.
7. Activate **Force PCI-E Generation 2**.
8. **Save and exit** the BIOS.

HP xw8200

This section describes how to setup a HP xw8400 machine with the different cards provided by Vizrt.

To Setup an HP xw8200

PCI, PCIe and PCI-X slots, HP xw8200

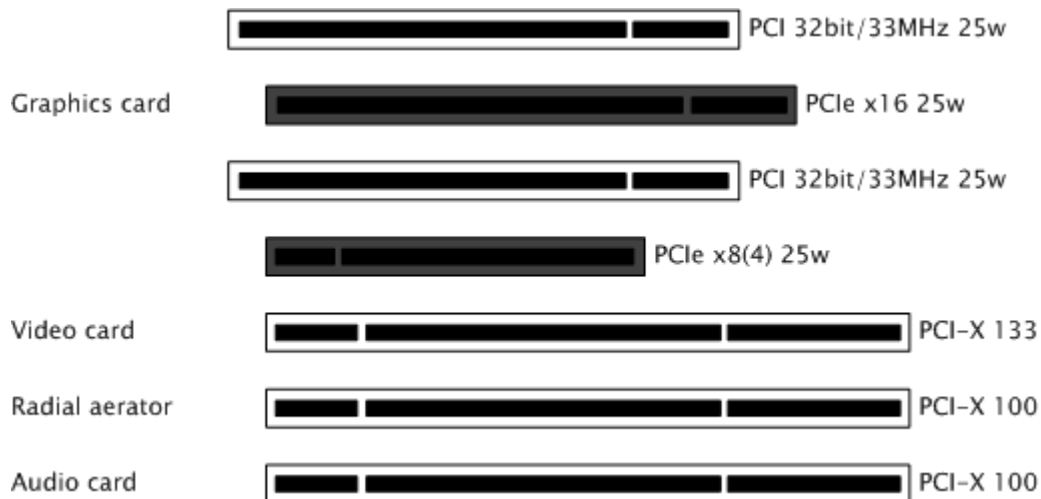

IMPORTANT! Before touching any components make sure you use an anti-static wrist strap to prevent electrostatic discharge.

1. Disconnect the power and all other peripherals.
2. Insert the graphics card in the PCIe slot number 2 from the top.
3. Insert the Matrox video board into the PCI-X slot number 4 from the top.
4. Insert a powerful radial-aerator into the PCI-X slot number 6 from the top.
5. Optional: Insert the [Matrox](#) video board into the PCI slot number 7 from the top.

Note: A radial-aerator is mandatory as the video board reaches high temperatures during operation.

Once the machine is powered up you may verify that the Matrox X.mio board has been correctly installed by looking for the blue OB-light on the (top) backside of the slot panel. A lit light indicates that the board is correctly supplied with power.

HP xw8400

This section describes how to setup a HP xw8400 machine with the different cards provided by Vizrt.

To Setup an HP xw8400

SATA plug, HP xw8400



IMPORTANT! Before touching any components make sure you use an anti-static wrist strap to prevent electrostatic discharge.

1. Disconnect the power and all other peripherals.
2. Before mounting the video board, the SATA connector originally connected to the SATA port 0 needs to be reconnected to SATA port 1 to make room for the video board.



Note: For an HP xw8400, the X.mio24/6000 video board. Insert the Matrox video board into the PCI-X slot number 6d requires a 64-bit PCI-X slot operating at a minimum of 100 MHz.

3. Insert the graphics card in the PCIe slot number 2 from the top.
4. from the top.
5. Insert a powerful radial-aerator into the PCI-X slot number 7 from the top.
6. *Optional:* Insert the [Matrox](#) video board into the PCI-X slot number 5 from the top.

Note: A radial-aerator is mandatory as the video board reaches high temperatures during operation.

Once the machine is powered up you may verify that the Matrox X.mio board has been correctly installed by looking for the blue OB-light on the (top) backside of the slot panel. A lit light indicates that the board is correctly supplied with power.

HP xw8600

This section describes how to setup a HP xw8600 machine with the different cards provided by Vizrt.

To Setup an HP xw8600 with a DVS Centaurus board

PCI-X, PCI and AGP slots, HP xw8600

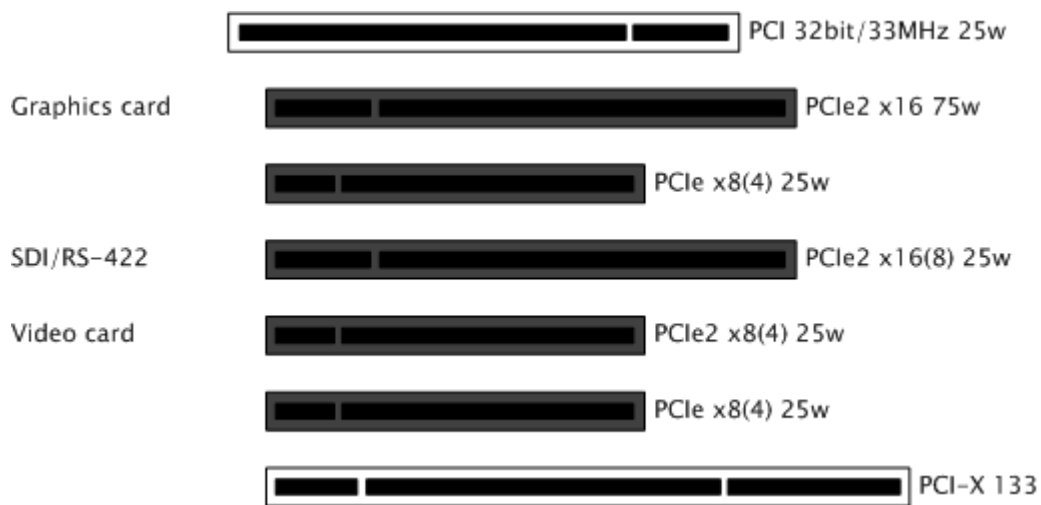

IMPORTANT! Before touching any components make sure you use an anti-static wrist strap to prevent electrostatic discharge.

1. Disconnect the power and all other peripherals.
2. Install the graphics card in slot number 2 from the top.
3. Install the video board in slot number 4 from the top.
4. Install the separate SDI/RS-422 panel in slot number 1 from the top. Make sure that the cable connections are properly mounted and that it stays clear of any supplemental aerators or the aerator of the graphics device.

To Setup an HP xw8600 with a X.mio2/X.mio2plus Matrox board

PCI, PCIe and PCI-X slots, HP xw8600

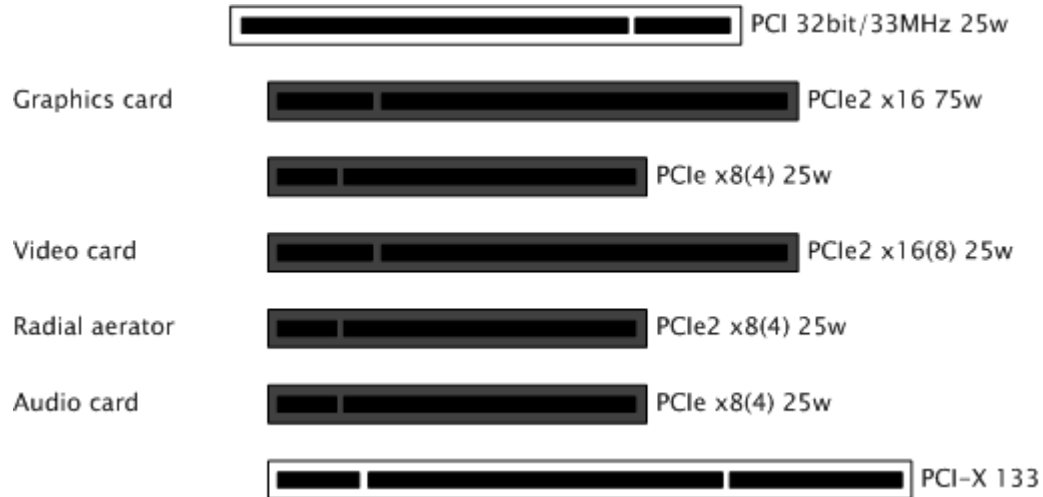

IMPORTANT! Before touching any components make sure you use an anti-static wrist strap to prevent electrostatic discharge.

1. Disconnect the power and all other peripherals.
2. Insert the graphics card in the PCIe slot number 2 from the top.
3. Insert the [Matrox](#) video board in the PCIe slot number 4 from the top.
4. Insert a powerful radial-aerator in the PCIe slot number 5 from the top.
5. *Optional:* Insert the [Matrox](#) video board in the PCI-X slot number 6 from the top.
6. *Optional:* Insert the extra slot panel for the X.mio2/44 board in any of the vacant slots, and connect it to the X.mio2 board.

Note: A radial-aerator is mandatory as the video board reaches high temperatures during operation.

To Setup an HP xw8600 with a X.mio (first gen) Matrox board

PCI, PCIe and PCI-X slots, HP xw8600

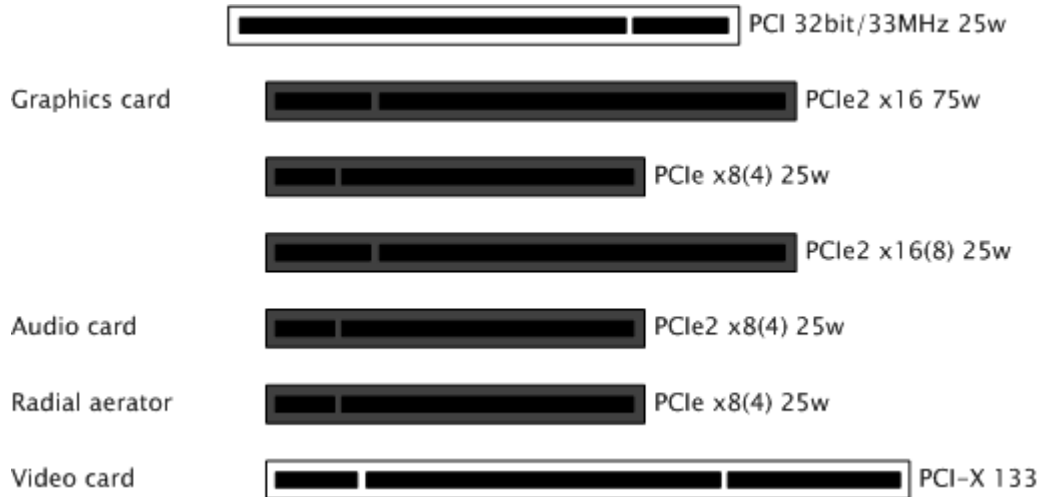

⚠ IMPORTANT! Before touching any components make sure you use an anti-static wrist strap to prevent electrostatic discharge.

1. Disconnect the power and all other peripherals.
2. Insert the graphics card in the PCIe slot number 2 from the top.
3. Insert the [Matrox](#) video board into the PCIe slot number 7 from the top.
4. Insert a powerful radial-aerator into the PCIe slot number 6 from the top.
5. Optional: Insert the [Matrox](#) video board into the PCI-X slot number 5 from the top.

⚠ Note: A radial-aerator is mandatory as the video board reaches high temperatures during operation.

Once the machine is powered up you may verify that the Matrox X.mio board has been correctly installed by looking for the blue OB-light on the (top) backside of the slot panel. A lit light indicates that the board is correctly supplied with power.

LPT Controller for a Viz License Dongle

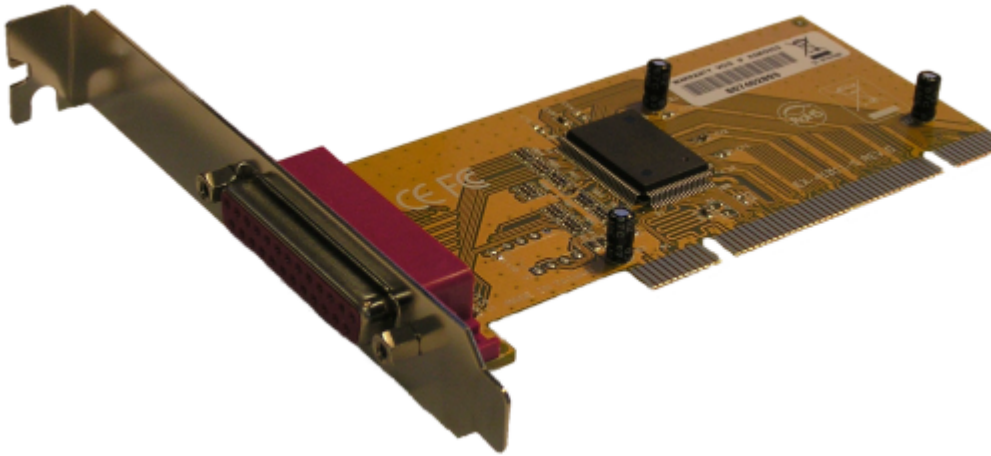

To provide recent render engines of type HP xw8600 with support for parallel dongles, an additional LPT controller card needs to be installed in the machine. For this purpose the topmost 32-bit PCI slot should be used.

To Install an LPT Controller Card

Adding the LPT controller card enables Viz to read the license from a parallel port dongle.

1. Power down the system and prepare it for hardware installation as documented in the manufacturer's manual(s).
2. Install the controller in the xw8600's topmost standard PCI (32-bit) slot.
3. Turn on the machine.
4. After the operating system has started up, insert the LPT controller driver disk and install as denoted in the manufacturer's documentation.
5. After installation has finished, do not modify any device configurations, but instead simply use the default settings automatically applied at installation time.

Supermicro SuperServer 7048 GR-TR

The dual-processor SuperServer 7048 GR-TR have excellent expansion capabilities and can be configured with up to four graphic cards. The chassis can be configured with tower top cover and feet as a desktop server, or as a 4U rack mountable chassis.



This section covers the following details:

- [GPU Installation](#)
- [BIOS Settings](#)

GPU Installation

The NVIDIA graphic cards must be installed with the first one at the bottom, furthest away from the CPU:

Slot	Card
CPU1 Slot2 PCI-E 3.0 x16	Graphic Card 1
CPU1 Slot4 PCI-E 3.0 x16	Graphic Card 2
CPU2 Slot6 PCI-E 3.0 x16	Graphic Card 3
CPU2 Slot8 PCI-E 3.0 x16	Graphic Card 4
CPU1 Slot10 PCI-E 3.0 x8 (in x16)	Matrox card

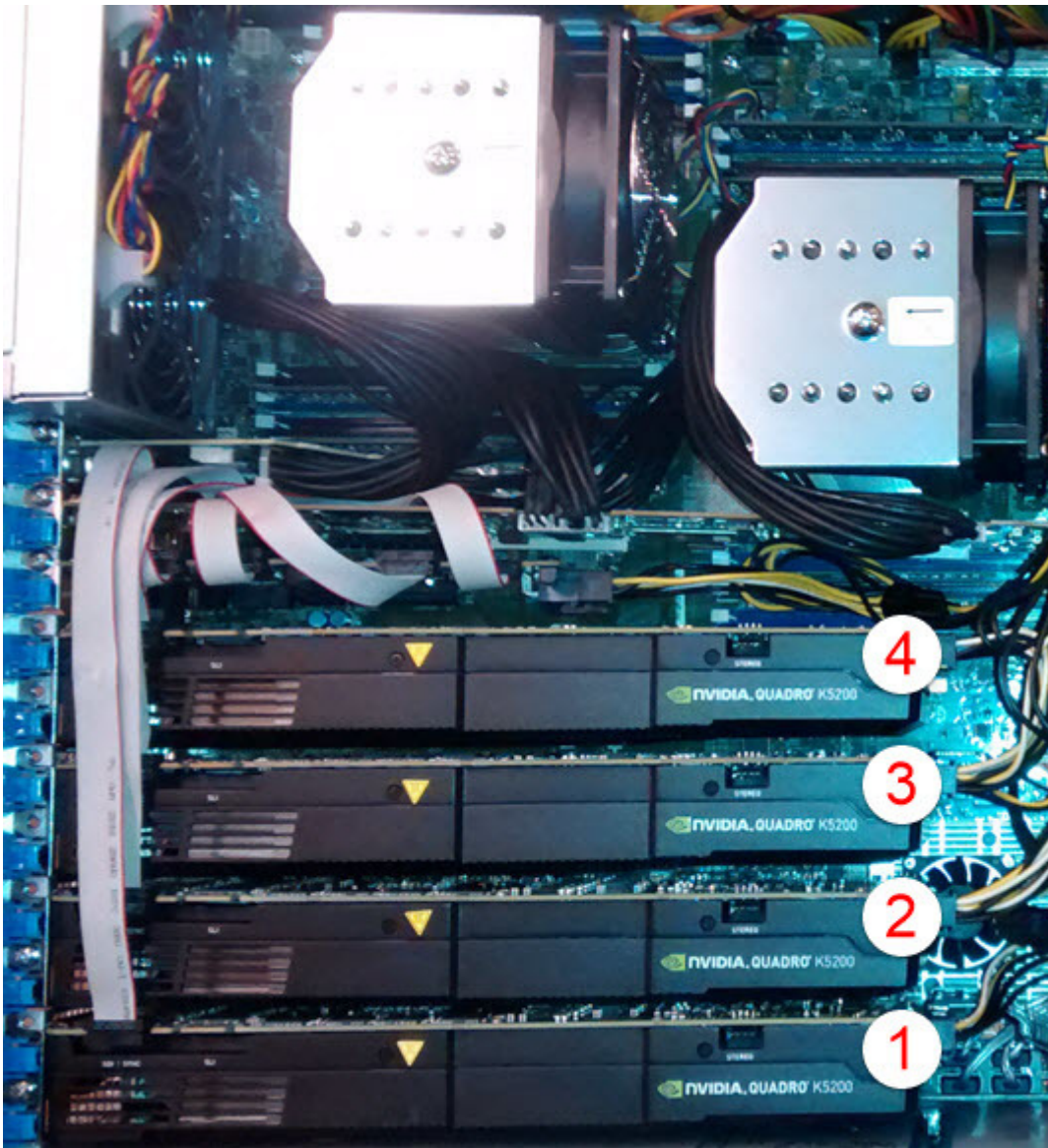

Also, make sure that the onboard GPU is disabled by setting the **JPG1** jumper to pins 2 and 3:

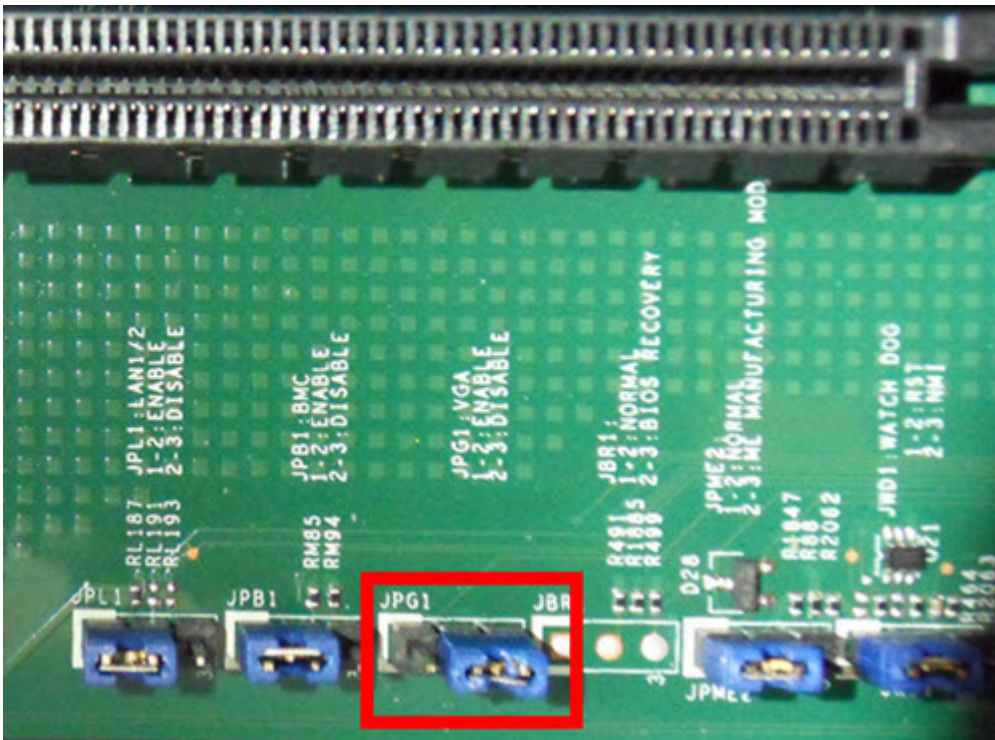

BIOS Settings

Setting	Value
Advanced > CPU Configuration Hyper-Threading (All)	Disabled
Advanced > Chipset Configuration > North Bridge > QPI Configuration > QPI General Configuration > Early Snoop	Disabled
Advanced > CPU Configuration > Advanced Power Management Configuration:	
Power Technology	Disabled
Energy Performance Tuning	Disabled
Energy BIAS Setting	Performance
Energy Efficient Turbo	Disabled

5.5.2 Deprecated Video Boards

The following chapter lists the configuration and additional information on deprecated video I/O hardware. The information in these sections is for historical reference only.

This section contains information on the following topics:

- [BlueFish444 Epoch 2K Horizon](#)
- [BlueFish444 IridiumSD](#)
- [BlueFish444 SD Lite Pro Express](#)
- [Digital Voodoo D1 Desktop](#)
- [Digital Voodoo DeepBlue LT](#)
- [Digital Voodoo Red Devil V3](#)
- [DVS Atomix HDMI](#)
- [DVS Atomix LT](#)
- [DVS Centaurus II](#)
- [Matrox X.Open](#)
- [NVIDIA Quadro SDI Capture](#)
- [Pinnacle Targa 3200](#)

BlueFish444 Epoch 2K Horizon

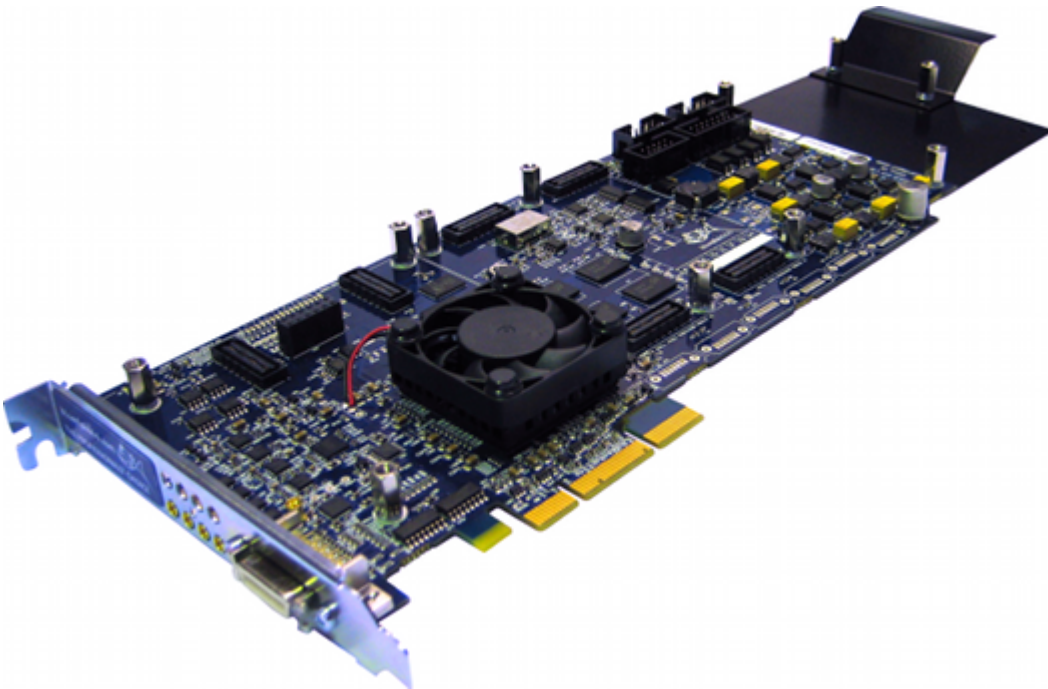

The BlueFish444 Epoch 2K Horizon board is intended for character generators such as Viz Trio, but can also be used as an alternative where only two inputs and outputs are required. The boards are typically installed on HP Z800 machines.

Configuration History

Use the driver version available on Vizrt's FTP server to make sure of correct functionality and ringbuffer support.

- 3.6.3, driver version Bluefish444 v5.10.2.18
- 3.6.1 - 3.6.2, driver version Bluefish444 v5.10.2.4
- 3.5.1 - 3.5.4, driver version Bluefish444 v5.10.1.11

- 3.5.0, driver version Bluefish444 v5.9.0.78

BlueFish444 IridiumSD

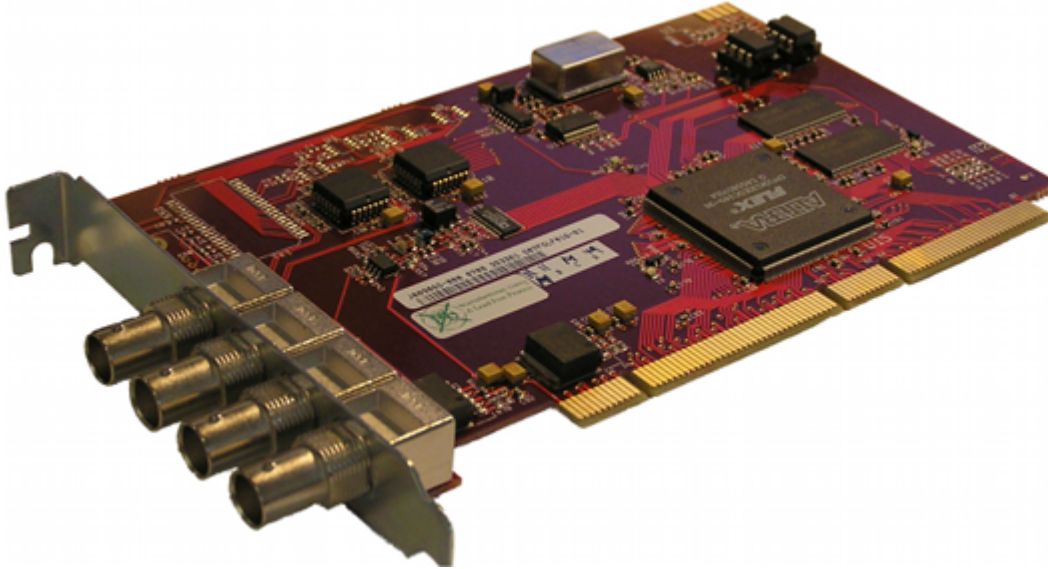

BlueFish444 Iridium|SD is the native successor of the Digital Voodoo DeepBlue LT and the predecessor of BlueFish444 SD Lite Pro Express, providing Fill, Key, GenLock and Composite Fill connectors. The Iridium|SD is fully compatible with older DeepBlue-LT installations.

The card was mostly used with Viz Trio NV which basically was a system with the ability to run a Viz Trio client with local preview and video output on a single machine; hence, there was no video input or video playback support as with the Matrox X.mio Series. The local preview was able to render a different scene than the one being output on video. The card was typically seen on HP xw4600.

IMPORTANT! Supports for the Iridium|SD card ended with Viz Engine 3.5. For supported versions, see the most recent BlueFish444 cards.

Connectors

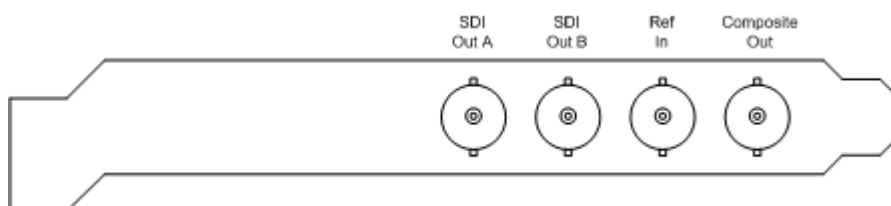

The BNC connectors from left to right are:

- **SDI Out A (Fill)** - SDI 4:2:2/4:4:4/Video
- **SDI Out B (Key)** - SDI 4:2:2/4:4:4/Video
- **Ref In** - Analog GenLock input
- **Composite Out** - Composite fill output

Driver Installation

The driver installation works the same way as for DeepBlue-LT cards. Use driver versions available on the Vizrt FTP server to make sure of correct functionality and ring buffer support.

Iridium|SD is fully compatible with existing DeepBlue-LT installations and can be used with any recent Viz version supporting the older DeepBlue-LT device.

⚠ Caution: Only Bluefish444 v3.1 is guaranteed to support an adequate ringbuffer size. Any other driver reduces or completely disables ringbuffer support.

Viz Artist/Engine Version	Driver
3.6.3	Bluefish444 v5.10.2.18
3.6.1	Bluefish444 v5.10.2.4
3.5.1	Bluefish444 v5.10.1.11
3.5	Bluefish444 v5.9.0.78
3.2.7	Bluefish444 v5.9.0.25
3.2.2	Bluefish444 v5.7.6
3.1.0-3532	Bluefish444 v3.1

⚠ Note: Viz Engine 3.2.7 and 3.3.0 require the Bluefish444 v5.9.0.25 driver for all Digital Voodoo / Bluefish cards.

BlueFish444 SD Lite Pro Express

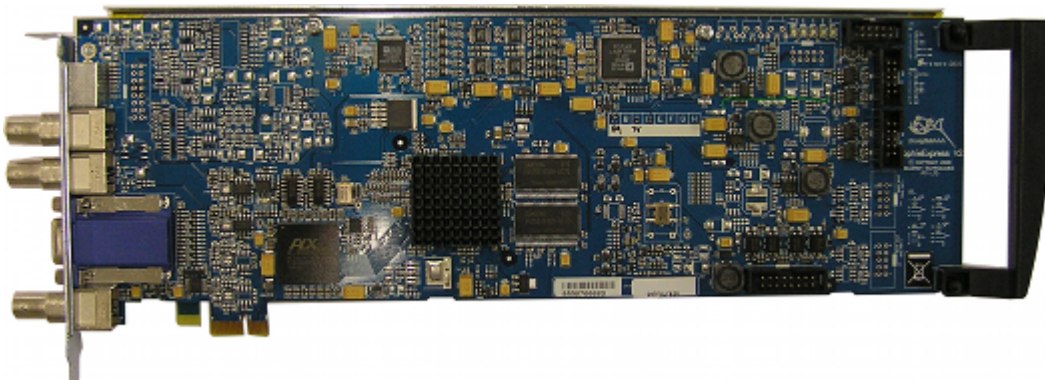

BlueFish444 SD Lite Pro Express provides Fill, Key and GenLock connectors, and is the successor of

the BlueFish444 Iridium|SD and the Digital Voodoo DeepBlue LT, that are no longer officially supported.

The card was mostly used with Viz Trio NV which basically was a system with the ability to run a Viz Trio client with local preview and video output on a single machine; hence, there was no video input or video playback support as with the Matrox X.mio Series. The local preview was able to render a different scene than the one being output on video. The card was typically seen on HP xw4600 workstations.

This section contains information on the following topics:

- [Connectors](#)
- [Driver Installation](#)

Connectors

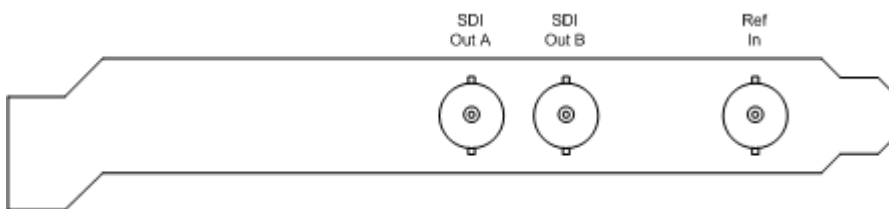

The BNC connectors from left to right are:

- **SDI Out A (Fill):** SDI 4:2:2/4:4:4/Video
- **SDI Out B (Key):** SDI 4:2:2/4:4:4/Video
- **Ref In:** Analog GenLock input

Driver Installation

Use the driver version available on Vizrt's FTP server to make sure of correct functionality and ringbuffer support.

Viz Artist/Engine Version	Driver
3.6.3	Bluefish444 v5.10.2.18
3.6.1	Bluefish444 v5.10.2.4
3.5.1	Bluefish444 v5.10.1.11
3.5	Bluefish444 v5.9.0.78
3.2.7	Bluefish444 v5.9.0.25
3.2.2	Bluefish444 v5.7.6

⚠ Note: Viz Engine 3.2.7 and 3.3.0 require the Bluefish444 v5.9.0.25 driver for all Digital Voodoo / Bluefish cards.

Digital Voodoo D1 Desktop

Digital Voodoo D1 Desktop was an older standard definition card that was rarely used, except sometimes with older machines such as IBM Z-Pro 6221, IBM 6223 or HP xw8200.

IMPORTANT! Support for the D1 Desktop card ended with Viz Engine 3.5. For supported versions, see the most recent BlueFish444 cards.

Configuration History

Viz Artist/Engine Version	Driver
Up to Viz 3.5	VizrtVideo 2.3 (Revision - V1 and V2)

Caution: Older card revisions (V1) are incompatible with recent systems like HP xw8200, xw8400, and IBM Z-Pro 6223. Symptoms are BSOD, machine freeze at Viz startup or corrupted live-video in Viz.

See Also

- [BlueFish444 SD Lite Pro Express](#)
- [BlueFish444 IridiumSD](#)

Digital Voodoo DeepBlue LT

Digital Voodoo DeepBlue LT was used for standard definition Viz Trio No Video systems, typically on HP xw4200, xw4300 or xw4400 workstations.

IMPORTANT! Support for the DeepBlue LT card ended with Viz Engine 3.5. For supported versions, see the most recent BlueFish444 cards.

Caution: Only BlueFish444 v3.1 is guaranteed to support an adequate ringbuffer-ize. Any other driver reduces or completely disables ringbuffer support.

Configuration History

Viz Artist/Engine Version	Driver
3.6.3	Bluefish444 v5.10.2.18
3.6.1	Bluefish444 v5.10.2.4
3.5.1	Bluefish444 v5.10.1.11

Viz Artist/Engine Version	Driver
3.5	Bluefish444 v5.9.0.78
3.2.7	Bluefish444 v5.9.0.25
3.2.2	Bluefish444 v5.7.6
3.1.0-3525	BlueFish444 v3.1

Note: Viz Engine 3.2.7 and 3.3.0 require the Bluefish444 v5.9.0.25 driver for all Digital Voodoo / Bluefish cards.

See Also

- [BlueFish444 SD Lite Pro Express](#)
- [BlueFish444 IridiumSD](#)

Digital Voodoo Red Devil V3

Digital Voodoo Red Devil V3 alias IO/2020 was used for SD virtual sets and Viz Arena, typically on IBM Z-Pro 6221, IBM ZPro 6223, or HP xw8200 machines.

IMPORTANT! Support for the Red Devil card ended with Viz Engine 3.5. For supported versions, see the most recent BlueFish444 cards.

Configuration History

Viz Artist/Engine Version	Driver
Up to Viz 3.5	VizrtVideo 2.3 (Revision - V3)

See Also

- [DVS Centaurus II](#)
- [DVS support](#)

DVS Atomix HDMI

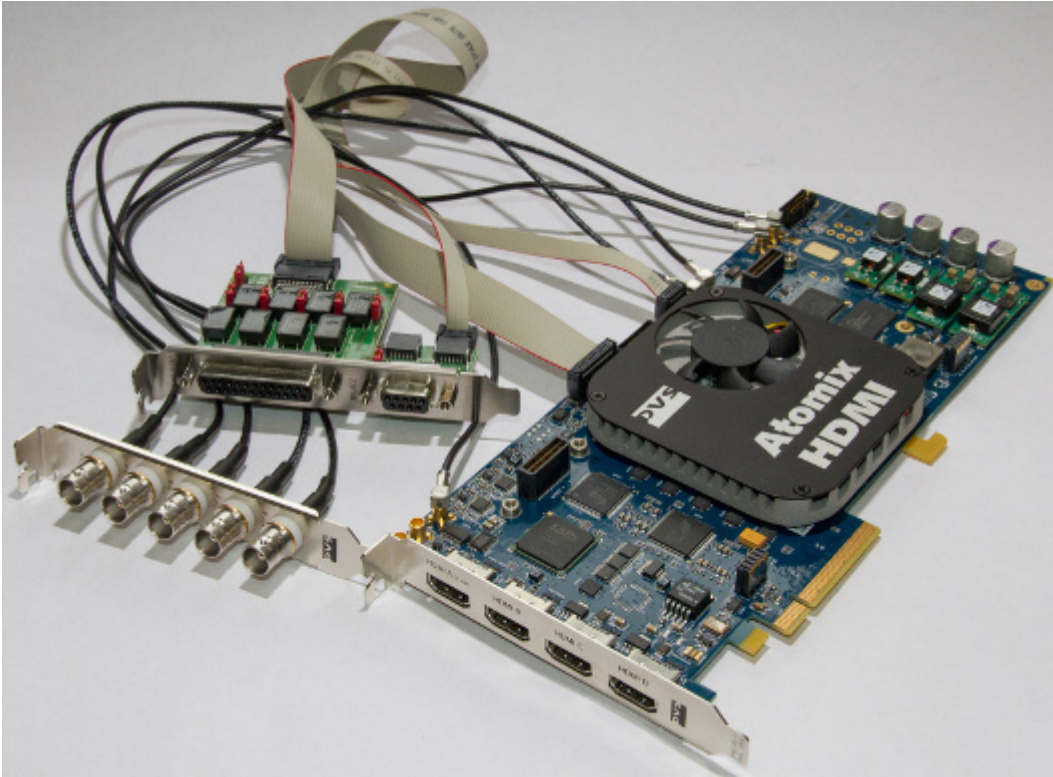

This section contains a description of the Digital Video Systems' (DVS) Atomix HDMI video board.

Atomix HDMI is designed for HD TV broadcast and film post production up to 2K. Atomix HDMI features two video channels that can be used independently or in 3D/stereo mode up to 2K. Moreover, it has an up/downscaler, a 1D LUT and multi-rate SDI ports with 3.0 Gbps which can be used in various single- and dual-link configurations. The DVS Atomix HDMI is mainly used with Viz Virtual Set and Viz Arena, and is the successor of the DVS Centaurus II. The DVS Atomix HDMI is, as with the Centaurus II, able to output SD, HD and 2K. The DVS Atomix HDMI is typically mounted in HP Z420 machines.

This section contains information on the following topics:

- [Connectors](#)
 - [Component Side](#)
 - [SDI Panel](#)
 - [Audio and RS-422 Panel](#)
- [Supported Codecs](#)
- [Configuration History](#)
- [Licensing](#)

Connectors

Component Side

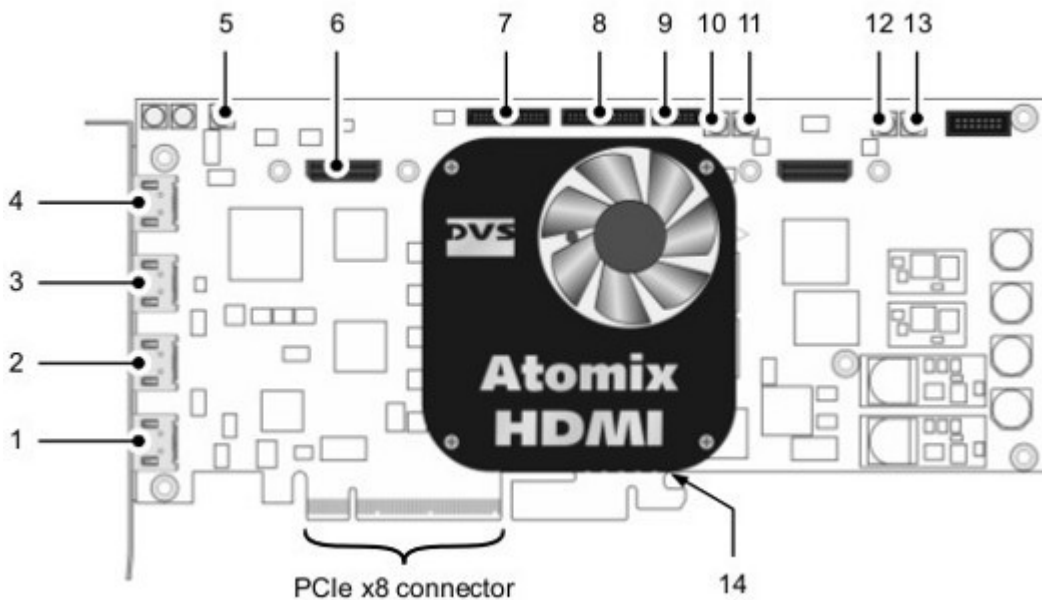

This section is an excerpt from the **DVS Atomix HDMI Installation Guide (version 2)**, section 2.2.2, *Overview of the Component Side*, and section 2.3.3, *Audio and RS-422 Panel*. For complete information, see the DVS Installation Guide available for download on their website.

No.	Item	Description
1	HDMI D	HDMI 1.3 connector for an output of digital audio and video signals; is used for the first video channel in special rasters (e.g. for quad-display applications)
2	HDMI C	HDMI 1.3 connector for an output of digital audio and video signals (main port of the assigned video channel); usually used for the second video channel; can also be used for the first video channel in special rasters (e.g. for quad display applications)
3	HDMI B	HDMI 1.3 connector for an output of digital audio and video signals; is used for the first video channel in special rasters (e.g. for quad-display applications)
4	HDMI A (1.4a)	HDMI 1.4a connector for an output of digital audio and video signals up to 4K (main port of the assigned video channel); usually used for the first video channel
5	Ref In	MXC connector for the reference input

No.	Item	Description
6	Expansion	Connection for an expansion module or slot panel
7	AUDIO 1-8/ LTC	Flat cable connector for analog audio, the digital audio channels 1 to 8 and LTC
8	AUDIO 9-16	Flat cable connector for the digital audio channels 9 to 16
9	RS-422 A/B	Flat cable connector for an in- and output of RS-422 signals (main remote ports)
10	SDI OUT A	MCX connector for an output of digital video signals (serial digital interface, port A); usually used for an output of the first video channel in single-link (YUV) or dual-link modes (either 3-Gbit/s SDI or first dual-link stream of YUVA or RGB[A])
11	SDI IN A	MCX connector for an input of digital video signals (serial digital interface, port A); usually used for an input of the first video channel in single-link (YUV) or dual-link modes (either 3-Gbit/s SDI or first dual-link stream of YUVA or RGB[A])
12	SDI IN B	MCX connector for an input of digital video signals (serial digital interface, port B); usually used for an input of the second video channel in single-link (YUV) or dual-link modes (3-Gbit/s SDI); can also be used for the first video channel for the second dual-link stream of YUVA or RGB[A]
13	SDI Out B	MCX connector for an output of digital video signals (serial digital interface, port B); usually used for an output of the second video channel in single-link (YUV) or dual-link modes (3-Gbit/s SDI); can also be used for the first video channel for the second dual-link stream of YUVA or RGB[A]
14	breaking line	The printed circuit board provides at its bottom an extension void of any electrical parts; it may serve to stabilize the installation of the board in a computer system; when not needed or interfering, you can carefully break it off the circuit board at the breaking line

SDI Panel

The SDI panel provides the serial digital interface connectors for Atomix HDMI:

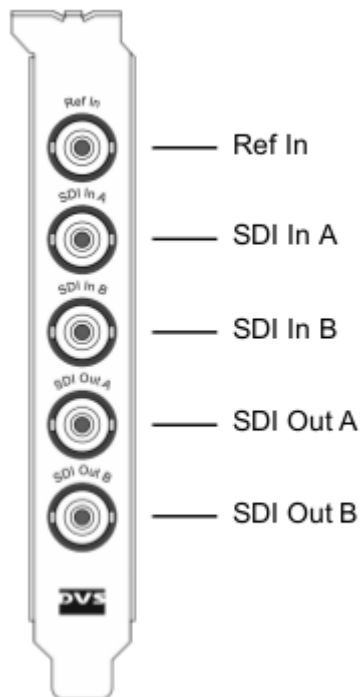

Item	Description
Ref In	BNC connector for the reference input
SDI In A	BNC connector for an input of digital video signals (serial digital interface, port A); usually used for an input of the first video channel in single-link (YUV) or dual-link modes (either 3-Gbit/s SDI or first dual-link stream of YUVA or RGB[A])
SDI In B	BNC connector for an input of digital video signals (serial digital interface, port B); usually used for an input of the second video channel in single-link (YUV) or dual-link modes (3-Gbit/s SDI); can also be used for the first video channel for the second dual-link stream of YUVA or RGB[A]
SDI Out A	BNC connector for an output of digital video signals (serial digital interface, port A); usually used for an output of the first video channel in single-link (YUV) or dual-link modes (either 3-Gbit/s SDI or first dual-link stream of YUVA or RGB[A])
SDI Out B	BNC connector for an output of digital video signals (serial digital interface, port B); usually used for an output of the second video channel in single-link (YUV) or dual-link modes (3-Gbit/s SDI); can also be used for the first video channel for the second dual-link stream of YUVA or RGB[A]

Audio And RS-422 Panel

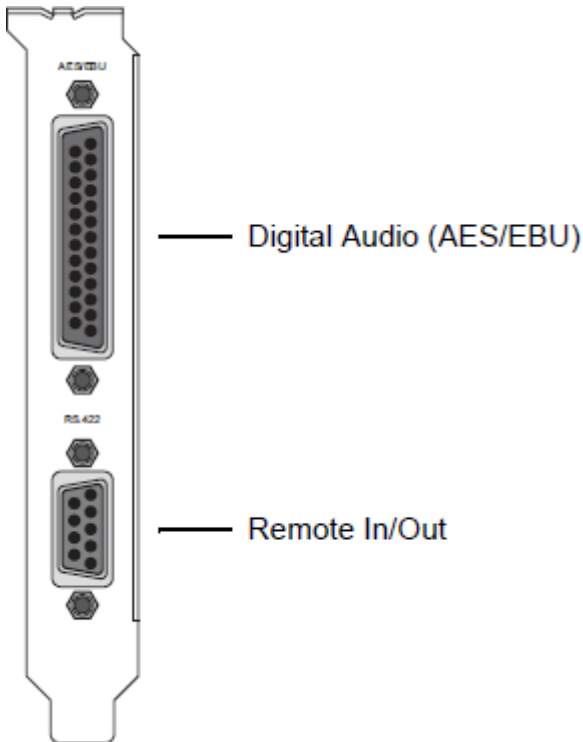

The board has the breakout cable, a RS-422 panel and cable. On the RS-422 panel there are two connectors:

Item	Description
Digital Audio (AES/EBU):	DB-25 connector (female) for audio and LTC in- and output; provides either four stereo channels digital audio (channels 1 to 8) or three channels audio plus LTC. It can also be used to provide the digital audio channels 9 to 16.
Remote In/Out:	DB-9 connector (female), serial RS-422 interface for master or slave control.

The breakout cable has 4 XLR male and 4 XLR female connectors to interface directly with audio devices. The RS-422 panel's cable is mounted on the back of the RS-422 panel's board and connected to the Atomix HDMI board.

Supported Codecs

Currently, the DVS Atomix HDMI implementation only supports the **Microsoft DirectShow Filtergraph** framework to render video clips. This enables play, for example, of MPEG files or streams from a server. Basically the DVS Atomix HDMI board can play everything that can be played out by the Windows Media Player, so it depends on what codecs/DirectShow filters that are installed on the machine.

For more information on how to use video clips in Viz Artist, see the [Viz Artist User Guide](#) and, in particular, the SoftClip and MoViz plug-ins.

Configuration History

Use the driver version available on Vizrt's FTP server to make sure of correct functionality and ringbuffer support.

The following driver versions are supported:

Viz Release	Driver Version
3.5.4 and later	SDK 4.3.5.10 (firmware7.4.0.20_7.0.10)
3.5.2 - 3.5.3	SDK 4.2.9.8 (firmware 7.4.0.6_7.0.10)

For information on how to install or update the driver, see the DVS SDK 2.7 User Guide (version 2.0) sections 3.2 and 3.3: *Installation under Windows* and *Updating an Existing SDK*.

Licensing

For information on how to set the license key for the DVS Atomix HDMI board, see the DVS Atomix HDMI installation guide, section 3.3: *Setting the License Key*.

See Also

- Supported Codecs in the Media Assets section of the [Viz Artist User Guide](#)
- [DVS support](#)

DVS Atomix LT

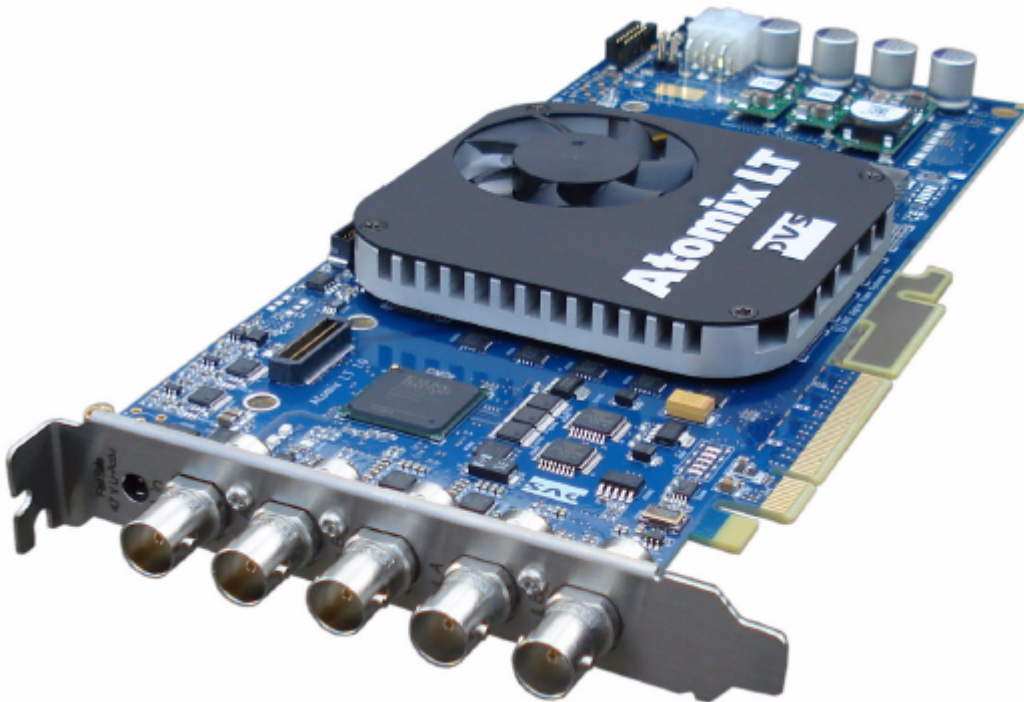

This section contains a description of the Digital Video Systems' (DVS) Atomix LT video board. Atomix LT is designed for HD TV broadcast and film post production up to 2K. Atomix LT features two video channels that can be used independently or in 3D/stereo mode up to 2K. Moreover, it has an up/downscaler, a 1D LUT and multi-rate SDI ports with 3.0 Gbps which can be used in various single- and dual-link configurations.

Use of the DVS is mainly used with Viz Virtual Set and Viz Arena, and is Vizrt's successor of the DVS Centaurus II. The DVS Atomix LT is as with the Centaurus II able to output SD, HD and 2K. The DVS Atomix is typically mounted in HP Z800 machines.

This section contains information on the following topics:

- [Connectors](#)
 - [Overview of the Items and Connectors on the DVS Atomix LT Board](#)
 - [Panel with Audio and Remote Control Connections](#)
- [Supported Codecs](#)
- [Configuration History for DVS](#)
- [Licensing](#)

Connectors

Overview Of The Items And Connectors On The DVS Atomix LT Board

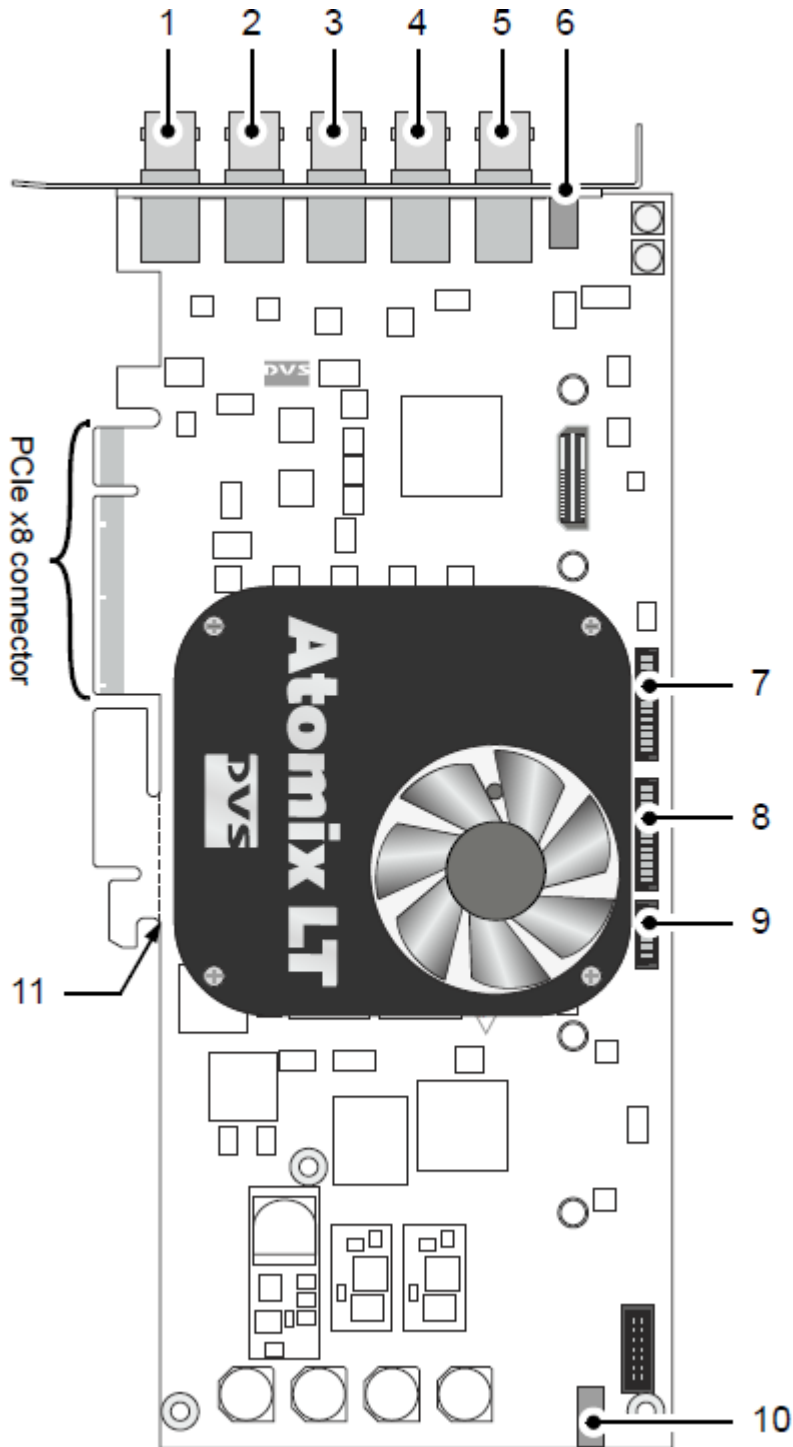

This section is an excerpt from the **DVS Atomix LT installation guide** (version 1.0) section 2.2.1

and 2.3.2: *Overview of the Component Side and Audio _and RS-422 Panel_*. For complete information, please refer to DVS' installation guide available for download on their website.

No.	Item	Explanation
1	SDI Out B	BNC connector for an output of digital video signals (serial digital interface, port B); usually used for an output of the second video channel in single-link (YUV) or dual-link modes (3-Gbit/s SDI); can also be used for the first video channel for the second dual-link stream of YUVA or RGB[A]
2	SDI Out A	BNC connector for an output of digital video signals (serial digital interface, port A); usually used for an output of the first video channel in single-link (YUV) or dual-link modes (either 3-Gbit/s SDI or first dual-link stream of YUVA or RGB[A])
3	SDI In B	BNC connector for an input of digital video signals (serial digital interface, port B); usually used for an input of the second video channel in single-link (YUV) or dual-link modes (3-Gbit/s SDI); can also be used for the first video channel for the second dual-link stream of YUVA or RGB[A]
4	SDI In A	BNC connector for an input of digital video signals (serial digital interface, port A); usually used for an input of the first video channel in single-link (YUV) or dual-link modes (either 3-Gbit/s SDI or first dual-link stream of YUVA or RGB[A])
5	Ref In	BNC connector for the reference input
6	Fail Safe 0	See Fail Safe 1
7	AUDIO 1-8/LTC	Flat cable connector for analog audio, the digital audio channels 1 to 8 and LTC
8	AUDIO 9-16	Flat cable connector for the digital audio channels 9 to 16
9	RS-422 A/B	Flat cable connector for an in- and output of RS-422 signals (main remote ports)
10	Fail Safe 1	For a bypass of the SDI input signals to the SDI outputs in case of power loss connect to either this connector or Fail Safe 0 a rechargeable battery (accu, see section "Technical Data" on page A-1)
11	Breaking line	The printed circuit board provides at its bottom an extension void of any electrical parts; it may serve to stabilize the installation of the board in a computer system; when not needed or interfering, you can carefully break it off the circuit board at the breaking line

Panel With Audio And Remote Control Connections

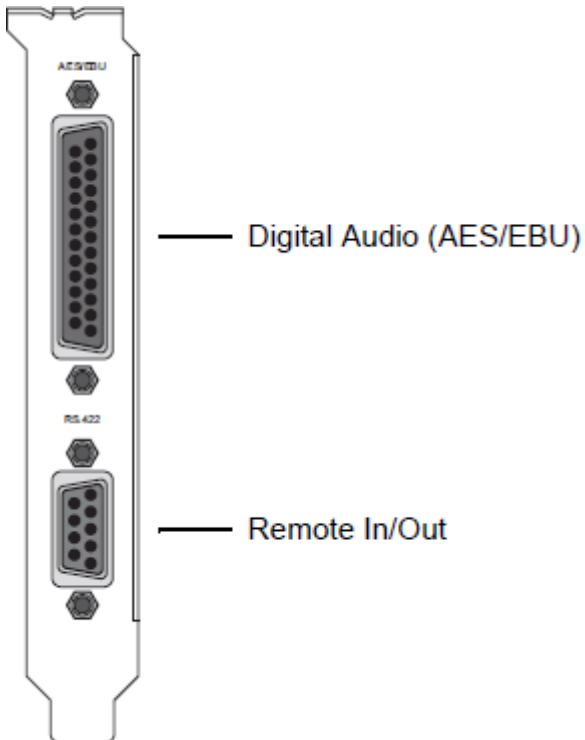

With the board you also have the breakout cable, RS-422 panel and cable. On the RS-422 panel there are two connectors, one DB-25 connector for digital audio (AES/EBU) and one DB-9 connector for remote in/out.

Item	Explanation
Digital Audio (AES/EBU)	DB-25 connector (female) for audio and LTC in- and output; provides either four stereo channels digital audio (channels 1 to 8) or three channels audio plus LTC; alternatively it can be used to provide the digital audio channels 9 to 16.
Remote In/Out	DB-9 connector (female), serial RS-422 interface for master or slave control.

The breakout cable has four XLR male and four XLR female connectors to interface directly with audio devices. The RS-422 panel's cable is mounted on the back of the RS-422 panel's board and connected to the Atomix LT board.

Supported Codecs

Currently, the DVS implementation only supports the **Microsoft DirectShow Filtergraph** framework to render video clips. This enables you to play for example MPEG files or streams from a server.

For more information on how to use video clips in Viz Artist, see the [Viz Artist User Guide](#), in particular the SoftClip and MoViz plug-ins.

Basically, the DVS board can play everything that can be played out by the Windows Media Player, so it depends on what codecs/DirectShow filters that are installed on the machine.

Configuration History for DVS

The following driver versions are supported:

Viz Release	Driver Version
3.5.4 and later	SDK 4.3.5.10
3.5.2 - 3.5.3	SDK 4.2.9.8
3.3.0 - 3.5.1	SDK 4.0.1.15

For information on how to install or update the driver, please refer to DVS' SDK 2.7 user guide (version 2.0) sections 3.2 and 3.3: *Installation under Windows* and *Updating an Existing SDK*.

Licensing

For information on how to set the license key for your DVS Atomix LT board, please refer to the DVS Atomix LT installation guide (version 1.0) section 3.3: *Setting the License Key*.

See Also

- [DVS support](#)

DVS Centaurus II

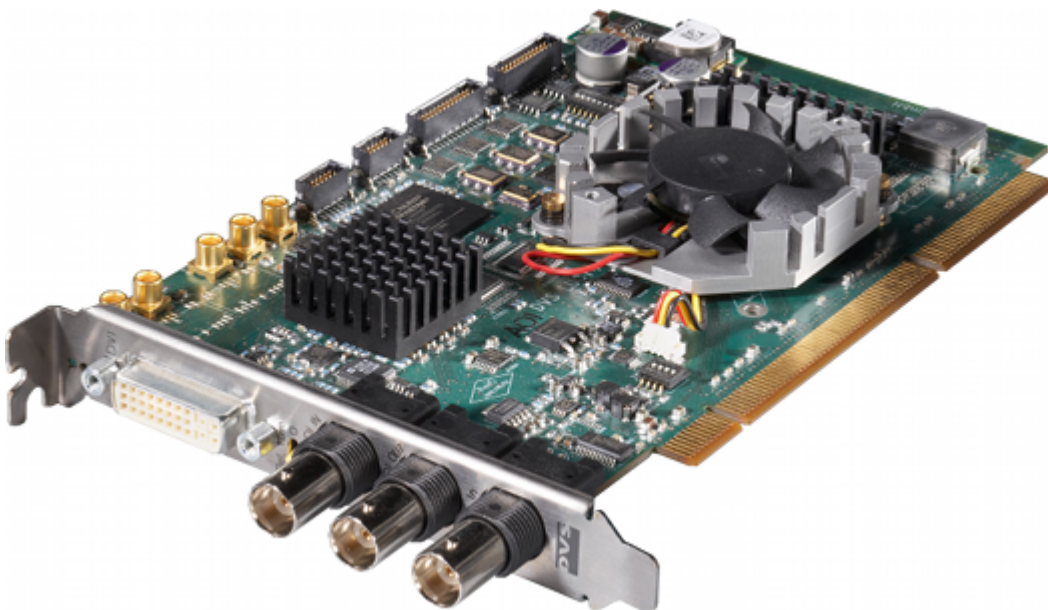

This section contains a description of the Digital Video Systems (DVS) Centaurus II video card. The DVS was mainly sold with Viz Virtual Set and Viz Arena, and was Vizrt's successor of the Digital

Voodoo Red Devil V3 card. The DVS is able to output both HD and SD unlike the Red Devil which could only output SD. The DVS was typically mounted in HP wx8400, HP xw8600 or HP Z800 machines.

This section contains information on the following topics:

- [Connectors](#)
 - [Main Card Connectors](#)
 - [Description of the LEDs on the Video Card](#)
 - [SDI and RS-422 Extension Card Connectors](#)
 - [To Connect the DVS Centaurus II and SDI/RS-422 Extension Card](#)
- [Supported Codecs](#)
- [Driver Installation](#)
- [Licensing](#)
 - [To Install a DVS Centaurus II License](#)
 - [To validate the DVS Centaurus II license](#)

Connectors

This section describes the main video card, the SDI/RS-422 extension card and how To Connect the DVS Centaurus II and SDI/RS-422 Extension Card.

This section contains information on the following topics:

- [Main Card Connectors](#)
- [SDI and RS-422 Extension Card Connectors](#)
- [To Connect the DVS Centaurus II and SDI/RS-422 Extension Card](#)

Main Card Connectors

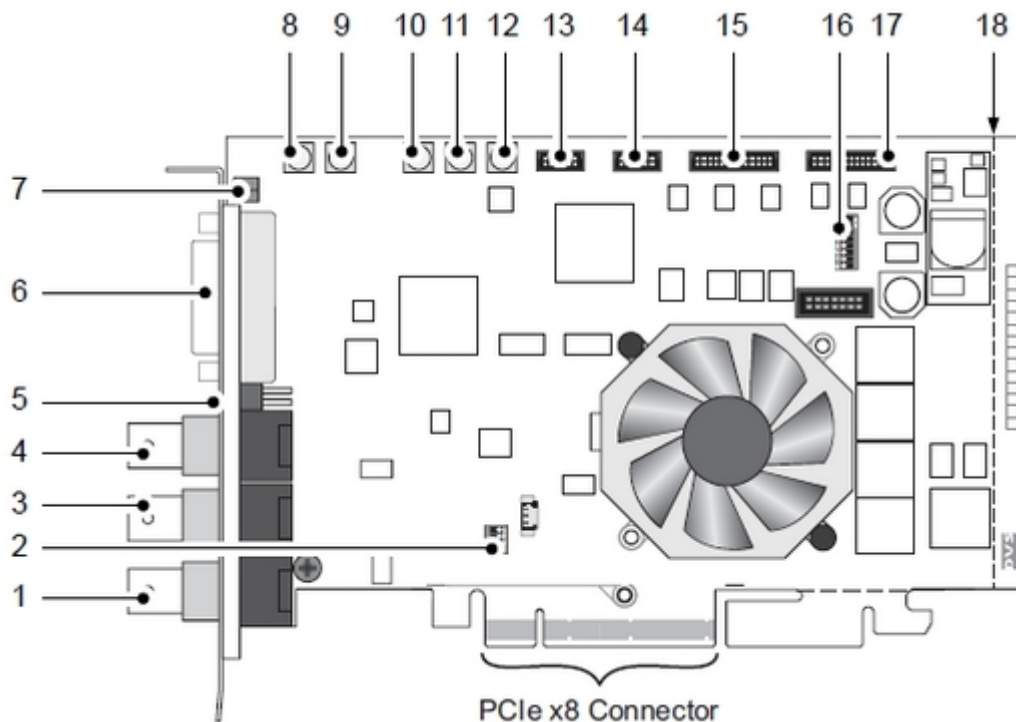

1. **Ref. In:** BNC connector for the reference input. May be Bi-/Tri-Level sync.
2. **DIP Switch for PCI:** PCI-X variant only: DIP switch to set up the PCI video card interface, that is its clock frequency; This switch is not available on the PCIe version of the card used by Vizrt.
3. **(HD) SDI OUT A:** BNC connector for a video output at port A (serial digital interface); usually used for an output of the first video channel in single-link (YUV) or the first stream of YUVA or RGBA in dual-link mode.
4. **(HD) SDI IN A:** BNC connector for a video input at port A (serial digital interface); usually used for an input of the first video channel in single-link (YUV) or the first stream of YUVA or RGBA in dual-link mode.
5. **Ref. Term:** Termination switch for the reference input; switches off the termination of the GenLock signal manually, for example if the Centaurus II card is not the last link in a GenLock connection chain.
6. **DVI OUT:** DVI connector for an output of analogue and digital video signals.
7. **LEDs:** Two status LEDs (Red/Green) indicating the presence of correct video and sync signals (see also Description of the LEDs on the video card).
8. **SD SDI IN1:** MCX connector for an input of digital SD video signals (serial digital interface)
9. **(HD) SDI IN B:** MCX connector for a video input at port B (serial digital interface); usually used for an input of the second video channel in single-link (YUV) or the second stream of YUVA or RGBA in dual-link mode.
10. **(HD) SDI OUT B:** MCX connector for a video output at port B (serial digital interface); usually used for an output of the second video channel in single-link (YUV) or the second stream of YUVA or RGBA in dual-link mode.
11. **SD SDI OUT1:** MCX connector for an output of digital SD video signals (serial digital interface)-
12. **CVBS OUT:** MCX connector for a composite video burst signal, either analogue output of SD video or used for synchronization purposes.

13. **GPI:** Flat cable connector for the general purpose interface.
14. **RS-422:** Flat cable connector for an in- and output of RS-422 signals
15. **AUDIO 1-8/LTC:** Flat cable connector for the digital audio channels 1 to 8 and LTC.
16. **DIP Switch for Flash Controller:** This switch controls the operation of the on-board Flash controller; it defines the version set of the map file that loads at startup. The image above depicts the default setting of the DIP switch for the Flash controller; please observe the orientation of the switch on the card.



17. **Audio 9-16:** Flat cable connector for the digital audio channels 9 to 16.
18. **Breaking line:** The printed circuit board provides at its bottom (PCIe variant only) and right side extensions void of any electrical parts; these may serve to stabilize the installation of the card in a computer system; when not needed or interfering, you can break them off the circuit board at the breaking line(s); see also dotted lines in figure 1 on the previous page.

Description Of The LEDs On The Video Card

LED	Function	Mode	Description
Green	Signals the status of the sync input	On	A correct sync signal is detected, that is:- Sync mode <i>internal</i> is set- Sync mode <i>external</i> is set and a correct signal is connected- Sync mode <i>analog</i> is set and an analog GenLock signal is connected- Sync mode <i>digital</i> is set and a correct signal is connected.
		Off	A wrong input signal is detected, i.e.: - Sync mode <i>external</i> is set and no SDI input signal. - Sync mode analog is set and no GenLock signal connected. - Sync mode digital is set and no SDI input signal.
Red	Signals the status of the video raster detection feature	Blinking slowly	No input signal is available.

LED	Function	Mode	Description
		Blinking fast	A wrong input signal is detected (for example DVS Centaurus II is set to NTSC video mode, but a PAL signal is connected to the active input).
		Off	A correct input signal is detected.

SDI And RS-422 Extension Card Connectors

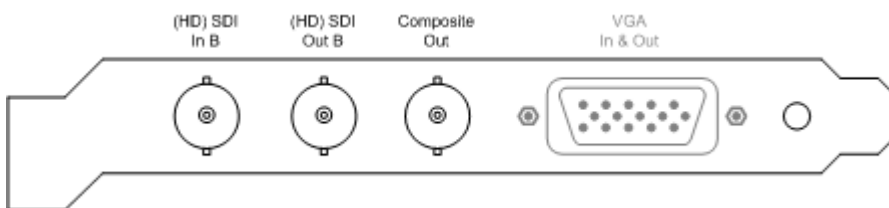

The SDI and RS-422 panel is included in the standard configuration of DVS Centaurus II. It provides the connectors for the second link of the dual-link connections. Additionally a CVBS output is installed on this panel that provides a composite video signal showing the fill signal generated by Viz Engine.

The RS-422 connector available on the panel is a DB-15 (HD) connector.

⚠ Note: This connector does not provide any additional functionality in regards to Viz Engine and should be ignored. The RS-422 port is not accessible to the operating system and can therefore not be used to transceive any kind of data by third-party applications.

- (HD) SDI In B: BNC connector for a video input at port B (serial digital interface); usually used for an input of the second video channel in single-link (YUV) or the second stream of YUVA or RGBA in dual-link mode.
- (HD) SDI Out B: BNC connector for a video output at port B (serial digital interface); usually used for an output of the second video channel in single-link (YUV) or the second stream of YUVA or RGBA in dual-link mode.
- CVBS Out: BNC connector for a composite video burst signal, either analogue output of SD video or used for synchronization purposes. Provides the fill output of Viz engine as an analogue signal.
- RS-422 In & Out: DB-15 (HD) connector (female), serial RS-422 interface for master/slave control, a breakout cable to two DB-9 connectors is included in the delivery.

⚠ Note: This RS-422 connector is inactive and not accessible to the OS and can therefore not be used to transceive data.

To Connect The DVS Centaurus II And SDI/RS-422 Extension Card

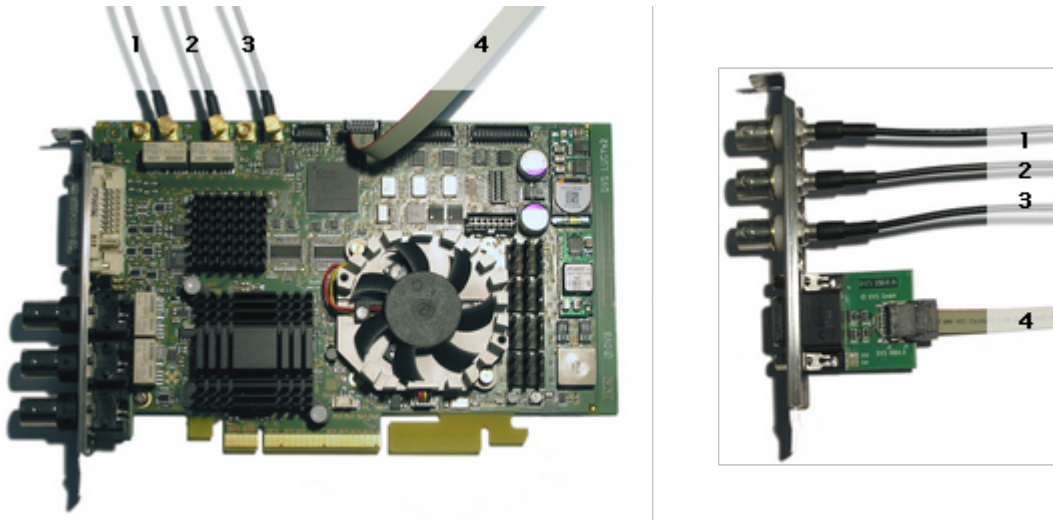

Connect the separate SDI/RS-422 panel with the DVS Centaurus II main card according to the enumeration shown in the illustration above.

Supported Codecs

Currently, the DVS implementation only supports the Microsoft DirectShow Filtergraph framework to render video clips. Therefore it is possible to play for example MPEG files or streams from a server. For more information on how to use video clips in Viz, see the Viz Artist manual and in particular the Mo Viz plug-in. Basically, it can play everything that can be played out by the Windows Media Player, so it depends on what codecs/DirectShow filters that are installed on the machine.

Driver Installation

The following driver versions are supported:

Viz Artist/Engine Version	Driver
3.5.4	SDK 4.3.5.10
3.5.2 - 3.5.3	SDK 4.2.9.8
3.3.0 - 3.5.1	SDK 4.0.1.15

For information on how to install or update the driver, see the DVS SDK 2.7 User Guide.

Licensing

A few additional steps are required before Viz Engine is able to use the DVS Centaurus II card after a first time installation. First it is necessary To Install a DVS Centaurus II License, and then To validate the DVS Centaurus II license.

Note: Licensing should not be an issue if the DVS Centaurus II card came pre installed with the Viz Engine machine.

Note: License information is stored in a memory region on the device itself and is not lost if the card is mounted on another computer.

The license key required during the installation process is shipped together with the device and comes as a single sheet of machine-written paper looking something like the illustration below:

```

lic<xxxxx>.txt
-----Date: <xxxxx>
  Licenser: <xxxxx>
  Serialnumber: <xxxxx>
  License does not expire
    rawkey 1 = <xxxxx>
  rawkey 2 = <xxxxx>
  rawkey 3 = <xxxxx>
  To check licenses 'svram license show'
  For DDR type:
  sv license key1 <yyyyy>
  For OEM type:
  svram license key1 <yyyyy>
-----
# Product: Centaurus 2 PCIe
# License Key Options:
#
# Not-Expire
#
# Centaurus 2-Dual-Link
# Centaurus 2-Multi-Channel
-----
Page 1

```

To Install A DVS Centaurus II License

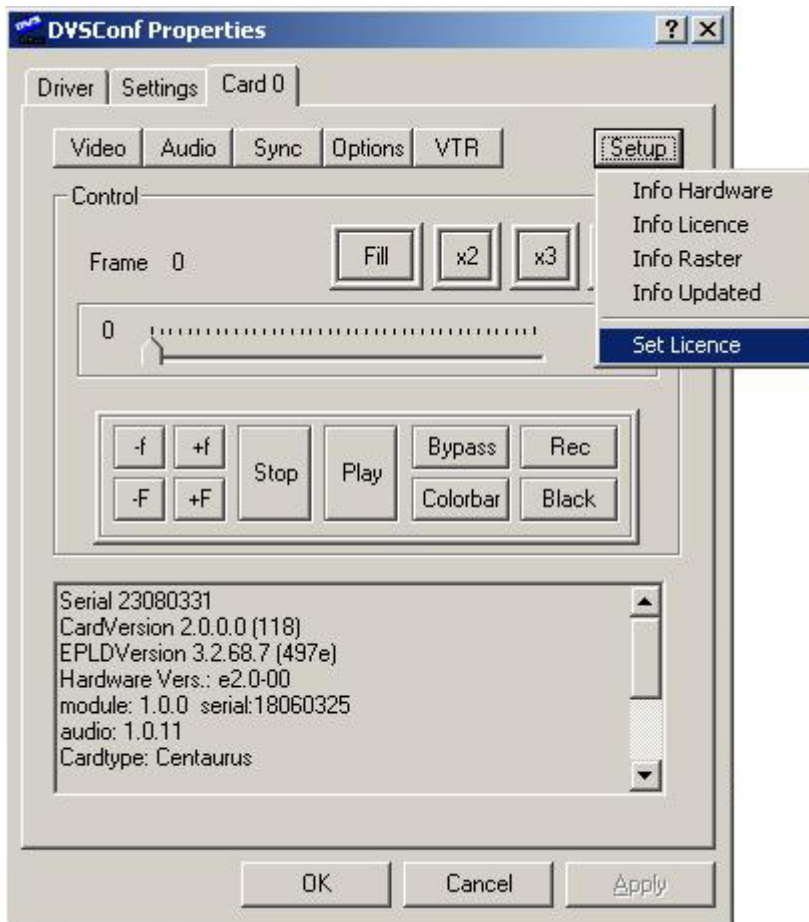

1. Locate and double-click the *dvsconfig.exe* file located in the driver folder downloaded from the [Vizrt FTP server](#).
2. Select the **Card 0** tab. When selecting the **Card 0** tab for the first time the system informs that a license needs to be installed for the product.
3. Click **OK** to close the DVSConf Warning dialog box.

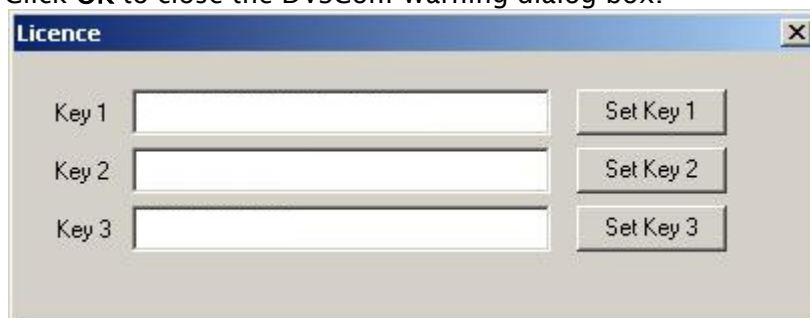

4. Click the **Setup** button and select *Set Licence* from the appearing drop-down menu.
5. Enter the license key in field *Key 1* and click the *Set Key 1* button.

⚠ Note: It has been reported that the key might be ignored and that validation fails although it was correctly entered. Re-enter the license string and try again.

To Validate The DVS Centaurus II License

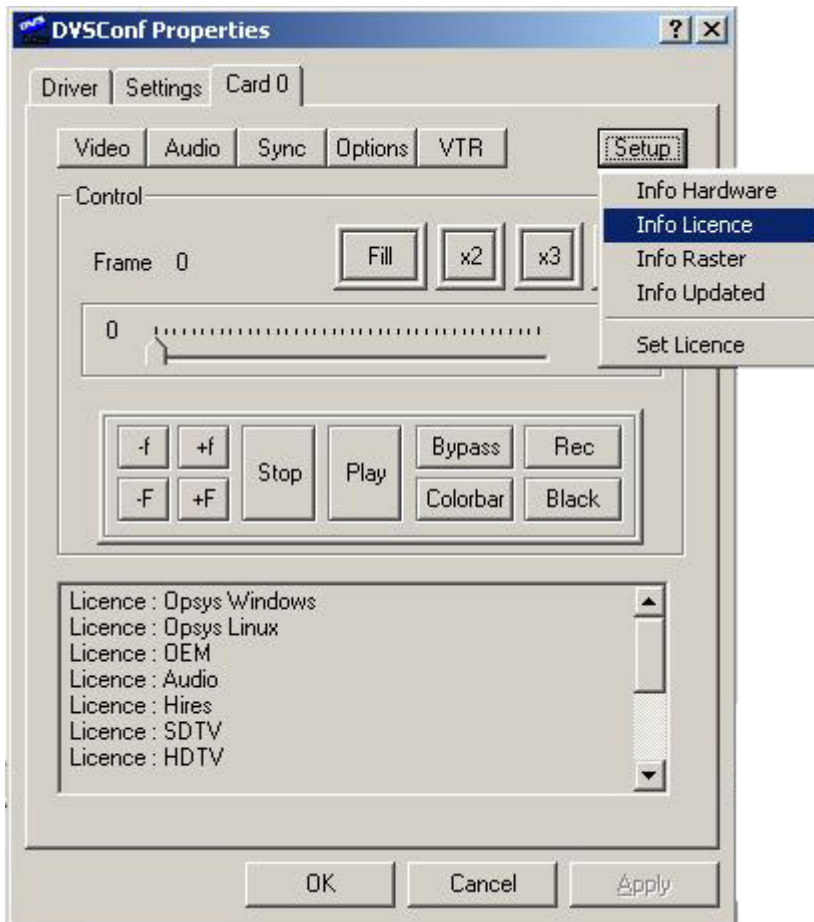

1. Locate and double-click the *dvsconfig.exe* file located in the driver folder downloaded from [Vizrt's FTP](#).
2. Select the **Card 0** tab.
3. Click the **Setup** button and select **Info License** from the appearing drop-down menu.
4. Check the following entries (bottom of the dialog box):
 - License: Opsy Windows
 - License: Opsy Linux
 - License: OEM
 - License: Multidevice
 - License: Audio
 - License: Hires
 - License: SDTV
 - License: HDTV
 - License: 12Bit
 - License: Processing
 - License: Mixer
 - License: ZoomAndPan
 - License: ColorCorrector

- License: HDTVKeyChannel
 - License: HDTVDualLink
 - License: SDTVKeyChannel
 - License: SDTVDualLink
5. Once all licenses are verified, click **OK** to close the program.

See Also

- [DVS support](#)

Matrox X.Open



Matrox X.Open is a USB dongle with no video outputs or inputs.

As there are no USB drivers available on Windows 10, it has been discontinued in Viz Engine 3.13.0.

NVIDIA Quadro SDI Capture



Currently the NVIDIA Quadro SDI Capture card can only be used with the NVIDIA SDI option. The Vizrt application of this card is mainly in time-critical environments like virtual studios and sports applications, as it has a stable latency from input to output (of four frames).

The time used for video transfer from input to the GPU and back to video output is a lot less than any other solution Vizrt currently offers. Hence, scenes with four video inputs as texture still have a lot of rendering time left per field/frame.

Connectors

The card has five BNC connectors. Four connectors are used for input, and the fifth connector serves as a loop-through of input one.

Drivers for NVIDIA Quadro SDI Capture Card

Use the latest NVIDIA GPU driver and WDM (Windows Driver Model) driver for the capture card. Vizrt does not recommend a specific driver version beyond using the latest version available from NVIDIA.

See Also

- Compatible and recommended NVIDIA SDI out cards supported by Vizrt:
 - NVIDIA Quadro FX 4400
 - NVIDIA Quadro FX 5500
 - NVIDIA Quadro K5000
- Available machine configurations:
 - HP DL370

Pinnacle Targa 3200

Pinnacle Targa 3200 was Vizrt's standard card for SD Viz systems until 2007, and was typically used with IBM ZPro 6221, IBM Z-Pro 6223 and HP xw8200.

Configuration History

Driver	Revision
CODI v2.42	3213. Revision 3213 crashes the machine when used with CODI v2.41rc13.
CODI v2.41rc13	3212, 3214. Installation of CODI Compatibility Patch for revision 3214 is no more required.
CODI v2.42	3212, 3213, 3214. Installation of CODI Compatibility Patch is required.
CODI v2.2 RC4	3212, 3213

See Also

- [Matrox X.mio Series](#)

5.5.3 Legacy Graphic Boards

This section details all legacy NVIDIA cards:

- [NVIDIA Quadro 6000](#)
- [NVIDIA Quadro 5000](#)
- [NVIDIA Quadro 4000](#)
- [NVIDIA Quadro 2000](#)
- [NVIDIA Quadro FX 1400](#)
- [NVIDIA Quadro FX 1500](#)
- [NVIDIA Quadro FX 1700](#)
- [NVIDIA Quadro FX 1800](#)
- [NVIDIA Quadro FX 3400](#)
- [NVIDIA Quadro FX 3450](#)
- [NVIDIA Quadro FX 3500](#)
- [NVIDIA Quadro FX 3700](#)
- [NVIDIA Quadro FX 3800](#)
- [NVIDIA Quadro FX 4400](#)
- [NVIDIA Quadro FX 4500](#)
- [NVIDIA Quadro FX 4600](#)
- [NVIDIA Quadro FX 4800](#)
- [NVIDIA Quadro FX 5500](#)
- [NVIDIA Quadro FX 5600](#)
- [NVIDIA Quadro FX 5800](#)
- [NVIDIA Quadro K600](#)

NVIDIA Quadro 6000

Windows XP / Windows 7 (64bit)

Viz Artist/Engine Version	Driver
3.5.4	311.50
3.5.2 - 3.5.3	296.70
3.1.0 - 3.5.1	275.36

The card supports:

- SDI output with Matrox X.mio2.
- SDI capture with NVIDIA Quadro SDI Output card.
- G-SYNC II.

NVIDIA Quadro 5000

Windows XP / Windows 7 (64bit)

Viz Artist/Engine Version	Driver
3.5.4	311.50
3.5.2 - 3.5.3	296.70
3.1.0 - 3.5.1	275.36

The card supports:

- SDI output with Matrox X.mio2.
- SDI capture with NVIDIA Quadro SDI Output card.
- G-SYNC II.

NVIDIA Quadro 4000

Windows XP / Windows 7 (64bit)

Viz Artist/Engine Version	Driver
3.5.4	311.50
3.5.2 - 3.5.3	296.70
3.1.0 - 3.5.1	275.36

NVIDIA Quadro 2000

Windows XP / Windows 7 (64bit)

Viz Artist/Engine Version	Driver
3.5.4	311.50
3.5.2 - 3.5.3	296.70

Viz Artist/Engine Version	Driver
3.1.0 - 3.5.1	275.36

NVIDIA Quadro FX 1400

Windows XP

Viz Artist/Engine Version	Driver
3.5.2	296.70
3.1.0 - 3.5.1	275.36
3.0	81.67

NVIDIA Quadro FX 1500

Windows XP

Viz Artist/Engine Version	Driver
3.5.2	296.70
3.1.0 - 3.5.1	275.36
3.0	162.62

NVIDIA Quadro FX 1700

Windows XP

Viz Artist/Engine Version	Driver
3.5.4	311.50
3.5.2 - 3.5.3	296.70
3.1.0 - 3.5.1	275.36

Viz Artist/Engine Version	Driver
3.0	162.62

NVIDIA Quadro FX 1800

Windows XP

Viz Artist/Engine Version	Driver
3.5.4	311.50
3.5.2 - 3.5.3	296.70
3.1.0 - 3.5.1	275.36

NVIDIA Quadro FX 3400

Windows XP

Viz Artist/Engine Version	Driver
3.5.2	296.70
3.1.0 - 3.5.1	275.36
3.0	81.67

NVIDIA Quadro FX 3450

Windows XP

Viz Artist/Engine Version	Driver
3.5.2	296.70
3.1.0 - 3.5.1	275.36

NVIDIA Quadro FX 3500

Windows XP

Viz Artist/Engine Version	Driver
3.5.2	296.70
3.1.0 - 3.5.1	275.36
3.0	81.67

NVIDIA Quadro FX 3700

Windows XP

Viz Artist/Engine Version	Driver
3.5.4	311.50
3.5.2 - 3.5.3	296.70
3.1.0 - 3.5.1	275.36
3.0	162.62

NVIDIA Quadro FX 3800

Windows XP

Viz Artist/Engine Version	Driver
3.5.4	311.50
3.5.2 - 3.5.3	296.70
3.1.0 - 3.5.1	275.36

NVIDIA Quadro FX 4400

Windows XP

Viz Artist/Engine Version	Driver
3.5.2	296.70
3.1.0 - 3.5.1	275.36

NVIDIA Quadro FX 4500

Windows XP

Viz Artist/Engine Version	Driver
3.5.2 - 3.5.3	296.70
3.1.0 - 3.5.1	275.36
3.0	83.62

The card supports:

- SDI output with Matrox X.mio2.
- G-SYNC II.

NVIDIA Quadro FX 4600

Windows XP

Viz Artist/Engine Version	Driver
3.5.4	311.50
3.5.2 - 3.5.3	296.70
3.1.0 - 3.5.1	275.36
3.0	162.62

The card supports SDI output with Matrox X.mio2.

NVIDIA Quadro FX 4800

Windows XP

Viz Artist/Engine Version	Driver
3.5.4	311.50
3.5.2 - 3.5.3	296.70
3.1.0 - 3.5.1	275.36

The card supports:

- SDI output with Matrox X.mio2.
- G-SYNC II.

NVIDIA Quadro FX 5500

Windows XP

Viz Artist/Engine Version	Driver
3.5.2	296.70
3.1.0 - 3.5.1	275.36 (or 91.36 when used with Video Wall (SDI only))
3.0	162.62

The card supports:

- SDI output with Matrox X.mio2.
- G-SYNC II.

If you experience driver problems, set **use_old_nv sdk** to 1 in the Viz Config file.

NVIDIA Quadro FX 5600

Windows XP

Viz Artist/Engine Version	Driver
3.5.4	311.50
3.5.2 - 3.5.3	296.70
3.1.0 - 3.5.1	275.36
3.0	162.62

The card supports SDI output with Matrox X.mio2.

NVIDIA Quadro FX 5800

Windows XP

Viz Artist/Engine Version	Driver
3.5.4	311.50
3.5.2 - 3.5.3	296.70
3.1.0 - 3.5.1	275.36

The card supports:

- SDI output with Matrox X.mio2.
- G-SYNC II.

NVIDIA Quadro K600





Windows 7 (64bit) / Windows Server 2008 R2/SP1 (64bit)

Viz Artist/Engine Version	Driver
3.6.4	341.21

6 Starting Viz Engine

To start and run Viz Engine, you need to connect to an available Graphic Hub. Viz Engine can also be started with various options included (see [Viz Command Line Options](#)). To start Viz Engine with an option or options, the command for that option must be added before Viz Engine start-up.

6.1 To Start Viz Engine

1. Start Viz Engine.
2. In the Graphic Hub login window, provide the required details:
 - : Select a Host from the drop-down list. You can also type the host name, if the host does not appear in the list. This may happen if the server is on a different sub-net.
 - : Select a Graphic Hub from the drop-down list.
 - : Select a User from the drop-down list.
 - : Type the correct password for the selected User.
 - **Log me in automatically:** If auto log in is available, click to enable automatic log on. This makes Viz Engine automatically connect and log on to a pre-defined Graphic Hub on start-up.
3. Click **Log in**.

6.2 To Add A Viz Engine Startup Option

1. Right click the Viz Engine icon and select **Properties**.
2. In the **Shortcut** pane, apply a command in the **Target** field (see [Viz Command Line Options](#)).

 **Example:** "<viz install folder>\3.xx.x\viz.exe" -n

3. Click **OK**.
4. Start Viz Engine.

6.2.1 Viz Configuration

Viz Artist/Engine is mainly configured by the [Configuring Viz](#) application. All configuration settings are stored in the Viz Config file, found in the <viz data folder>. The Viz Config file uses the machine host name to uniquely identify which machine Viz Artist/Engine is installed on, as for example, *Viz-<hostname>-0-0.cfg*.

Any changes to the host name affect the Viz Artist/Engine. If a host name is changed, a new Viz Config file is created with a default setup. The old Viz Config file is not deleted, but left unused. If required, use the command `-g <configuration file>` (see [Viz Command Line Options](#)) to reassign the old Viz Config file.

 **IMPORTANT!** Viz Engine ignores text following a Hash tag. Do not use the Hash tag (#) in any folder, file or path name.

6.3 Viz Console

The Viz Console window is mainly used for debugging purposes, to display information about the running Engine or connected Graphic Hub, and for manually sending commands directly to the Engine. The Viz Console shows the commands that are used in communication between the Viz Engine renderer and other components, such as Viz Artist, External Control Applications, plug-ins, and scripts.

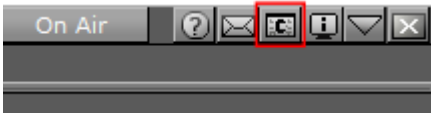

For an overview of the available commands, open the console window and type `?` or `help`, then press enter. This outputs a list of the available console commands. The complete documentation for the command interface is included with the Viz installation, and can be found under `<Viz Install Folder>\Documentation\CommandInterface`.

IMPORTANT! The Viz Console is case sensitive.

6.3.1 Issuing External Commands to Viz Engine via Console

External Control Applications, such as Viz Trio and Viz Pilot, communicate with Viz Engine through External Control commands. Viz Engine supports a wide range of such commands. Any installation of Viz Engine and Artist also come with the application **Viz Send**, which mimics the behavior of External Control Applications.

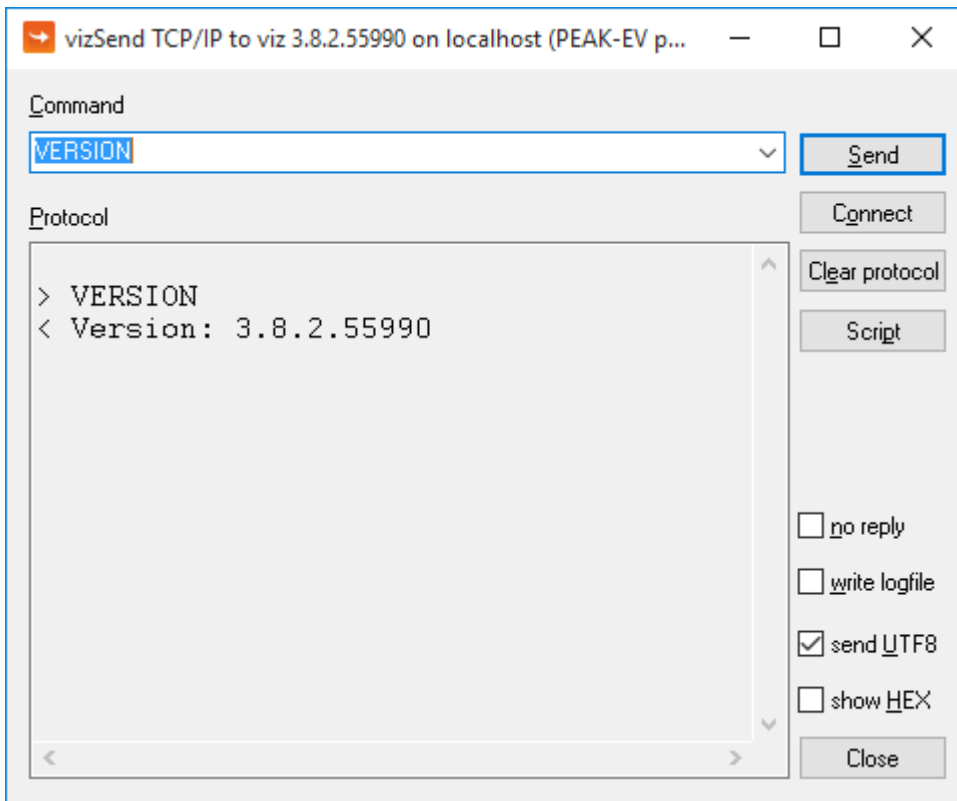

External Commands can also be sent manually to Viz Engine through the console window, using the `send` command. External commands range from loading a scene and taking the scene On Air, to shutting down Viz Engine. To issue a command to the Engine, open the console window and type `send [COMMAND]`, then press enter. For example, the command `VERSION` can be used to display the current Viz version and build number: `send VERSION CONSOLE: answer <Version: 3.8.2.55990>`

Most commands also have a subset of commands. All commands in the Engine follow a specific syntax, and can be passed either properties or further commands. The general syntax structure is: `[Leading flag] [Location] [Command] [Value]`

Locations and commands may also have sub-locations or subsets of commands, respectively, in which case an asterisk serves as the divider between each part. Please see the examples below for a better understanding of how to address these.

- **Leading Flag:** Define if Viz Engine should send a reply to the command being issued. A leading `-1` indicates that no reply is required. Positive integers, including `0`, serve as a command ID. This allows an external control application to match the reply to the corresponding command request, if several commands are sent simultaneously.
- **Location:** The location can be the main object, configuration, an object ID, one of the object pools, a container or geometry, a key-frame, a shared memory (SHM) location, a layer, and so on. In addition, the location can be any command or property of such. In essence, anything in Viz could serve as the location for a command. As an example, a scene can be loaded into any one of the three layers in Viz; **Back** layer, **Main** layer and **Front** layer. The layers can be addressed by name:
 - `RENDERER*MAIN_LAYER`
 - `RENDERER*FRONT_LAYER`

- `RENDERER*BACK_LAYER`
In addition, the scene can be accessed directly by referring to the scene via its database path, UUID, REST URL or temporary object ID:
- `SCENE*SceneLocation`
- **Command:** The Command part of the syntax can consist of either a property or another command.
- **Value:** The value for the command, which can be for example a numeric value, a location or a state.

✓ **Tip:** `COMMAND_INFO` is a very useful command, used to display help on any other command or subset. For example, passing the command `send RENDERER COMMAND_INFO` displays a list of all available properties and commands for the **RENDERER** command, while `RENDERER*BACKGROUND` displays properties and commands for the **BACKGROUND** sub-command of the **RENDERER** command.

Viz Engine can address locations in three ways, by either **UUID**, **Path** or **REST**:

- **UUID:** Universally Unique Identifiers are always provided angle brackets, for example `<1A85AC97-00AE-E74B-A236EDA262D69908>`.
- **Path:** The full path to the item, as seen in Viz Artist.
- **REST:** In addition to the built-in [Viz Engine REST interface](#), Viz Engine also interprets Graphic Hub REST URLs as part of commands. Even though the commands themselves are case sensitive, the host names and UUIDs in REST URLs are not. The URLs may also contain special characters, like a forward slash.

These are all valid as locations when passing commands to Viz Engine, although they change the appearance of the command itself. Here is an example command setting an image as background image for the loaded scene, for each location method:

- **UUID:** `RENDERER*BACKGROUND*IMAGE*IMAGE SET IMAGE*<1A85AC97-00AE-E74B-A236EDA262D69908>`
- **Path:** `RENDERER*BACKGROUND*IMAGE*IMAGE SET IMAGE*01_DOC_EXAMPLES/Images/Bear`
- **REST:** `RENDERER*BACKGROUND*IMAGE*IMAGE SET IMAGE*http://GH\SERVER:19398/image/1A85AC97\00AE\E74B\A236EDA262D69908/Bear`

✓ **Tip:** **Object IDs** are temporary shortcuts created on the fly when an item is loaded into memory, and removed when unloading the item or restarting Viz. To get an objects Object ID, pass the **GET** command to the **OBJECT_ID** location of the object. For example:
`MAIN_SCENE*OBJECT_ID GET.`



6.3.2 Internal Commands

For ease of use, internal commands can be set to be hidden or visible. Under certain circumstances, some plug-ins may need to send commands on every frame. This can leave the Viz Console window flooded with text, leaving it unreadable. By default, internal commands are hidden, meaning these messages do not output to the console window. To see all internal commands by default, the Viz configuration file must be manually edited, setting `show_internal_commands` to 1. During normal operation, however, it would usually suffice to temporarily activate the output of internal commands to the console, by clicking the  (Show

Commands) icon in the Viz Artist or Viz Engine GUI. This also makes the console window stay on top, meaning it is not hidden behind other full-screen applications, such as Viz Artist or an Engine in [On Air Mode](#).

6.4 Viz Command Line Options

You can start Viz Artist and Viz Engine with various startup options. These command line parameters must be passed to the Viz executable file, *viz.exe*, and not to the batch file, *viz.cmd*. The batch file is only there for compatibility reasons. The table below details the most common Viz Command Line Options. You can get a list of all available startup options, by running `viz.cmd -h` or `-?` from the command line.

Command	Description
<code>-B <path></code>	Specify the path where Viz Engine stores its temporary data (see Viz Artist and Engine Folders)
<code>-c</code>	Start in Viz Configuration mode (see also <code>-u1</code> , <code>-u2</code> , <code>-u3</code>)
<code>-C</code>	Start without a console.
<code>-db user:pw@server/name-server:port</code>	<p>Specify which Graphic Hub to connect to on Viz Engine startup. <code>password</code> can be omitted from the argument, but <code>user</code>, <code>server</code>, <code>name-server</code> and <code>port</code> must always be provided.</p> <div style="border: 1px solid #ccc; padding: 5px; margin: 5px 0;"> <p> Example: <code>viz.exe -db Guest:@VizDbServer/localhost:19396</code></p> </div> <p>In the example above, Viz Engine connects to a Graphic Hub server called <code>VizDbServer</code> ( case sensitive) on the name-server <code>localhost</code> at port <code>19396</code>, as the user <code>Guest</code> with no password.</p>
<code>-g <config file></code>	Start with a predefined Viz Config file. This allows a User to have more than one startup option
<code>-h, -?</code>	Display the available commands.
<code>-i</code>	Enable pre-initialization of textures. Textures are generated on the graphics card immediately after loading an image
<code>-l</code>	Specify a console title to distinguish Viz Engines in a Dual Channel setup (example: <code>-l <title></code>)

Command	Description
-n -o <scene> -o <layer> <scene>	Start in Viz Engine mode (see also -u1, -u2, -u3). There is also an optional argument may give a scene that is loaded upon startup with the following syntax: SCENE*scene_id ... load scene_id into the main layer 1 SCENE*scene_id ... load scene_id into the main layer 0 SCENE*scene_id ... load scene_id into the back layer 2 SCENE*scene_id ... load scene_id into the front layer
-P	Disable automatic mouse capture.
-t	Enables non-interactive mode for all occurrences except dongle issues and sound driver setup. The non interactive mode was introduced for use cases where there is no user and when there is no GUI one can interact with.
-T	Keep the Viz Engine Console always on top
-u1, -u2, -u3 (up to a maximum of 24)	For systems with two or more graphic cards (i.e. Trio One Box / Dual Channel). Specify GPU1 (-u1), GPU2 (-u2), etc., to run Viz Artist on. See Systems with Two or More GPUs below.
-v [argument]	Enable verbose mode. This enables all possible information to be shown in the Viz Engine Console. The optional argument is a number composed by addition of 1 : produce verbose output to console 2 : add a timestamp 4 : log OpenGL 16 : log 2d-texture messages 32 : log Graphic Hub related debug messages 64 : log medium and high GL warnings
-w	Start in Engine mode and show render windows (videowall mode).
-W	Disable restart on crash.
-x	Start without any GUI
-X	Write extended dump file (full memory dump) in case of a program crash.
-y	Start in Artist mode. Viz Artist is started by Viz Engine after the Engine has started.

Command	Description
-Y <path>	Specify the path where Viz Engine stores its program data (see Viz Artist and Engine Folders)

6.4.1 Systems with Two or More GPUs

It is possible to specify which GPU Viz Engine should run on, by providing the flags `-u1` and `-u2` for GPU1 and GPU2, respectively. A maximum of four GPUs are supported. This allows the system to run the Engine on one GPU while running Viz Config on another, for example:

```
<viz install folder>\viz.exe -c -u2
<viz install folder>\viz.exe -n -u1
```

More than one Viz Engine can run on one GPU (multiple Viz Engines can not run on the GPU with the same port number), use the formula `m%n` to calculate which Viz Engine instance to use (Viz Engine defined by `-u<m>`). Note, however, that Viz Artist can only run on Viz Engine instance 1 (`-u1`). Only the control GPU should have a display connected and is used for Artist/Preview.

Formula: `m%n`, where:

- `m` = `-u1/-u2/etc.`
- `n` = number of GPUs

For example, with two Viz Engines:

- System with two GPUs: Engines run on GPU2: Engine 1 (`-u2`) / Engine 2 (`-u4`)
- System with three GPUs: Engines run on GPU2: Engine 1 (`-u2`) / Engine 2 (`-u5`)

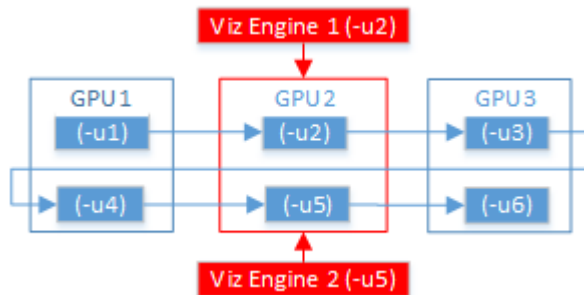

When either Trio One Box or Dual Channel Viz Artist versions are installed, GPUs are selected by default.

7 Configuring Viz

Viz Configuration is the configuration interface for Viz Engine and other applications that integrate with Viz Engine.

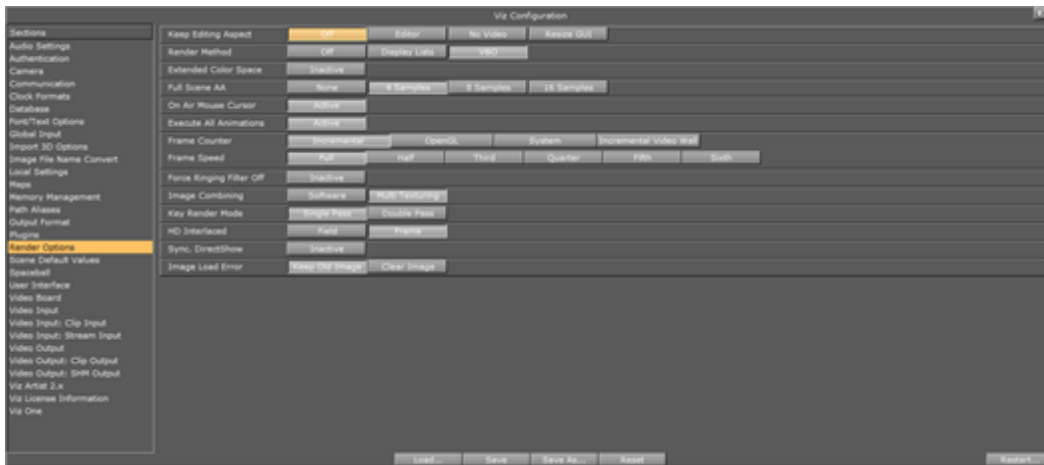

The Viz Configuration user interface is divided in two parts:

- **Sections:** Shows a list of all the sections available for configuration.
- **Configuration Parameters:** Shows all available configuration parameters for each section.

Various parameters regarding the program functionality can be set in the configuration. Viz Artist/Engine is mainly configured with the Viz Configuration. All configuration settings are stored in a Viz Config file (located in the *<viz data folder>*). The Config file uniquely identifies the machine that Viz Artist/Engine is installed on by its host name, for example *Viz-<hostname>-0-0.cfg*. Any changes to the host name affects the configuration. If a host name is changed, a new Viz Config file is created with a *default* setup. The old Viz Config file is not deleted but left unused. If required, the old Viz Config file can be reassigned with the command `-g <configuration file>`.

Caution: Make sure that any changes are saved before Viz Configuration is closed. Changes are not saved and do not take effect until Viz Artist has been closed and started again.

7.1 Working With Viz Configuration

To configure Viz Artist and Engine, click the **Config** button in Viz Artist or start the Viz Configuration application from the Start menu. Viz Artist/Engine also has a selection of Installed Configuration Profiles. When the configuration profiles are saved, only the settings that differ from the default configuration of a setup (VGA mode, Video mode, etc.) is saved.

Viz Configuration adjusts its size to the current screen resolution when it opens. When running Viz Configuration without Viz Artist, it checks the resolution and limits the size to 1430 x 750 pixels. This is useful for high-resolution configurations, especially during [Video Wall Configuration](#).

7.1.1 To Start Viz Configuration

- Run Viz Configuration from the desktop shortcut or the **Start** menu.

- If Viz Artist is running, click **Config** or press **F11**.

7.2 Modify Viz Configuration

This section details how to Save, Save as..., Reset and Load Viz Configurations.

7.2.1 To Save the Current Configuration

1. Start Viz Configuration.
2. Change the configuration as required.
3. Click **Save**.

 **IMPORTANT!** Changes made to the resolution can affect an in use IP streaming service. Make sure to check the IP streaming service configuration.

4. Click the **Restart** button to apply the saved changes. The Viz Config file is updated.

7.2.2 To Reset the Viz Config File

The **Reset** button sets the configuration to default settings.

1. Start Viz Configuration.
2. Click **Reset**.
3. Click **Restart** to apply the changes.

7.2.3 To Restart Viz Configuration

Click the **Restart** button to save changes.

1. Click **Restart**.
2. Select from:
 - Current
 - Viz Engine w/GUI
 - Viz Engine w/o GUI
 - Viz Artist
 - Viz Config

7.3 Installed Configuration Profiles

Viz Artist/Engine is installed with a selection of Configuration Profiles. These profiles are a set of predetermined basic settings to run Viz Artist/Engine for specific purposes, for example, [Dual Channel Mode](#), [Trio Box CG Mode](#) or a [Video Wall Configuration](#).

Once loaded into the Viz Configuration, these files can be modified to refine the profile to specific needs, which can then be saved. Pre-installed Configuration Profiles are located in: *<viz install folder>\Configuration Profiles*.

7.3.1 To Load a Pre-Installed Configuration Profile

1. Start Viz Configuration.
2. Click **Load** and select **Installed Profile**. The correct folder opens automatically.
3. Open the required Configuration Profile.
4. Click **Restart** to load the Configuration Profile.

7.3.2 To Save a Custom Profile

A Configuration Profile cannot be saved to the <viz install folder>. A UAC requirement is that an application must not write to the installation folder (see [User Account Control](#)). The default location for custom Configuration Profiles is %Programdata%\Vizrt\Viz3.

1. Start Viz Configuration.
2. Change the configuration as required.
3. Click **Save As**.
4. Select a location to save the new Configuration Profile. The default location is %Programdata%\vizrt\Viz3.
5. Type a name for the new Configuration Profile.
6. Click **OK**.

7.3.3 To Load a Custom Configuration Profile

1. Start Viz Configuration.
2. Click **Load** and select **Custom Profile**. The correct folder opens automatically.
3. Locate a saved Configuration Profile (*.cfg).
4. Open the required Configuration Profile.
5. Click **Restart** to load the saved Configuration Profile.

7.4 Audio Settings

This section provides information about the following:

- [Various Tab](#)
- [Channels Tab](#)
- [Manual Audio Configuration](#)

7.4.1 Various Tab

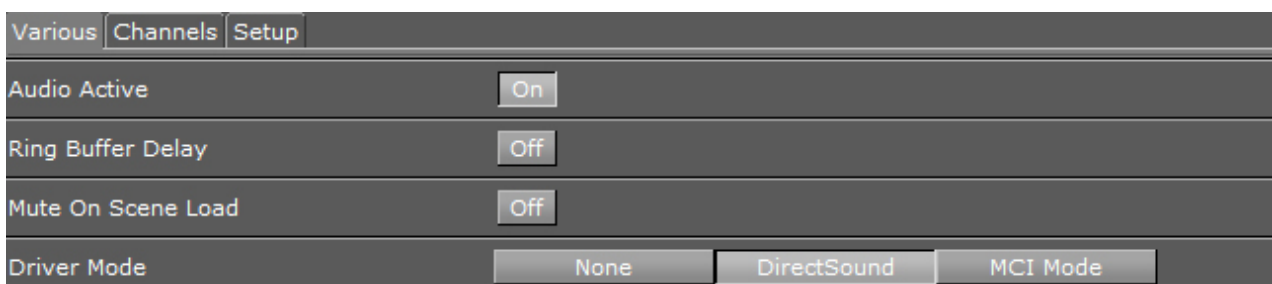

- **Audio Active:** Toggles audio in Viz Engine on/off.
- **Ring Buffer Delay:** Makes the audio system compensate for the ringbuffer delay during clip playout. Ringbuffer is ignored when disabled.
- **Mute On Scene Load:** Mutes audio before any scene load commands are executed when set to on. This is necessary for video cards which do not mute the audio automatically, or when no video refresh happens.

Note: Additional commands to mute audio can be added in the Viz Config file.

- **Driver Mode:** Affects playback of sound on the computer running Viz Engine, for audio monitoring purposes.
 - **None:** Prohibits Viz Engine from playing out sound on the local system.
 - **DirectSound:** Uses DirectSound drivers (requires DirectX). This is the recommended driver.
 - **MCI Mode:** Uses MCI driver mode, for systems where DirectSound is either not available or performs unsatisfactorily.

7.4.2 Channels Tab

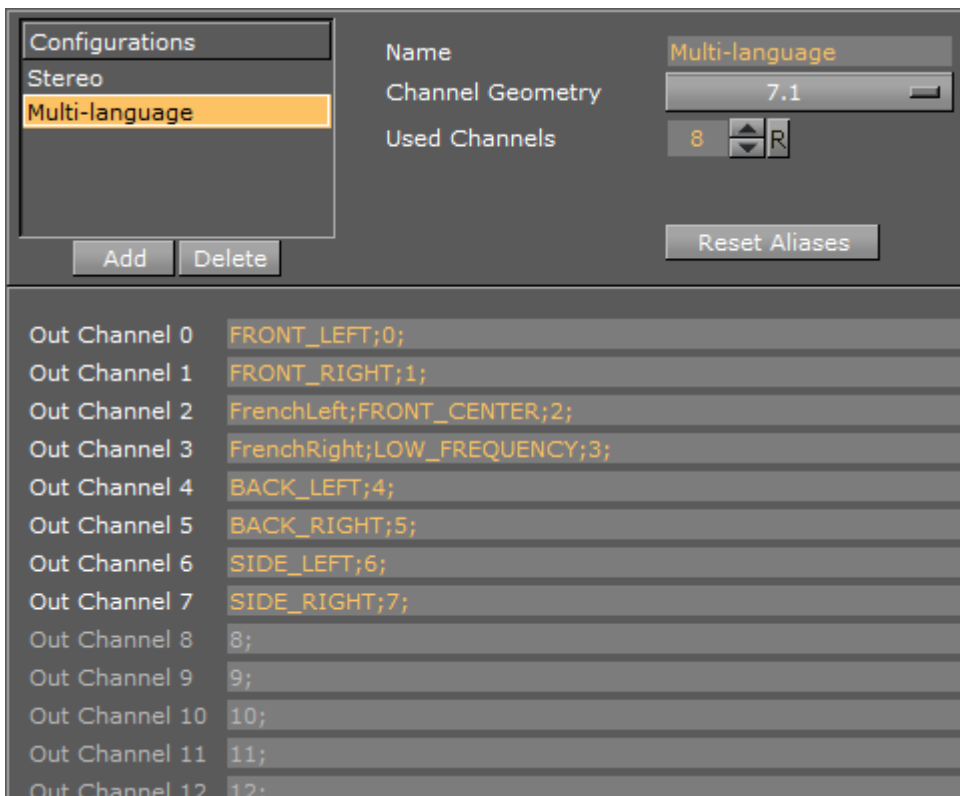

- **Configurations:** Shows a list of channel configurations.
- **Add:** Adds a new channel configuration to the Configurations list.
- **Delete:** Deletes the selected channel configuration from the Configurations list.
- **Name:** Sets the name of the selected channel configuration.
- **Channel Geometry:** Sets the channel geometry. Options are:

- Mono
 - Stereo
 - 5.1
 - 7.1
 - Quad
- **Used Channels:** Sets the number of configurable channel alias fields that can be mixed by the internal channels in Viz Engine (software). On a Matrox system this number must be equal to the number of configured input channels (hardware). This setting is independent of the Channel Geometry setting.
 - **Reset Aliases:** Sets the channel aliases to the default option (the custom entry is not removed).
 - **Out Channel 0-15:** The Out Channels represent the internal Viz audio channels, which are mixed to the output device one by one. Alias names are useful to create multilingual systems, and also to define the channel geometry for the Default and FX audio clip mix modes. Aliases are separated by a semicolon. The **Audio** plug-in only uses the channel aliases to find the correct speakers for Pan and 3D sound effects in FX mode. With this functionality any of the 16 internal audio channels can be used to play any audio geometry.

To Add Multi-language Audio Channels

1. From the Channels tab, click **Add**.
2. Select the new entry from the **Configurations** list
3. Enter the new name in the **Name** field.
4. Set the Channel Geometry to **Stereo**.
5. Click **Reset Aliases**.
6. Set the number of **Used Channels** to 4. This improves the performance.
7. In the **Channel 2** field, add the alias **FrenchLeft**.
8. In the **Channel 3** field, add the alias **FrenchRight**. Add the same configuration for English (EnglishLeft, EnglishRight) and German (GermanLeft, GermanRight) on the other machines.
9. Click **Save**.

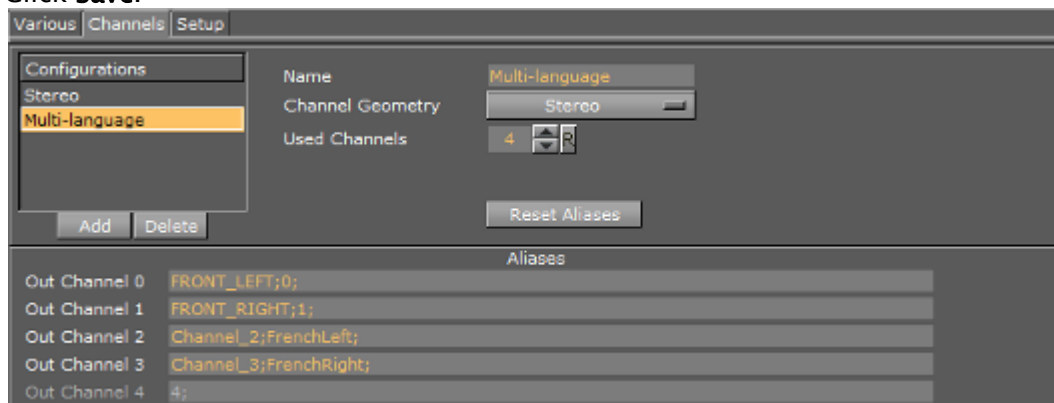

To Add Multiple Audio Channel Configurations

1. Repeat [To Add Multi-language Audio Channels](#) to add three more Multi-language Audio Channels.
Name the configurations the following way:

- **Multi-languageF**
 - **Multi-languageE**
 - **Multi-languageG**
2. Add a **Multi-languageAll** configuration.
 3. In the **Channel 1** field, add the aliases **FrenchLeft**, **EnglishLeft** and **GermanLeft**.

```
FRONT_LEFT;
Channel_0;FrenchLeft;EnglishLeft;GermanLeft;
FRONT_RIGHT;
Channel_0;FrenchRight;EnglishRight;GermanRight;
```

4. In the **Channel 2** field, add the aliases **FrenchRight**, **EnglishRight** and **GermanRight**.
5. Click **Save**.

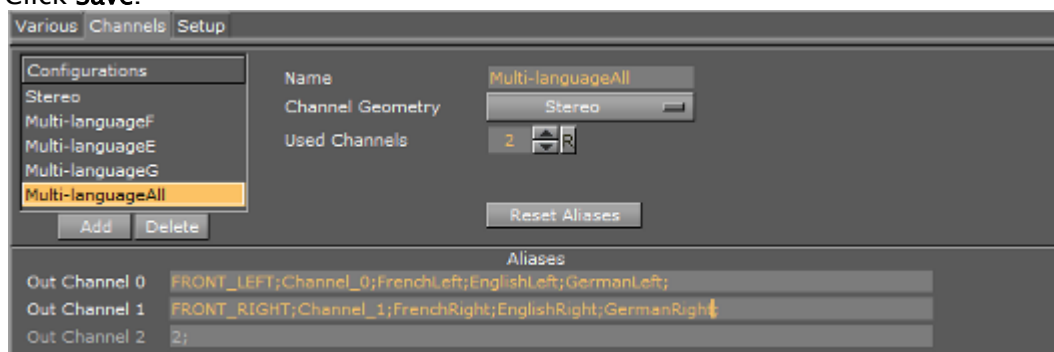

Setup Tab

The Setup tab lists all available audio devices available to the Viz Engine audio mixer (see [Audio in Viz](#)). All devices listed with **Device0** are DirectSound compatible devices installed on the system. **Device0** is always the default playback device, configurable through **Sound** options in the Windows system **Control Panel**.

When a Matrox card is installed, Matrox audio is available. With Matrox audio, there are different ways to capture audio for use with the Viz Engine audio mixer, before it is output:

1. Capture audio embedded in the live video input signal from the live input connectors.
2. Capture audio from the AES connectors.

The final output is the same, either embedded as part of the live video output signal, or separated out to the AES output connectors. In addition, simply loop audio through the system. This makes the embedded or AES audio unavailable to the Viz Engine audio mixer.

The **Default** mode captures audio and directs it to the default onboard audio device with no output on the Matrox card output connectors.

Note: The Matrox audio-extension board is not configurable through this user interface.

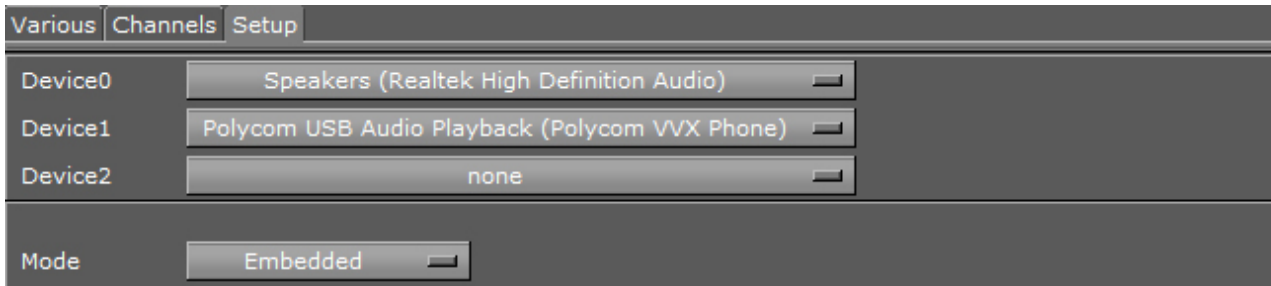

- **Device *n*** : Shows the name of the audio card.
- **Mode**: Refers to the audio mode of the Matrox board. Options are:
 - **Embedded**: Captures audio from the Live video input connectors and is made available to the Viz Engine audio mixer, to mix it with other audio sources. Then output as embedded audio on the live video output connectors.
 - **AES**: Captures audio from the AES input connectors and is made available to the Viz Engine audio mixer, to mix it with other audio sources. Then output on the AES output connectors.
 - **Embedded -> AES**: Captures embedded audio from the live video input connectors and is made available to the Viz Engine audio mixer, to mix it with other audio sources. Then output on the AES output connectors.
 - **AES -> Embedded**: Captures audio from the AES input connectors and is made available to the Viz Engine audio mixer, to mix it with other audio sources. Then output as embedded audio on the live video output connectors.
 - **Loop**: Loops audio through. No audio is mixed.
 - **Default**: Captures audio, but no output on the Matrox card.

7.4.3 Manual Audio Configuration

Certain use-cases require manual configuration of audio. Make sure to create a backup of the Viz configuration file before performing the following procedures:

To Map Audio Output for a Dual Channel Setup

1. In a Dual Channel environment there are two Config files, one for each Viz Engine.
2. For the first Viz Engine (1) the configuration of the audio output channel mappings should look like this:

```
Matrox0.AudioOut1.MapToVizChannel = 0
Matrox0.AudioOut2.MapToVizChannel = -1
```

3. Note that the audio output for the first Viz Engine (1) should be according to the video output channel:

```
Matrox0.VideoOut1.MapToVizChannel = 0
Matrox0.VideoOut2.MapToVizChannel = -1
```

- For the second Viz Engine (2) the configuration should look like this:

```
Matrox0.AudioOut1.MapToVizChannel = -1
Matrox0.AudioOut2.MapToVizChannel = 0
```

Note: In a stereo setup, audio must be set to off in the second Viz Engine (2).

- Mind the difference to the video output settings:

```
Matrox0.VideoOut1.MapToVizChannel = -1
Matrox0.VideoOut2.MapToVizChannel = 0
```

- All other audio output channels should be set to off:

```
Matrox0.AudioOut3.MapToVizChannel = -1
Matrox0.AudioOut4.MapToVizChannel = -1
```

To Manually Activate an Audio Device

- Open the Viz Config file.
- Go to **SECTION AUDIO_CONFIG** and locate the **Available0** setting.
- Activate the identified audio device (**Available0**) by adding its name to the **AudioDevice0** setting. For multiple outputs, more than one device can be added as **AudioDevice1**, **AudioDevice2** and so on.
- Save the Viz Config file.

Example: AudioDevice0 = Realtek HD Audio output

7.5 Authentication

The Authentication panel is for the authentication of one or more **Viz One** systems on Viz Artist. Enter the details of each Viz One system to connect to. To save a new user, all three panels of the Authentication panel must be completed. If a Realm is not required, enter <empty> in the Realm panel. If only one or two panels are completed, the information is not saved.

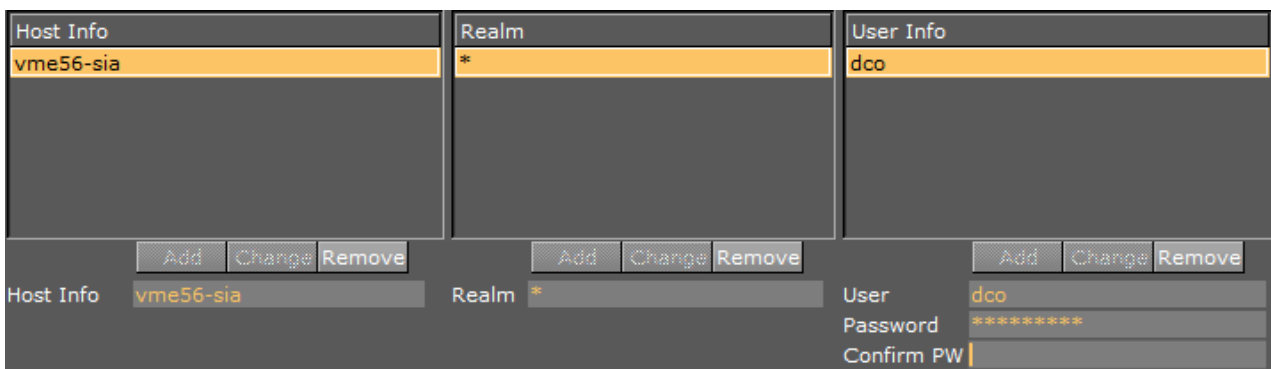

- **Host Info:** The host name of the Viz One server.
- **Realm:** Determines if an entry should be used in an authentication process for a given URI.
- **User Info:** Name and password for each User, for the selected Host and Realm.

7.5.1 Authentication Properties

Host Info Properties

The host name of the Viz One server (see also [Fsmon \(File System Monitor\)](#)). The host info is in the form 'host:port', where the colon and port number are optional. An asterisk value, '*', shows that it is used against all hosts. The host info can be the Viz One host name or IP address.

Examples:

- Host Info = myhost.mycompany.com:8080
- Host Info = 10.0.1.2:8080
- Host Info = *

- A Host cannot be added without at least one Realm (or an empty Realm with *<empty>* entered) and one User defined.
- A Host can have more than one Realm.

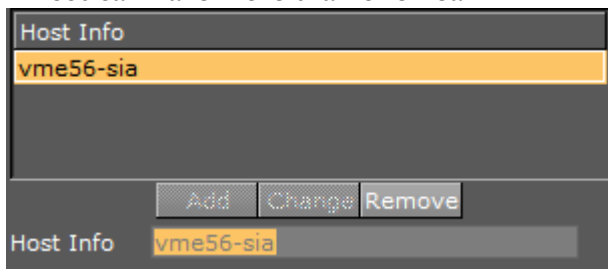

- **Add:** Adds a host name.
- **Change:** Changes a selected host name.
- **Remove:** Removes a selected host name.
- **Host Info:** Displays the name of the required Viz One host.

 **Note:** Do not enter a URL as the Host Info name. The Host Info name format must be host[:port], for example: *vizone.mycompany.com:8080*.

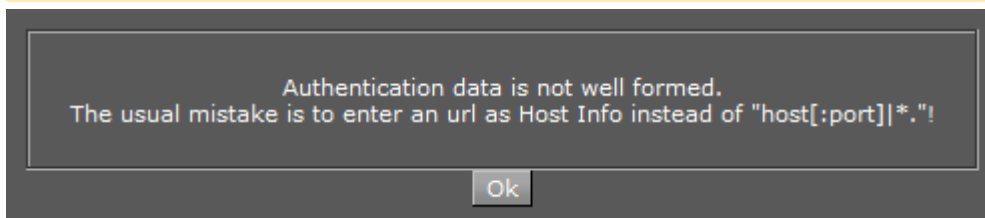

Realm Properties

Determines if an entry should be used in an authentication process for a given URI.

Example: A single value of shows that it should be used against all realms (i.e. Realm = [a-zA-Z_0-9] or ' * ').

- A Realm cannot be added to a Host without at least one User defined
- A Realm can have more than one User.

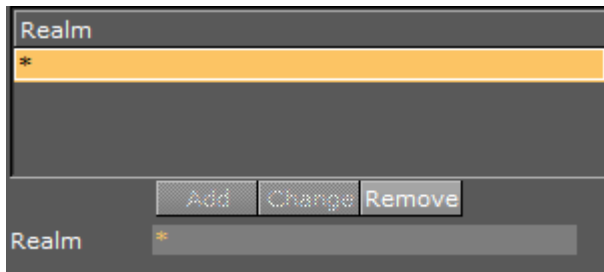

- **Add:** Adds a Realm.
- **Change:** Changes a selected Realm.
- **Remove:** Removes a selected Realm.
- **Realm:** Displays the name of the required Realm.

User Info Properties

Name and password for each user, for the selected Host and Realm. Passwords are not mandatory.

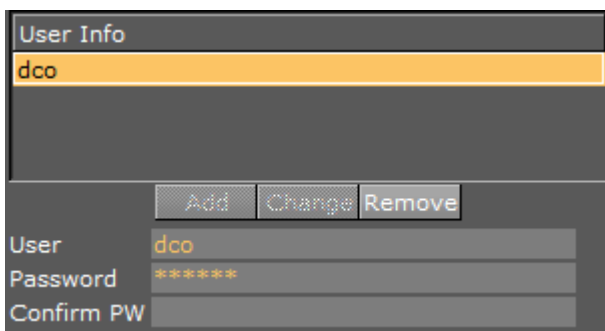

- **Add:** Adds a user.
- **Change:** Changes a selected user.
- **Remove:** Removes a selected user.
- **User:** Enter the user name.
- **Password:** Enter a password for the user, if required.
- **Confirm PW:** Confirm the user password.

7.5.2 Authentication Panel Procedures

Do not enter a URL as the **Host Info** name. The Host Info name format must be `host[:port]`. For example: `www.mycompany.com:8080`. Only entries which consist of Host + Realm + User are saved to the configuration file. After the completion of the required procedures, make sure that you restart Viz Artist. Changes are not saved until Viz Artist has been restarted.

To Add a Viz One Host

To add a Viz One Host, a Realm and a User must also be defined.

1. Enter a Viz One Host name.
2. Click **Add**.

Host Info: Host1

Buttons: Add, Change, Remove

3. Enter a Realm name. If no Realm is required, enter <empty>.
4. Click **Add**.

Realm: Realm1

Buttons: Add, Change, Remove

5. Enter the new User name.
6. Enter and confirm the password, as required.
7. Click **Add**.

User: User1

Password: ***

Confirm PW: ***

Buttons: Add, Change, Remove

8. Click **Save** or **Save as...**

Host Info	Realm	User Info
Host1	Realm1	User1

To Add a Realm

1. Click on a Viz One Host.
2. Enter a Realm name.
3. Click **Add**.

Realm: Realm2

Buttons: Add, Change, Remove

4. Enter a User name.
5. Enter and confirm the password, if required.
6. Click **Add**.

User: User2

Password: ***

Confirm PW:

Buttons: Add, Change, Remove

7. Click **Save** or **Save as...**

Host Info	Realm	User Info
Host1	Realm1	User2
Host2	Realm2	
Host3		

To Add a User

1. Select a Viz One Host.
2. Select a Realm.
3. Enter a User name.
4. Enter and confirm a User password, if required.
5. Click **Add**.
6. Click **Save** or **Save as...**

⚠ Note: The password of the currently highlighted User always shows in the **Password** box.

To Change a Host, Realm or User Name

1. Click in the name field for either the:
 - Host Info
 - Realm
 - User
- Make a change to the name as required.
- Click **Change**.
- Click **Save** or **Save as...**

To Delete a Host, Realm or User Name

If a Host is removed, any defined Realms or Users for that Host are also removed. If a Realm is removed, all Users for that Realm are also removed. When the last User is deleted then the related realm is deleted as well.

1. Make sure that the item to be deleted is highlighted (1).
2. Click **Remove** (2) for either the:
 - Host Info
 - Realm
 - User
- Click **Change**.

- Click **Save** or **Save as...**

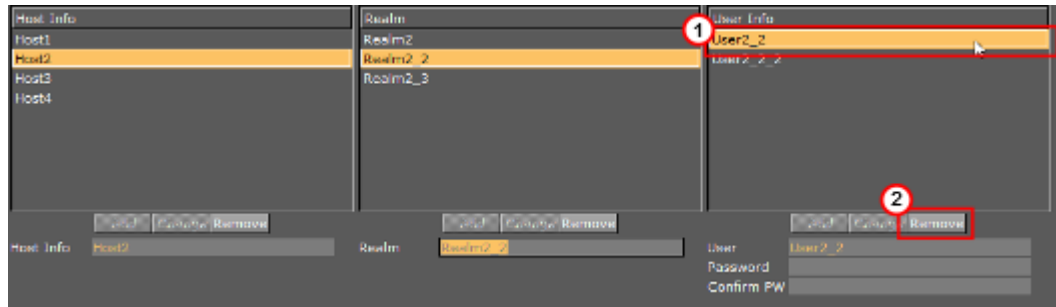

See Also

- [Viz One Configuration panel](#)

7.6 Camera

In the Camera section, special camera behavior settings which are used for virtual studio setups, can be set. Viz IO is used as the studio configuration and calibration tool for enabling connectivity and control between all required studio devices such as cameras, routers, VTRs, video servers, audio mixers and other studio equipment.

Note: Viz Tracking Hub and Studio Manager are the successors of VizIO. VizIO will be deprecated soon, please consider of upgrading your virtual studio installation to Tracking Hub. To enable Tracking Hub, set the flag *use_trackinghub* to 1, section CAMERA.

7.6.1 Camera Properties

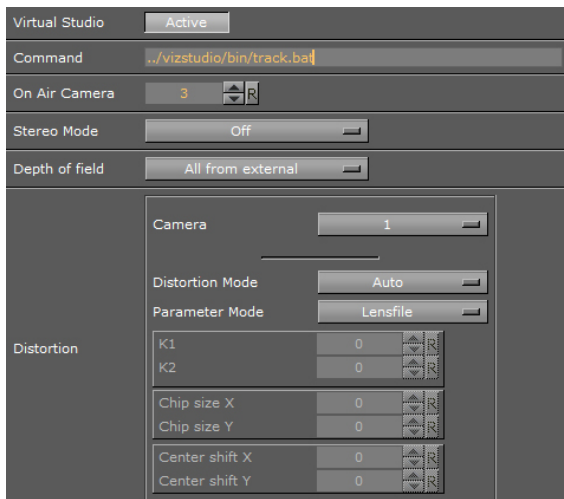

- Virtual Studio:** Starts the tracking process when Viz Engine is started when set to Active.
- Command:** Set the path to the batch file that starts the tracking process. If a valid path is given, Viz Engine starts Viz IO during startup.
- On Air Camera:** Activates the selected camera that should be used when setting the scene in **On Air** mode. The camera is controlled by an external tracking device.

- **Stereo Mode:** (license required):

⚠ Note: Stereo Mode settings only take effect when the design is taken On Air.

- **Off:** Makes Stereo mode unavailable and invisible in the GUI **Camera Editor**.
- **Quad Buffered:** Alternates the image for the left/right eye and darkens the other eye when using nVision glasses together with a monitor with a frequency >100Hz. This configuration provides the full resolution.
- **Over Under Left Top/Over Under Right Top:** Draws both images beneath each. Either side can be drawn first. The image height is halved, providing half resolution.
- **Left Eye/Right Eye:** Renders either the left or right eye image for dual-channel setups in combination with a Video Wall / Stereo Distributor. Full resolution.
- **Side By Side Left/Side By Side Right:** Renders both images side by side, either left or right first. The image width is halved, providing half resolution.
- **Depth of field:** Defines from where parameters are taken:
 - **Use editor:** Gets parameters for depth of field from the editor.
 - **Focal plane from external:** Gets only the focal plane from the external camera.
 - **All from external:** Gets all parameters from the external camera.
- **Distortion:** Here you can set the lens distortion parameters for each camera individually.
 - **Camera:** Sets the camera number.
 - **Distortion mode:** Sets the preferred distortion depending on the tracking system which is used. Available distortion modes are:
 - **Auto**
 - **Internal**
 - **Libero**
 - **Xpecto**
 - **Radial**
 - **Stype**
 - **Trackmen**
 - **Parameter mode:** set the parameter for the lens distortion, depending on the tracking system which is used:
 - **Auto**
 - **Lens File**
 - **Libero**
 - **Manual**
 - **Tracking Hub**

See Also

- **Advanced Lens Distortion** in the [Viz Artist User Guide](#).

7.7 Communication

In this section, network connections can be set. External control software, for example, Viz Trio, uses TCP/IP network connections to send commands to the Viz Engine renderer engine (some external communications are also through UDP). Viz Artist expects the commands at the ports

which are defined here. The Communication panel has three tabs, Global, Shared Memory and VDCP (Video Disk Control Protocol).

7.7.1 Global Properties

Global	Shared Memory	VDCP
General Comm. Port	6100	
Additional Communication	None Udp Udp&Multicast	
Udp&Multicast Port Number	6100	
Multicast IP Address	224.1.1.1	
Enable GPI	Inactive	
MUX Isolated Port	50007	
MUX Shared Port	50008	
MUX Fixed Port	50009	
Still Preview Port	50010	
Multi Touch Input	Server UDP Mouse Win7 Touch TUIO Leap Win Stylus	
Multi Touch Port	0	
Multi Touch IP Address		
TUIO Port	3333	
Display Diagonal (inches)	27.0	
Display Aspect Ratio	1.778	
Frame Accurate Viz Comm.	Off	
FAVC Bias	0	
Command Field Dominance	Always Odd Retrace Counter Even Retrace Counter	
	Intern. Always / Extern. Odd Intern. Always / Extern. Even	
On Air Mouse Events	On	
REST Webservice	0 Install Uninstall	
Enable Logging	Inactive	
GFX Port	0	

- **General Comm. Port:** Sets the general communication port for receiving external commands when in **On Air Mode**. Make sure to update settings on the client side if you change the default port. The default is port 6100 (TCP).
- **Additional Communication:** Enables sending of commands to Viz Engine on **UDP** and **Multicast**, or a combination of the two. Video Wall setups use this.
- **Udp&Multicast Port Number:** Sets the port number for the computers that share the same virtual IP address.
- **Multicast IP Address:** Sets the shared virtual IP address.

Note: The default maximum number of TCP connections is limited to 255. Within this number of connections, a user defined limit of maximum connections can be set.

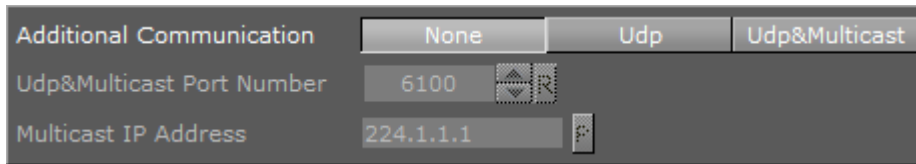

- **Enable GPI:** Enables initialization of supported Sealevel GPI/O devices when Viz Engine starts.
- **MUX Isolated Port:** Sets the port number for isolated sessions - no shared data (NLE).
- **MUX Shared Port:** Sets the port number for shared sessions - shared data (NLE).
- **MUX Fixed Port:** Sets the port number for fixed sessions - shared data, no reference counting (NLE).
- **Still Preview Port:** Sets the port number for still preview.
- **Multi Touch Input:**
 - **Server UDP:** Multi Touch events are retrieved from the Viz Multi Touch Interface (see protocol documentation, Viz MultiTouchServer). An external server application connects to the touch device, translates the hardware messages into the Viz Multi Touch Protocol, and sends it via UDP to Viz Artist or Engine. This triggers the internal Multi Touch events in scripts utilizing the plug-in API.
 - **Mouse:** Enable this to use a standard mouse to test Multi Touch trigger callbacks.
 - **Win7 Touch:** Viz Artist and Engine uses Win7 Touch messages to generate Multi Touch events.
 - **TUIO:** (Tangible User Interface Object) Select this if the touch device and/or application works with TUIO/OSC (Open Sound Control).
 - **Leap:** Leap Motion is a hand and finger-tracking device. Activate this to receive multi-touch events from Leap.
 - **Win Stylus:** Activates stylus pen input.
- **Multi Touch Port:** Sets the port number where Viz Engine listens for the multi touch server. Required for Server UPD communication.
- **Multi Touch IP Address:** Sets the IP address where Viz Engine listens for the multi touch server. Viz Artist and Engine sends keep-alive messages to the Multi Touch Server. You need to enter the IP address of this server. Required for Server UPD communication.
- **TUIO Port:** Sets the TUIO (Tangible User Interface Object) port number to communicate with a TUIO enabled multi-touch device. TUIO is a protocol for Table-Top Tangible User Interfaces. The default port for most TUIO applications is 3333.
- **Display Diagonal (inches):** Viz Artist and Engine can calculate transformations with momentum. For this, it needs to know the real, physical, screen-dimension to calculate the correct animation speeds. The value is in inches. Used for gesture recognition.
- **Display Aspect Ratio:** The real aspect ratio of the screen is required, as some screens do not have pixel aspect ratios of 1.0. Used for gesture recognition.

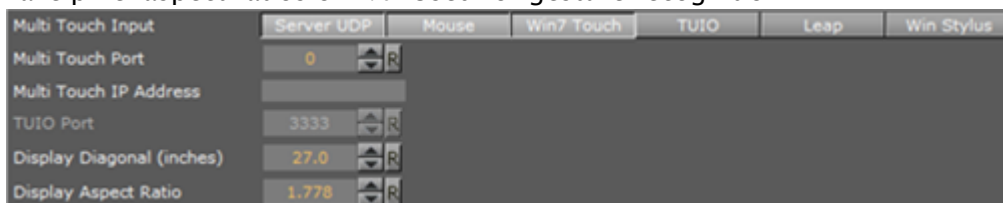

- **Frame Accurate Viz Comm.:** Frame accurate commands through TCP (commands delayed by ringbuffer and specified FAVC bias). Enable only for external control that supports special frame accurate command execution. Used with [Frame Accurate Output](#).
- **FAVC Bias:** Defines delay in fields, in addition to ringbuffer size, for frame accurate commands via TCP or GPI. This is the bias in frames for the commands, if **Frame Accurate Viz Comm.** is set to On. Allows negative values.

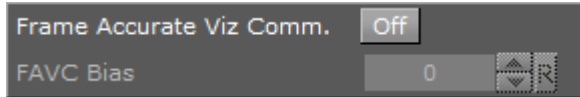

- **Command Field Dominance:** States when to handle the commands sent to Viz Engine. For example, when set to Odd Retrace Counter, Viz Engine handles all commands on odd fields. Not valid in progressive video output modes. Options are:
 - **Always.**
 - **Odd Retrace Counter:** Executes commands at an odd retrace counter.
 - **Even Retrace Counter:** Executes commands at an even retrace counter.
 - **Intern. Always/Extern. Odd:** Executes commands internally always and externally at an odd retrace counter.
 - **Intern. Always/Extern. Even:** Executes commands internally always and externally at an even retrace counter.
- **On air Mouse Events:** Sets mouse events in [On Air Mode](#) to On or Off.
- **REST Webservice:** Sets the port number for communication with the [Viz Engine REST interface](#). The default is 0, which deactivates the Webservice.

⚠ Note: To view the current documentation for the REST interface, go to <http://localhost:<port number>/#/documentation>

- **Install:** Sets the port number and click **Install** to install the Webservice.
- **Uninstall:** Removes the Webservice.

❗ IMPORTANT! The Webservice does not automatically install when [User Account Control](#) is active. Click **Install** to activate the Webservice.

- **Enable Logging:** Enables Webservice logging to the Viz Console.



- **GFX Port:** Sets the GFX Channel starting port number (GFX2: GFX Port+1, GFX3: GFX Port+2). For example: 55000, 55001, 55002, etc.

7.7.2 Shared Memory Properties

Global	Shared Memory	VDCP
Multicast IP Address	224.2.2.2	
Multicast Port	0	
UDP Port	0	
TCP Port	0	
Debug	Inactive	
Master Engine IP Address		
Master Engine Port	0	
Master Poll	Inactive Commands UDP TCP	

- **Multicast IP Address:** Sets the address for synchronizing distributed shared memory map without a Graphic Hub.
- **Multicast Port:** Synchronizes shared memory between all Viz Engines listening to the multicast.
- **UDP Port:** Sets the UDP listening port for the shared memory input.
- **TCP Port:** Sets the TCP listening port for the shared memory input.
- **Debug:** Enables Shared Memory logging for UDP and TCP communication.
- **Master Engine IP Address:** Sets the IP address of the master Viz Engine which holds the complete shared memory map (loaded during startup of Viz Engine).
- **Master Engine Port:** Sets the initializing port for the shared memory on startup (the command port of the master Viz Engine).
- **Master Poll:** Makes a Viz Engine load the shared memory map from the master Viz Engine, through the selected communication protocol. Available options are:
 - Inactive
 - Commands
 - UDP
 - TCP

To Limit the Number of TCP Connections

Since Viz Engine 3.3, the number of TCP connections to Viz Artist can be set in the Viz configuration. The maximum number of TCP connections is limited to 255. If set to 1, the first control application connecting to Viz Artist/Engine gets exclusive control over Viz Artist/Engine.

1. Open the Viz Config file (for example: *Viz-<hostname>-0-0.cfg*).
2. Under **SECTION COMMUNICATION** set 'max_tcp_connections' to the number of TCP connections required.

This setting applies to the default port (6100) and the Multiplexing Ports.

7.7.3 VDCP Properties

The VDCP (Video Disk Control Protocol) tab enables the configuration of up to eight external controllers which can then have basic control over clip-channels and render-layers (Front, Main, Back).

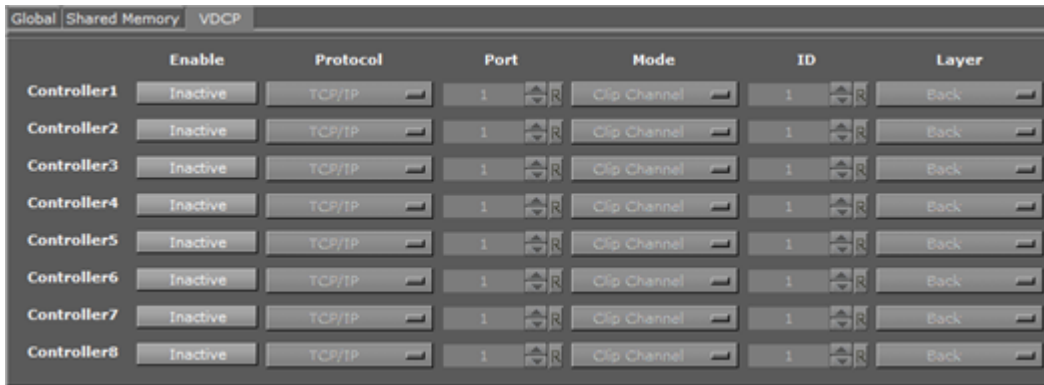

	Enable	Protocol	Port	Mode	ID	Layer
Controller1	Inactive	TCP/IP	1	Clip Channel	1	Back
Controller2	Inactive	TCP/IP	1	Clip Channel	1	Back
Controller3	Inactive	TCP/IP	1	Clip Channel	1	Back
Controller4	Inactive	TCP/IP	1	Clip Channel	1	Back
Controller5	Inactive	TCP/IP	1	Clip Channel	1	Back
Controller6	Inactive	TCP/IP	1	Clip Channel	1	Back
Controller7	Inactive	TCP/IP	1	Clip Channel	1	Back
Controller8	Inactive	TCP/IP	1	Clip Channel	1	Back

Basic control is the ability to set a clip and to start, stop, pause or continue playback of a clip, or the scene animation in the specific layer.

- **Controller <1 to 8>:** Configure up to eight external controllers. Each Controller has these parameters:
 - **Enable:** Makes the Controller connection Active or Inactive
 - **Protocol:** Selects a protocol (TCP/IP or Serial connections) for the external control device
 - **Port:** Sets a port number where an external VDCP client can connect to the specified VDCP controller of the Viz Engine.
 - **Mode:** Select a mode:
 - **Clip Channel:** Enables the control of a selected video clip channel.
 - **Layer:** Enables the control of animation in a layer.
 - **ID:** Selects a Clip channel (an ID between 1 and 16) to control. Available if **Mode** is set to **Clip Channel**.
 - **Layer:** Selects the layer. Available if **Mode** is set to **Layer**. Available options are Back, Main Or Front.

See Also

- [Shared Memory \(SHM\)](#)
- [VizCommunication.Map](#) (see the [Viz Artist User Guide](#))

7.8 Clock Formats

Format 1	hh:mm:ss	Format 11	
Format 2	h:mm:ss	Format 12	
Format 3	hh:mm	Format 13	
Format 4	h:mm	Format 14	
Format 5	hh:mm:ss.dd	Format 15	
Format 6	sss.dd	Format 16	
Format 7	ssss	Format 17	
Format 8	m:ss.dd	Format 18	
Format 9	dddd	Format 19	
Format 10	mm:ss	Format 20	

In this section, twenty various digital date and time formats can be set. Viz Engine distinguishes between uppercase and lowercase clock formats, allowing for even more customization options. Setting the clock format using lowercase letters forces Viz Engine to display the digit even if the value is 0. By defining the clock format using uppercase letters, Viz Engine omits the value if it is zero. This allows the designer to omit unused digits while still planning for their use when designing the scene.

- **Format 1-20:** Sets and enables the clock formats that may be selected in Viz Artist during scene design.

✓ **Tip:** Add a font GEOM in Viz Artist to see how the clock formats can be used.

7.9 Database

The Database section has three tabs for setting connections (i.e. a Graphic Hub, Failover servers and Deploy servers).

- [Global Properties](#)
- [Failover Properties](#)
 - [To Add Redundant Servers to the Failover List](#)
- [Deploy Properties](#)
 - [To Add Deploy Servers](#)

7.9.1 Global Properties

Use this section to configure the Graphic Hub database connection settings.

Host Name	127.0.0.1
Hub	VizDbServer
Port Number	19396
User	Guest
Additional Host Names	
Communication Timeout Settings	
Failover Timeout (sec)	15 <input type="text"/> <input type="button" value="R"/>
Global RT Timeout (sec)	30 <input type="text"/> <input type="button" value="R"/>
Establishing Timeout (sec)	15 <input type="text"/> <input type="button" value="R"/>
Show Auto Log On	<input type="button" value="Yes"/>
Auto Log On	<input type="button" value="No"/>
Import by Name	<input type="button" value="No"/>
Popup Server Messages	<input checked="" type="button" value="Enabled"/> 'Disabled' works on localhost only!
Date Format	<input type="button" value="EU"/> <input type="button" value="US"/>
Archive Bit-Mode	<input type="button" value="32 Bit"/> <input type="button" value="64 Bit"/> <small>Enable 32 Bit only if you want to ensure that archives created by this version of Viz Artist can be imported by 3.0.0 versions.</small>
Prefix Mode	<input type="button" value="No"/>
Prefix Converting Info	<input type="button" value="No"/>
Prefix Path	
Max Search Results	<input type="button" value="E 30"/> <input type="button" value="R"/> <input type="button" value="All"/> <small>It is recommended to use 'All' on small databases only!</small>
Search Date Mode	<input type="button" value="Modification"/> <input type="button" value="Creation"/>

- **Host Name:** Displays the name of the Graphic Hub naming service. The naming service is always a one to one map to the Host Name of the machine running a Graphic Hub.
- **Hub:** Displays the Graphic Hub server name.
- **Port Number:** Displays the listener port number for a Graphic Hub. The default port number is 19396, and should normally not be changed.
- **User:** Sets the default user.
- **Additional Host Names:** Displays the host name or IP address of a Graphic Hub database located on a different subnet, to make it selectable in the log onscreen database drop-down list. Multiple entries can be added, and must be separated by a semicolon. Hosts located on different subnets are highlighted in turquoise in the drop-down list.
- **Communication Timeout Settings:**
 - **Failover Timeout (sec):** Sets the maximum time to wait before a fail over is initiated from the main to the replication Graphic Hub.
 - **Global RT Timeout (sec):** Sets the maximum response time for any request to a Graphic Hub.
 - **Establishing Timeout (sec):** Sets the maximum waiting time to establish a connection to a Graphic Hub.
- **Show Auto Log On:**
 - **Yes:** Shows the **Auto Log On** check box in the Graphic Hub log on window.
 - **No:** Hides the **Auto Log On** check box in the Graphic Hub log on window.
- **Auto Log On:** Enables or disables automatic log on to a Graphic Hub. This disables the log on screen for Viz Artist/Engine.
- **Import by Name:** Checks for objects by name rather than by UUID when set to Yes. Checks by UUID when set to No.
- **Popup Server Messages:** Enables or disables popup server messages. Disabled only works on local host.

- **Date Format:** Sets the date format to EU (DD.MM.YYYY 13:54) or US (MM/DD/YY 01:54).
- **Archive Bit-Mode:** Sets the bit-mode in which the archive is saved.

⚠ Note: For compatibility, 32-bit should be enabled if scenes are imported to Viz Artist versions prior to build 2310.

- **Prefix:** Needed if an external control application is used that sends commands containing certain path locations, but where the path of the files is a different one on the Graphic Hub (e.g. because they were deployed to a specific location).
 - **Prefix Mode:** Activates the prefix mode.
 - **Prefix Converting Info:** Shows the prefixed (final) paths in the console (this behaves like the [Viz Artist 2.x](#) debug mode).
 - **Prefix Path:** Contains the prefix path string that is used for incoming commands containing path parameters.
- **Transfer Buffer Size:** Multiplies the standard buffer size of 51200 bytes by the value entered. This is only for the transfer buffer size to the Graphic Hub (Graphic Hub 2.4 and above only).
- **Max Search Results:** Sets the maximum amount of search results which should show in the search result panel (see **Item Search** and **SmartView Search** in the [Viz Artist User Guide](#)).
 - **All:** Shows all results. To set a maximum amount, deactivate **All**.

⚠ IMPORTANT! If **All** is selected this could produce a large number of search results, which may affect the performance of Viz Artist. Vizrt recommend that **All** should be used on small databases only.

- **Search Date Mode:** Selects the results date order for **Item Search** and **SmartView Search**:
 - **Modification:** Sorts search results by their modification date.
 - **Creation:** Sorts search results by their creation date.

⚠ IMPORTANT! Every time the Viz Engine connects to a Graphic Hub, it creates a mapping of all GH REST connections. This mapping is used to speed up images loading by directly downloading images from the Graphic Hub instead of using the GH REST. If the connected GH REST is reconfigured to a different Graphic Hub, then the mapping is not updated until the Viz Engine disconnects and reconnects to Graphic Hub.

7.9.2 Failover Properties

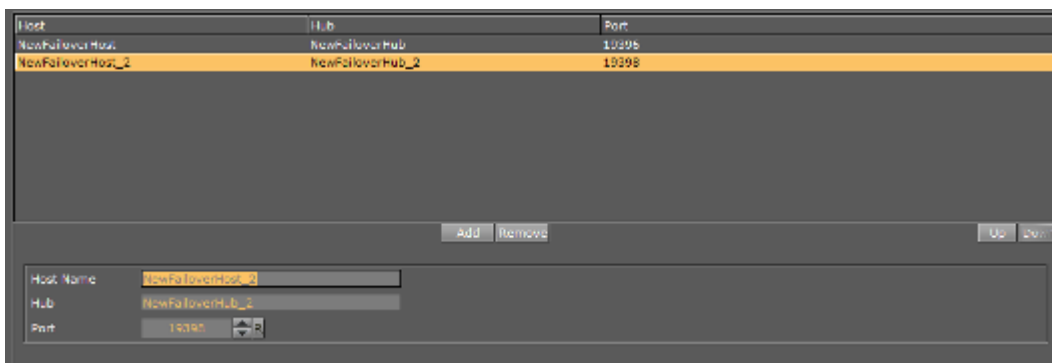

To Add Redundant Servers to the Failover List

1. Enter the **Host Name** of a Failover server.
2. Enter the Graphic **Hub** instance for Failover.
3. Enter the **Port** number of the Graphic Hub for Failover.
4. Click **Add**.
5. Use the **Up** and **Down** buttons in the database Failover list to raise and/or lower a database's priority in the event of Failover.
6. Click **Save**.

7.9.3 Deploy Properties

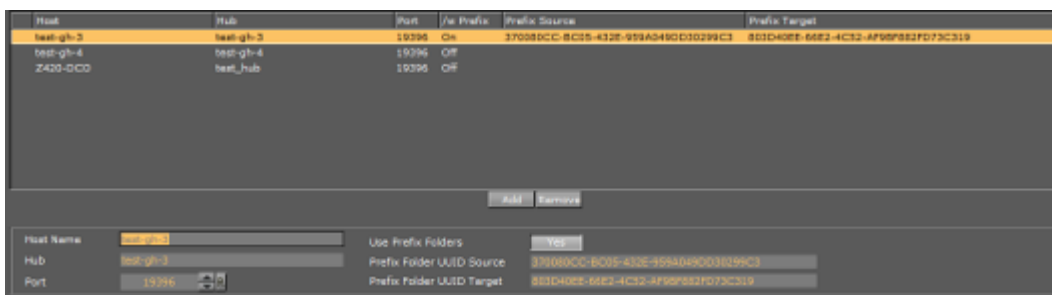

- **Added Deploy Servers Box:** Shows all available Deploy Servers.
- **Add:** Adds Deploy Servers (see [To Add Deploy Servers](#)).
- **Remove:** Removes a selected Deploy Server.
- **Host Name:** Displays the host name of the Graphic Hub machine to deploy files to.
- **Hub:** Displays the name of the Graphic Hub instance to deploy files to.
- **Port:** Displays the Graphic Hub listener port number.
- **Use Prefix Folders:** Provides a simple server copy functionality that is able to rebuild the underlying structure from a source folder on the source server to a destination folder on the destination server. All references outside the source folder are rebuilt according to the original structure, under /data/. Set to Yes to select a source and destination folder for the deployment. Set to No to keep the structure the same as on the source server. See [To Add Deploy Servers](#) below for an example setup.
 - **Prefix Folder UUID Source:** Displays the source folder UUID on the Graphic Hub to deploy from.
 - **Prefix Folder UUID Target:** Displays the target folder UUID on the Graphic Hub to deploy to.

To Add Deploy Servers

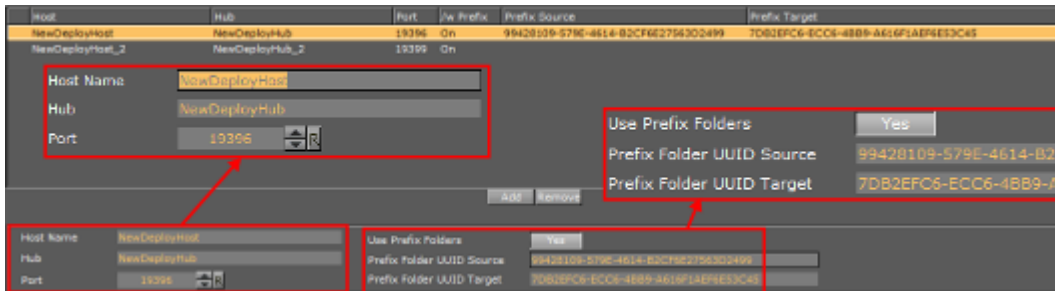

Note: To configure deploy servers, the user you are currently logged in with on the source server must exist on the destination server with the same credentials.

1. Enter the **Host Name** of a deploy server.
2. Enter the name of the deploy Graphic Hub.
3. Enter the **Port** number of the deploy Graphic Hub. The default port is 19396.
4. If specific source and destination folders are required, set **Use Prefix Folders** to Yes.
 - a. Enter the UUID of the **Prefix Folder UUID Source**.
 - b. Enter the UUID of the **Prefix Folder UUID Target**.
5. Click **Add**, and then **Save**.

See Also

- [Graphic Hub User Guide](#)

7.10 Font And Text Options

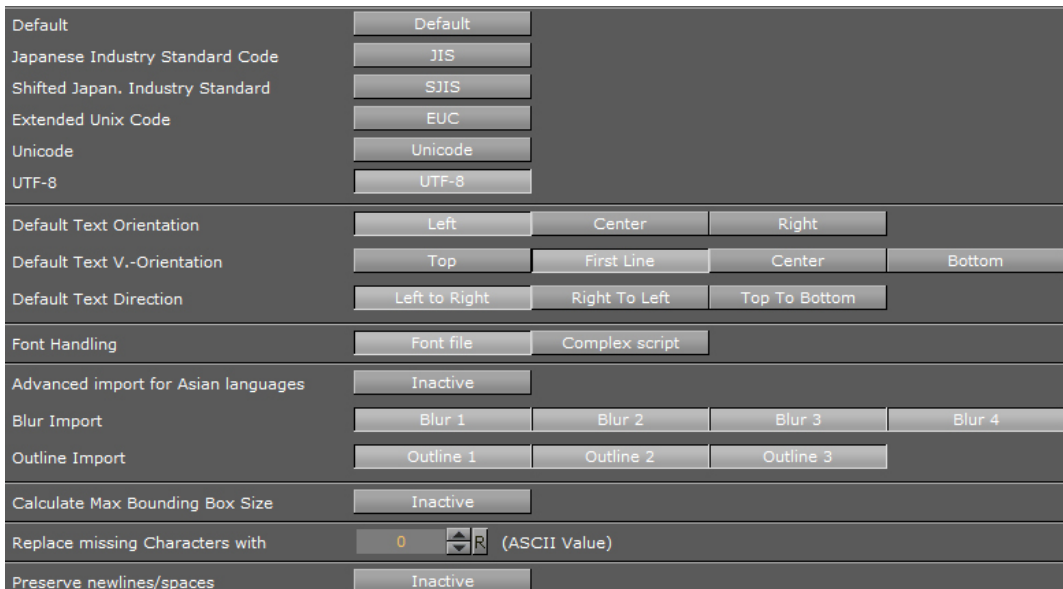

In this section, the font encoding can be configured.

- **Font encoding.** Available options are:

- **Default:** Sets the font encoding to single character interpretation (limited to 255).
- **Japanese Industry Standard Code (JIS):** Sets Japanese industry standard code character encoding.
- **Shifted Japanese Industry Standard Code (SJIS):** Sets the newer Shift JIS character encoding standard which sets aside certain character codes to signal the start of a two-character sequence.
- **Extended Unix Code (EUC):** Sets Extended Unix Code (EUC) character encoding that is a multi byte character encoding system used primarily for Japanese, Korean, and simplified Chinese.
- **Unicode:** Sets the Unicode character encoding where every two characters are inter-operated as one (not widely used).
- **UTF-8:** Sets UTF-8 (8-bit UCS/Unicode Transformation Format) character encoding that is a variable-length character encoding for Unicode.
- **Default Text Orientation:** Sets the default horizontal text orientation. Available options are *Left*, *Center* and *Right*.
- **Default Text V. Orientation:** Sets the default vertical text orientation. Available options are *Top*, *First Line*, *Center* and *Bottom*.
- **Default Text Direction:** Sets the default text direction. Available options are *Left to Right*, *Right to Left* and *Top to Bottom*.
- **Font Handling:** Sets the font handling. Available options are *Font file* or *Complex script*.
 - **Font file:** Sets the font kerning to Font file that is mainly used for languages written from left to right.
 - **Complex script:** Sets the font kerning to Complex script. Complex script is mainly used for languages written from right to left, or when one character is composed of one or several glyphs.

 **IMPORTANT!** With font handling in Complex Script mode, all fonts used must be installed in Windows to avoid unpredictable text behavior.

- **Advanced Import for Asian Languages:** Imports fonts to be used with special features (including vertical text and EUDC) when enabled. This feature is useful for some Asian languages. The fonts must be installed in the operating system.
- **Font Import:** Sets the Font import. Available options are; File (Standard) and Windows (Advanced).
 - **File (Standard):** Imports and stores fonts on the database.
 - **Windows (Advanced):** Stores only the font name on the database. For this to work the font must be installed on the Windows system where Viz Engine resides.
- **Blur Import:** Enables blur levels for fonts used in Viz 2.x scenes. These options make sure that fonts imported to Viz 3.x are recreated with all blur levels used in Viz 2.x. Available options are *Blur 1-4*.
- **Outline Import:** Enables outline levels for fonts used in Viz 2.x scenes. These options make sure that fonts imported to Viz 3.x are recreated with all outline levels used in Viz 2.x. Available options are *Outline 1-3*.
- **Calculate Max Bounding Box Size:** Enables Viz Artist/Engine 3.x to calculate the bounding boxes as they were calculated in Viz Artist/Engine 2.x. In Viz Artist/Engine 3.x a text object's bounding box height increases if a capital character is entered (e.g. an umlaut

(double dots)). In Viz Artist/Engine 2.x, the bounding box height was always the same and independent of the characters in the text object. Available options are Active and Inactive. Default is Inactive (false).

- **Replace missing Characters with:** Replaces a missing font character in a font file with a default font character. The Unicode value refers to the decimal value of the replacement character in the Unicode table (valid values are 0–65533). Normal usage would select a (42) or (95).
- **Preserve newlines/spaces:** Does not remove spaces and newlines at the end of the text when saving and reloading a scene when set to Active. This influences bounding boxes. The default state is *Inactive*.

7.11 Global Input

The Global Input settings influence the generation and handling of Six Degrees of Freedom (6DoF) messages that can be distributed to several Viz Engines.

6DoF is used when working in 3D space in combination with special input devices such as a mouse. A mouse uses two coordinates (xy) which Viz Artist/Engine is able to translate into three coordinates (xyz) based on a grid.

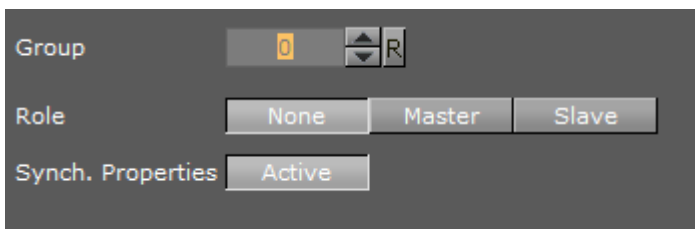

- **Group:** Defines which multicast group the generated or received messages belong to. If more than one group is to be defined, a unique Group number must be set for each group
- **Role:** Defines how messages are generated and processed. Alternatives are; None, Master and Slave
 - **None:** Generates and processes messages on the local Viz Engine only.
 - **Master:** Creates messages for itself and the defined group.
 - **Slave:** Reads and processes 6DOF messages, but is not allowed to create them.
- **Synch. Properties:** Makes the synchronization of Viz Engine Scene properties Active or Inactive.

7.11.1 To Synchronize Multiple Viz Engines

1. Start Viz Config on all involved render machines.
2. Set the same Group ID for all Viz Engines.
3. Set **Synch. Properties** to Active.
4. Save and close Viz Configuration on all machines.
5. Open the Control Panel on all render machines.
6. Deactivate all unused network connections.
 - Viz Engine always uses the first network connection setup by the Windows operating system.

- Synchronized engines work within the same network segment only because it is using multicast, hence, it is important to use the right connection.
 - The first connection can be determined by setting a manual metric in Windows: see <http://support.microsoft.com/kb/299540>.
7. Start all Viz Engines again.
 8. Create a simple test scene with a geometry and the Synchronized Properties plug-in (**Built Ins > Container > Global**) on the same container.
 9. Save the Scene.
 10. Open the Scene on all involved Viz Engines.
 11. Move the geometry on one Viz Engine. All the other Viz Engines show the same object movement.

7.12 Import 3D Options

In this section, parameters which influence the import of 3D objects can be configured. There are three different formats:

- Wavefront
- AutoCAD
- 3D-Studio

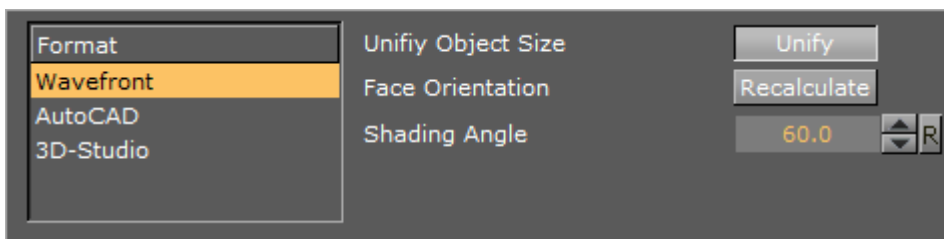

- **Unify Object Size:** Recalculates all vertices during import in a way that the object center is moved to the origin (0,0,0), and the size of the object is 100 cm in its largest extent when enabled. If disabled, all vertices retain their values as defined in the original file. An object could appear invisible in a Viz Artist scene because the object is translated a lot from the origin or is scaled up or down a lot. It may be necessary to deactivate the unification to be able to recombine several separately imported objects that must keep their size and relative position.
- **Face Orientation:** Rearranges the orientation of object faces during import when enabled. Polygonal 3D models often do not have a consistent face orientation, but for performance reasons, the Viz Artist renderer expects that all faces of an object point to the same direction.
- **Shading Angle:** Recalculates the normals from the geometry to make lighting possible, if the 3D object has no normal vector information. This recalculation is influenced by the shading angle, which acts as a threshold between sharp and soft edges.

⚠ Note: A shading angle value of 60 means that an edge between two faces is considered to be a soft edge for angles below 60 and a sharp edge above this level. 60 is the default shading angle.

7.13 Image File Name Convert

In this section, nine different replacement configurations can be set for image file names.

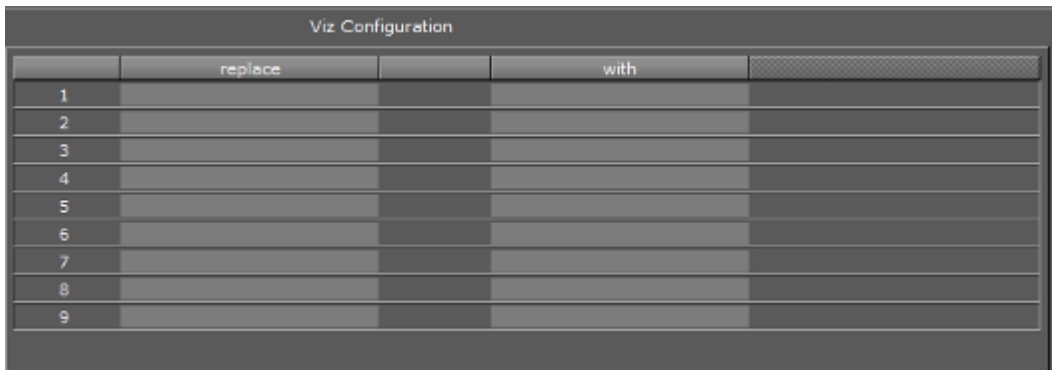

- **Replace:** Defines the string to be replaced.
- **With:** Defines the replacement string.

Example: If an image file name starts with the string `Replac` this part of the file name can be replaced by the string `With`.

7.14 Local Settings

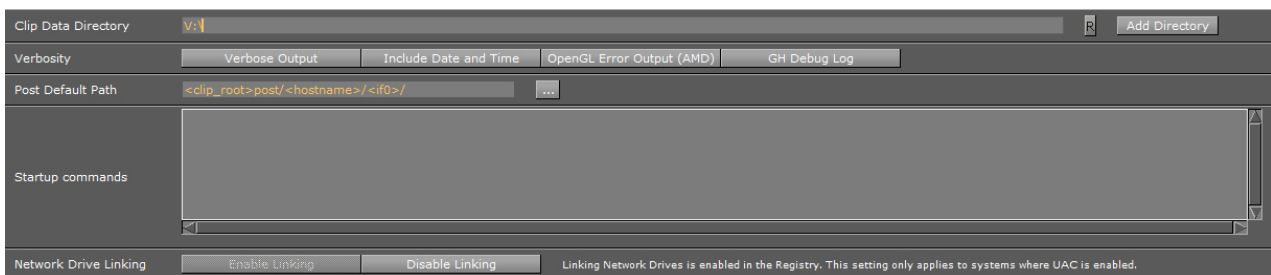

- **Clip Data Directory:** Sets the clip directory (default directory is `D:\` drive). Multiple directories can also be selected (see [Select Multiple Directories](#))

Note: This directory is also used for Viz One installations, as the root parameter for the Fsmon and Mediaftp services (see [Viz One](#)).

- **Verbosity:** Selects content of log files, if no selection is made only the default content of the log file is created:
 - **Verbose Output:** Enables the most information in the Viz Engine Console.
 - **Include Date and Time:** Enables default content of the log file with the addition of date and time.
 - **OpenGL Error Output (AMD):** Enables default content of the log file with the addition of OpenGL Error Output (AMD).
 - **GH Debug Log:** Enables default content of the log file including Write GH Connection Log.

- **Post Default Path:** Sets the default location of **Render to Disk** clips.
- **Network Drive Linking:** Enables to allow Viz Artist access to mapped network drives on certain systems where UAC is enabled.
- **Startup commands:** Saves commands that are executed on startup, but after the initial setup configuration and before the main render loop activates. Examples:

```
FEEDBACK*CLIENT ADD localhost 2001
FEEDBACK*COMMAND ADD localhost 2001 CLIPOUT
RENDERER*MAIN_LAYER SET_OBJECT Vizrt_RD/mra/Reference/TC/TC_DISPLAY
MAIN*DEBUG_CONTROL*RENDERINFO*PERFORMANCE SET 1
```

Note: Log files are written to the *<viz data folder>* directory, normally *C:\ProgramData\Vizrt\viz3*. This directory is by default hidden in Windows, so to navigate to this directory in Windows Explorer specify the explicit path. For more information see [Viz Artist/Engine Log Files](#).

7.14.1 Select Multiple Directories

More than one clip directory can be selected. When more than one directory path is selected in the **Clip Name** box, change the file path to *<clip_root>*. The included directories are parsed when executing the search, returning video clips with file names matching the search criteria.

Example: Search for a video clip named *next_tuesday.avi* in *D:\AEClips\AFL\Promos*. In the **Clip Name** box, change *D:\AEClips\AFL\Promos* to *<clip_root>*. The filename displayed in Viz Artist should be *<clip_root>\next_tuesday.avi*.

Note: The directory has to match the directory set when the Mediaftp service for video transfer from Viz One was installed.

Multiple directories can be used with:

- Dual Channel and Trio Box CG configurations, or
- With any Viz Artist/Engine configuration for the selection of a secondary video clip directory if a directory fails.

If the file path for a video clip is set to *<clip_root>* and the first directory fails, the same video file is searched for in the next directory in the Clip directory list. If the **Clip Name** box is used to search for a video when multiple Clip directories are selected, the search defaults to the last used directory.

7.14.2 SAM SDC01, SDC02, and SDC03 protocols

To enable or disable a supported SAM protocol please change the *SAMSDC0x_enable*. By default those protocols are switched off. The listening is changed with *SAMSDC0x_address*. If one needs to configure multiple instances those listening addresses need to be unique among the Viz Engine instances.

SAM SDC01

```
## enable the SAM SDC01 protocol. This is disabled by default.  
#* SAMSDC01_enable: Default=0  
SAMSDC01_enable = 1  
## the SAM SDC01 protocol listening endpoint.  
#* SAMSDC01_address: Default=0.0.0.0:2055  
# SAMSDC01_address = 0.0.0.0:2055
```

and

SAM SDC02

```
## enable the SAM SDC02 protocol. This is disabled by default.  
#* SAMSDC02_enable: Default=0  
SAMSDC02_enable = 1  
## the SAM SDC02 protocol listening endpoint.  
#* SAMSDC02_address: Default=0.0.0.0:2056  
# SAMSDC02_address = 0.0.0.0:2056
```

and

SAM SDC03

```
## enable the SAM SDC03 protocol. This is disabled by default.  
#* SAMSDC03_enable: Default=0  
SAMSDC03_enable = 1  
## the SAM SDC03 protocol listening endpoint.  
#* SAMSDC03_address: Default=0.0.0.0:2057  
# SAMSDC03_address = 0.0.0.0:2057
```

See Also

- [Clip Properties](#) in the [Viz Artist User Guide](#)

7.15 Maps

Map Server	<input type="button" value="Active"/>			
Server	cra-maps			
Project				
Available				
Map Size	Width	512	Height	512
Cache Directory	C:\temp			
Memory (Images)	32	On disk (Days)	15	
2nd Cache Directory	C:\temp			Viz World Version 12.0 And Above
Priority	0	Network Monitor	<input type="button" value="Inactive"/>	
Attribution Font	Verdana			
Bold	<input type="button" value="On"/>	Italic	<input type="button" value="Off"/>	
On Top	<input type="button" value="Off"/>	On Right	<input type="button" value="Off"/>	

- **Map Server:** Enables or disables Viz World Server (WoS) connection for Viz World Client (WoC). If there is a problem with the Viz World installation, an error message is displayed next to the Active/Inactive button.
- **Server:** Sets the Viz World Server host.
- **Project:** Sets the default map project that opens with the client application.
- **Available:** Lists all available Viz World Server projects.
- **Map size:** Sets the default map size that is used with the client application.
- **Cache Directory:** Sets the cache directory for cached maps which can be a local drive, mapped drive or a Universal Naming Convention (UNC) path.

IMPORTANT! Make sure the Cache Directory folder is configured with read and write access rights.

- **Memory (Images):** Sets the number of images to keep in memory.
- **On disk (Days):** Sets the number of days to save images on disk.
- **2nd Cache Directory:** Enables a second cache (see Cache above). The main purpose of the second cache is to enable redundancy in those cases where a main cache directory is on a different computer and for some reason fails. Another use case is to use it as a local cache to save loading time in more complex operations. To shorten load time, copy large static files to the correct local cache folder. In the *3D Map Setting* plug-in, there is a **Sync Local Cache Folder** button which copies all required files to the local cache. Note that the second cache directory settings can only be used by Viz World version 12.0 and later.
- **Priority:** Sets the machine's connection priority to the Viz World Server (Wos). Setting a number, where 1 is the lowest and 100 is the highest you may override connection priorities set by other machines. The configuration interface allows you to prioritize client connections

from Viz Artist and On Air Viz Engine's used for preview and program output. Viz Engines must be in On Air mode for them to be prioritized. For Viz World Map Editor you can set it from its context menu. To enable this behavior on the server side you need to enable WoS to prioritize its connections/log ins. For more information, see the [Viz World User Guide](#), *Server Launcher Configuration* section. If the configuration option is not visible, [add the VizWorld.ini file](#) and set the priority.

- **Network Monitor:** Enables you to monitor relevant network connections (server and cache folders). If you do not monitor the network and you try to connect over a disconnected network, connecting to a server or a UNC path, it takes time before the system reports back (e.g. 30 seconds or more). Enabling network monitoring avoids such connection issues. Note that the network monitor only monitors a cache folder that uses a UNC path (not mounted/mapped drives). If the configuration option is not visible you need [add the VizWorld.ini file](#).
- **Attribution Font:** Sets the font for the attribution.
- **Bold:** Sets the attribution font to **bold**.
- **Italic:** Sets the attribution font to *italic*.
- **On Top:** Places the attribution image to the top in the screen. Default is bottom.
- **On Right:** Places the attribution image to the right in the screen. Default is left.

7.15.1 To Add the VizWorld.ini File

1. Create and save a *VizWorld.ini* file to the following location: *<viz install folder>\plugin\data\maps*.
2. Open the file and enter the following:

```
Monitor=1 Priority=1 Language=[my Language ID]
```

3. **Save** the file and start, for example Viz Config, to see the configurable parameters.
 - **Monitor** enables network monitoring. For more information see the **Network Monitor** setting under the [Maps](#) section.
 - **Priority** sets Viz connection priority to the Viz World Server. For more information, see the [Viz World User Guide](#).
 - **my Language ID** refers to the order of languages in your list of languages (e.g. English = 0, Arabic = 1, Hebrew = 2 and so on).

For more information see the **Languages** setting under the [Maps](#) section.

7.16 Matrox

In the Matrox section, assign Matrox Input and Output channels to Viz Engine Input and Output channels. The GUI shows a drop down menu for the configurable parameters. The parameters available are dependent on the installed hardware.

This page provides information about the following:

- [General Properties](#)
- [VideoOut Properties](#)

- [Map to Viz Channel](#)
- [Fill Properties](#)
- [Key Properties](#)
- [Manager, Repeat and 3G Properties](#)
- [VBI Properties](#)
- [VideoIn Properties](#)
 - [Map to Viz Channel](#)
 - [Allow Properties](#)
 - [Key Properties](#)
 - [Video Properties](#)
 - [VBI Properties](#)
 - [Audio Properties](#)
 - [M264 Encoder/Decoder Boards](#)

7.16.1 General Properties

The General Properties Panel shows information about the installed hardware.



- **Serial No.:** Shows the serial number of the installed Matrox board.
- **Board Info:** Shows the model and type of the Matrox board.
- **DSX Info:** Shows the software version and driver version.
- **Fast Texture Mode:** Activate to shorten the 'in out' delay in Texture Mode to a minimum.

⚠ Note: If **Fast Texture Mode** is set to **Active**, **DVE** does not work (see **Video Clip Playout Considerations** and **Video Playout** in the [Viz Artist User Guide](#)).

- **CC Extraction:** Enables or disables the closed captioning extraction for [Matrox X.mio 3 / DSX LE 4](#) and [X.mio2+](#).
- **Print Clip Info:** Enables printing of clip information to the console when activated. However, such information may cause the render loop to stall. Default mode is *Inactive*.
- **Watchdog:** Sets a timer that allows a system to continue video pass-through during an application crash or system failure (see also [Matrox Watchdog Configuration \(Matrox X.mio Series\)](#) and [Video Board](#)):

- **Use Watchdog:** When set to **Active** enables the Matrox X.mio watchdog feature. It passes the input signal to a hardcoded output port as soon as Viz Engine is unresponsive. Default mode is *Inactive*.
- **Timeout:** Sets the time, in milliseconds, until the watchdog takes over control. This value should not be smaller than the time of two fields/frames. Default value is 999 ms.

Note: Use **Watchdog** and **Timeout** can also be set and changed in [Video Board](#).

- **Genlock:**
 - **Use Flywheel:** Adopts a tracking mode if the genlock signal is interrupted or lost that maintains the signal frequency until the source genlock signal is regained when activated. Default mode is *Active*.
 - **Max Recovery Time:** Represents the time in milliseconds (ms) provided to the flywheel to attempt to regain the genlock before an abrupt jump to the locked state is performed. Default value is 15.
 - **Max Unlock Time:** Represents the time in milliseconds (ms) provided to the flywheel to remain in the unlocked state before switching to the free running state. Default value is 15.

7.16.2 VideoOut Properties

In the VideoOut panel, you select which Viz Artist/Engine Output is mapped to the selected Matrox output. The VideoOut panel shows the mapped Viz output channel and its editable parameters. When your video input is set to *UHD* in the Video Input section of the config menu (see [Video Input](#)), Matrox channels B, C and D are disabled.



Map to Viz Channel

- **Map to VizChannel:** Selects which video out channel is mapped to the selected Matrox video out channel. Select an Output channel from the drop-down menu. Only channels not already in use are shown. On single channel configurations, **VideoOut A** is usually mapped to **Program**, and **VideoOut B** to **Preview**. On *dual* Channel configurations, the first channel maps **VideoOut A** to **Program**, and the second maps **VideoOut B** to **Program**.
 - **Unused:** Does not map this Matrox channel for output.
 - **Program:** Maps the Program output to the selected video output of the Matrox card.
 - **Preview:** Maps the Preview output to the selected video output of the Matrox card.
 - **Clean:** Outputs video without overlay graphics. Clean mode enables and activates a second output feed. This feed consists of DVE video content without any graphics and video textures: only live video, clip video, IP input, streaming input. This stream also includes a separate audio mix corresponding to the video only, excluding stage audio such as audio clips, plug-in audio or text-to-speech, from the clean feed audio mix. If Watchdog functionality is required, **VideoOut A** must be mapped to **Clean**, and **VideoOut B** to **Program**. Requires Matrox X.mio3, X.mio3 IP, or DSX LE4.

 **Note:** A clean feed increases the video In->Out delay by one frame!

Fill Properties

- **Allow Super Black:** Determines whether to clip an output video signal that is under 7.5 IRE units. Default mode is *Inactive*.
- **Allow Super White:** Determines whether to clip an output video signal that is over 100 IRE units. Default mode is *Inactive*. The colorimetry tables for SD (ITUR-BT 601) and HD (ITUR-BT 709) define a color conversion from YUV with the range of 16-235 to RGB with the range of 0-255. Values above 235 are Super White and values below 16 are Super Black. As Super White and Super Black pixels are outside the range of 1-byte RGB, these pixels are clamped to the normal 16-235 YUV range when used in a texture.
- **Allow Chroma Clipping:** Determines whether to clip over-saturated chroma levels in the active portion of the output video signal. Default mode is *Inactive*.
- **Digital Edge Sharpening Filter:** Applies an edge sharpening filter to digital output video. Default mode is *Inactive*. SD configurations only.

Key Properties

- **Watchdog Key Opaque:** Specifies if the output key must be opaque or transparent when the watchdog unit activates. Default mode is *Inactive*.
- **Allow Super Black:** Determines whether to clip an output video signal that is under 7.5 IRE units. Default mode is *Inactive*.
- **Allow Super White:** Determines whether to clip an output video signal that is over 100 IRE units. Default mode is *Inactive*.

Note: Please see the description about allowing Super White and Super Black in the **Fill Properties** section above.

- **Allow Chroma Clipping:** Determines whether to clip over-saturated chroma levels in the active portion of the output video signal. Default mode is *Inactive*.
- **Apply Offset:** Applies an offset to the luminance values such that the inverted result still falls within the 16-235 range. Default mode is *Inactive*.
- **Downscale Luma:** Compresses the luminance range of the output key signal from 0-255 to 16-235. Default mode is *Active*.
- **Invert Luma:** Inverts the luminance part of the output key signal (inverts the key). Default mode is *Inactive*.

Manager, Repeat and 3G Properties

- **Manager Size (frames):** Sets the number of frames available in the on-board memory for output. A too high value may cause memory problems on the Matrox board. Default value is 3.
- **Repeat Mode:** Defines the way the output should be repeated if Viz Engine is stalled and does not update the output. Default mode is Field. Available modes are:
 - **None:** Does not repeat. Output goes black.
 - **Field:** Repeats the last played field.
 - **Frame:** Repeats the last played frame.
- **3G Level B:** Activates Level B for 3G mode in 1080p 50/60/60M (default mode is Level A).

VBI Properties

Use this switch to enable or disable VBI (Vertical Blanking Interval) in the output.



7.16.3 VideoIn Properties



The VideoIn tab shows the mapped Viz Engine channel together with modifiable input channel settings.



VideoIn A (1/5) 



Map to Viz Channel

ProcAmp

Brightness   

Lumagain   

Hue   

Saturation   

Allow Super Black

Allow Super White

Allow Chroma Clipping

Key

Contains Alpha



Key Apply Offset



Key Upscale Luma



Key Invert Luma



Shaped



Video

Manager Size   

Streaming Size   

Texturemanager Size   

Video Delay DVE   



Video Delay Texture   



Repeat Mode

3G Level B

VBI

VBI



Delay DVE   



Delay Texture   

Audio

Audio

Channels

Delay DVE   

Delay Texture   

Map to Viz Channel

- Set which video in channel is mapped onto this Matrox video in channel. The drop-down gives a choice between the available channels. Only the channels not already taken are shown.
 - **Unused:** Do not use this Matrox channel for video input
 - **Video <1 to 8>:** Captured input is available in *Video1*.

Note: On a single channel configuration **VideoIn A** is usually mapped to Video1 and **VideoIn B** to Video2 and so on whereas for a Dual Channel configuration usually the first channel maps **VideoIn A** to Video1 and the second channel maps **VideoIn B** to Video1. In this case both the first and the second channel have one video input configured, namely Video1.

Note: Input nodes can be shared among multiple engines instances for versions 3.12 and later.

Allow Properties

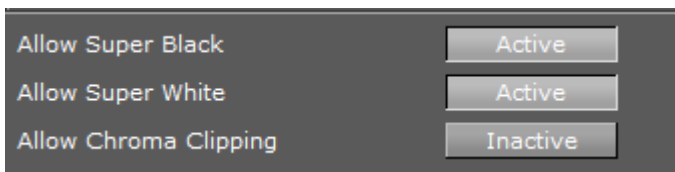

- **Allow Super Black:** Determines whether to clip an input video signal that is under 7.5 IRE units. Default mode is *Active*.
- **Allow Super White:** Determines whether to clip an input video signal that is over 100 IRE units. Default mode is *Active*.
- **Allow Chroma Clipping:** Determines whether to clip over-saturated chroma levels in the active portion of the input video signal. Default mode is *Inactive*.

Key Properties

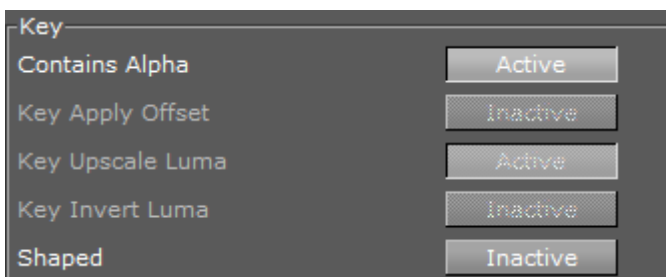

- **Contains Alpha:** Enables/Disables use of alpha component.

Note: This switch is only enabled on input channels where capture with alpha is supported.

- **Key Apply Offset:** Applies an offset to the luminance values so that the inverted result still falls within the 16-235 range.
- **Key Upscale Luma:** Expands the luminance range of the input key signal from 16-235 to 0-255.
- **Key Invert Luma:** Inverts the luminance part of the key signal (inverts the key).
- **Shaped:** Enables/Disables capture in shaped format.

Video Properties



- **Manager Size:** Sets the number of frames available in the on-board memory for capturing. This value is influenced by the input delays specified in the parameters below and is automatically adjusted if it is too low. A too high value may cause memory problems on the Matrox board. Default value is 6.
- **Streaming Size:** Not in use.
- **Texturemanager Size:** Defines the size of the texture buffer in frames. Default value is 8.
- **Video Delay DVE:** Sets the number of frames the live input should be delayed before it can be used as a DVE layer. Default value is 0 (off).
- **Video Delay Texture:** Sets the number of frames the live input should be delayed before it can be used as a texture in the scene (default value is 4, also the minimum value. The maximum value is 50).

Note: Viz Engine ships with preconfigured profiles for a minimum AV delay for all Matrox boards and all major resolutions. Please be sure to apply these settings. Usually, there is no need to tweak the delay settings except special situations like frame accuracy settings etc..

- **RP188 Enable:** Enables capturing of SMPTE RP 188 extra information such as LTC and VITC. Default is *Inactive*.
- **Repeat Mode:** Determines the behavior of the video input in case of capture drops. Options are:
 - **None:** Does not repeat. Input goes black.

- **Field:** Repeats the last field.
- **Frame:** Repeats the last frame.
- **3G Level B:** Activates Level B for 3G mode in 1080p 50/60/60M (default mode is Level A).

VBI Properties

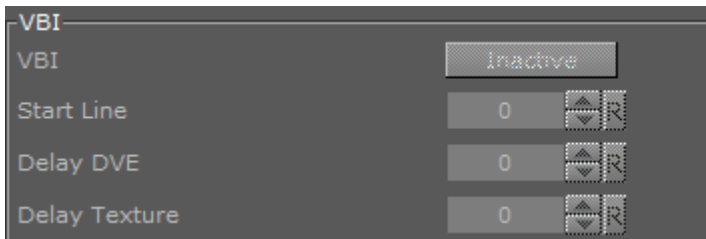

- **Enable:** Enables VBI for this channel when set to Active. Default is Inactive.

Note: This setting can only be activated if input and output resolution match.

- **Start Line:** Defines at which line on the input the VBI section starts. Default value is 0 (Off). The minimum VBI values are (as for VideoOut):
 - **NTSC:** 7
 - **PAL:** 6
 - **720p:** 7
 - **1080i:** 6
- **Delay DVE:** Sets the number of frames the VBI should be delayed before the clip can be used in DVE mode. Default is 0 (Off).
- **Delay Texture:** Sets the number of frames the VBI should be delayed before the clip can be used in texture mode. Default is 0 (Off).

Audio Properties

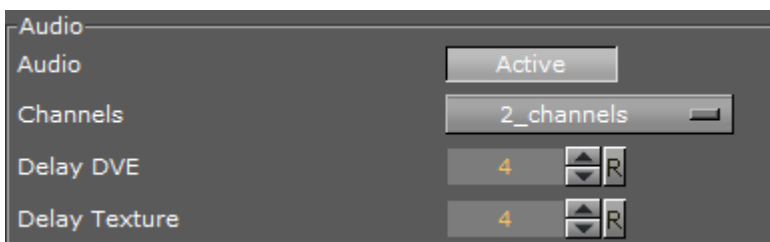

- **Audio:** Enables audio capturing on this channel when set to Active. Default mode is Active.
- **Channels:** Sets the number of audio channels to capture (see also [Audio in Viz](#)). Default number of channels are 2. Available channel options for AES on X.mio are: None, 1, 2, and 4. For AES on X.mio2/X.mio2 Plus and for Embedded the channel options are: None, 1, 2, 4, 8, and 16.
- **Delay DVE:** Sets the number of frames the audio should be delayed in DVE mode before it can be mixed to the output. Default value is 4.
- **Delay Texture:** Sets the number of frames the audio should be delayed in texture mode before it can be mixed to the output. Default value is 4.

M264 Encoder/Decoder Boards

M264 encoder/decoder boards are usually configured automatically. If they do not appear in the configuration section, please double check the `Matrox.Devices` entry in the **MATROX_CONFIG** of the `viz.cfg` file.

It should look like `Matrox.Devices = <device1>,<device2>`.

Depending on your model, e.g. a M264 S3, which supports three streams, the entry would look like: `Matrox.Devices = <device1>,<m264device>,<m264device>,<m264device>`.

7.17 Memory Management

Free Image Data	<input type="radio"/> No <input checked="" type="radio"/> On-air <input type="radio"/> Always
Free Images	<input checked="" type="radio"/> On
Free Fonts	<input checked="" type="radio"/> On
Free Memory Threshold (MB)	0 <input type="button" value="▲"/> <input type="button" value="▼"/> <input type="button" value="R"/>
Delayed Object Cleanup (min)	0 <input type="button" value="▲"/> <input type="button" value="▼"/> <input type="button" value="R"/>
Preload Textures	<input type="radio"/> Off
Free Now	<input type="radio"/> Scenes <input checked="" type="radio"/> Geometries <input type="radio"/> Images <input type="radio"/> Fonts <input type="radio"/> All
Spawned Process Threshold	0 <input type="button" value="▲"/> <input type="button" value="▼"/> <input type="button" value="R"/>

Application memory management involves supplying the memory (main memory and graphic card memory) needed for a program's objects and data structures used for in-memory objects such as images, fonts and so on from the limited resources available. Memory management also recycles memory for reuse when required and appropriate.

In the Memory Management section of the configuration, you can give detailed hints to the Viz Engine how memory should be handled:

- **Free Image Data:** Frees image data after texture creation when enabled (On Air or Always).

⚠ Note: If an image is modified, then its texture is rebuilt faster if the data already lies in the main memory (instead of re-loading it from the database).

- **No:** Disables the Free Image Data option. This option is faster, but requires a lot of memory.
- **On-air:** Frees image data when in On Air mode, but not in Viz Artist mode.
- **Always:** Frees image data every time after the texture was created. This option saves a lot of memory but is slower in case of texture rebuilds.
- **Free Images:** Removes unused images (i.e. not referenced in a loaded scene) from the Image Pool (main memory and graphics card memory) when enabled (*On*).
- **Free Fonts:** Removes unused fonts from the Font Pool when enabled (*On*).

- **Free Memory Threshold (MB):** Attempts to automatically unload unused Pool objects until the specified amount of main memory is free again if set to greater than zero (>0).
- **Delayed Object Cleanup (min):** Sets the delay to clean up pool objects. Default: 0 minutes which effectively disables the delayed clean up. If set to a value greater than 0, objects do not immediately get deleted when unloaded from the renderer, and keeps objects in memory for subsequent use. While this improves performance for certain scenarios, it increases the memory footprint of Viz Engine.
- **Preload Textures:** Loads all images which are to be loaded with a Scene (they do not need to be rendered) as textures on the graphics card when enabled (on). This eliminates the texture creation time during rendering afterwards (e.g. useful when initializing a show or a playlist). Default is disabled (off).
- **Free Now:** Frees the selected unused Pool objects (Scenes, Geometries, Images, Fonts or All) from the memory.
- **Spawned Process Threshold:** Sets the maximum number of child processes spawned by Viz. If the number of child processes exceed the set value, a pool cleanup is automatically triggered. When set to 0, automatic cleanups are disabled. The default value is 0.

7.18 Multiview

The Multiview feature provides the possibility to show a preview of channels (including live and clips) and do the actual rendering of the program on the same system. The channel preview is shown in a separate window. The *Viz Opus* system utilizes Multiview for preview, providing an efficient and cost-effective “TV in a Box” solution.

Two GPUs are required for this setup. One GPU is used for rendering and the other one to show the preview. This to make sure the Engine rendering is not affected by the preview window.

Multiview is disabled by default, but can be enabled by editing the Engine configuration file and changing the Multiview configuration setting to `set enable_media_preview = 1`. Follow these steps:

- Locate the Viz Engine configuration file, normally in `C:\ProgramData\vizrt\viz3`. For security, copy the configuration file to a backup location before making changes.
- Change the following entries as appropriate and make sure to save the configuration file as a text-file. The Viz Engine needs to be restarted for the changes to take effect.

```
## Enable multiview feature. Disabled by default.
enable_media_preview = 1
## Set the GPU on which Multiview should be executed. (one based)
media_preview_affinity_gpu = -1
## Set the update frequency for Multiview.
media_preview_update_freq = 1
```

Parameters:

- `enable_media_preview = 0` or `1` (1 = enabled, 0 = disabled)
- `media_preview_affinity_gpu = -1` (-1 for preview not enabled. If enabled: 1 = GPU1, 2 = GPU2 and so on)

- `media_preview_update_freq = 1` (Refresh rate. E.g. 1 means that one preview channel is updated every render cycle.)

See Also

- [Viz Opus information](#) (external link)

7.19 Path Aliases

In this section, up to five favorite archive and ten import paths can be set. These are accessible through Viz Artist's Archive and Import panes.

Name	Archive-Export-Path	
		...
		...
		...
		...
		...
Name	Import-Path	
		... Fonts
		... Images
		... Geometries
		... Scenes
		... Audio
		... Archives
		... Videos
		... Substances
		... Images
		... Images

- **Name:** Sets the path alias name for the archive or import path.
- **Path:** Sets the archive or import path which can be a local drive, mapped drive or a Universal Naming Convention (UNC) path.

! **IMPORTANT!** Make sure the archive folder is configured with read and write access rights.

7.19.1 To Add a Path

1. Enter a descriptive name in the **Name** field.
2. Enter a path in the **path** field, or click the **Browse** button to navigate and select a path.
3. Assign a type. Options are:

- Fonts
- Images
- Geometries
- Scenes
- Audio
- Archives
- Videos
- Substances

In this way, when clicking on an alias before a file is imported, the import window automatically opens the designated folder and switches to the assigned type.

4. Click **Save**.

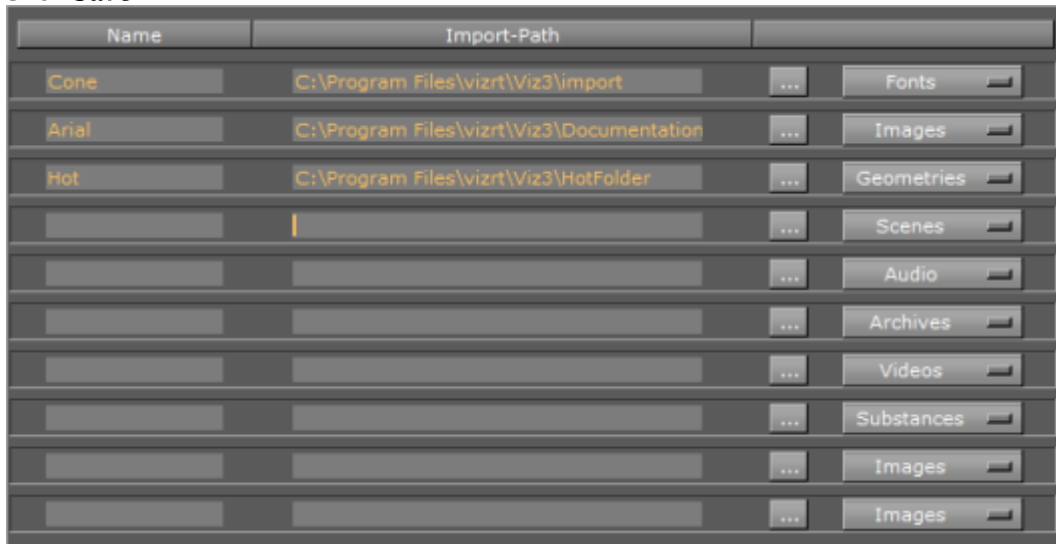

7.20 Output Format

You set the output format of the rendering engine on this panel. *All* video hardware configurations are associated with the video standard set here as output format. This setting also defines the frequency (frame rate) at which Viz Engine runs.

Name	Specification	Dimension	Frequency	Aspect
NTSC	480I_5994_SMPTE259_NTSC	720 x 486	59.94 Hz	4:3
NTSC	480I_5994_SMPTE259_NTSC	720 x 486	59.94 Hz	16:9
PAL	576I_5000_SMPTE259_PAL	720 x 576	50.00 Hz	4:3
PAL	576I_5000_SMPTE259_PAL	720 x 576	50.00 Hz	16:9
720p HD Progressive	720P_5000_SMPTE296	1280 x 720	50.00 Hz	16:9
720p HD Progressive	720P_5994_SMPTE296	1280 x 720	59.94 Hz	16:9
720p HD Progressive	720P_6000_SMPTE296	1280 x 720	60.00 Hz	16:9
1080i HD Interlaced	1080I_5000_SMPTE274	1920 x 1080	50.00 Hz	16:9
1080i HD Interlaced	1080I_5994_SMPTE274	1920 x 1080	59.94 Hz	16:9
1080i HD Interlaced	1080I_6000_SMPTE274	1920 x 1080	60.00 Hz	16:9
1080p HD	1080P_23976_SMPTE274	1920 x 1080	23.976 Hz	16:9
1080p HD	1080P_2500_SMPTE274	1920 x 1080	25.00 Hz	16:9
1080p HD	1080P_2997_SMPTE274	1920 x 1080	29.97 Hz	16:9
1080p HD	1080P_5000_SMPTE424M	1920 x 1080	50.00 Hz	16:9
1080p HD	1080P_5994_SMPTE424M	1920 x 1080	59.94 Hz	16:9
1080p HD	1080P_6000_SMPTE424M	1920 x 1080	60.00 Hz	16:9
2160p UHD TV1	2160P_2500_UHDTV1	3840 x 2160	25.00 Hz	16:9
2160p UHD TV1	2160P_2997_UHDTV1	3840 x 2160	29.97 Hz	16:9
2160p UHD TV1	2160P_3000_UHDTV1	3840 x 2160	30.00 Hz	16:9
2160p UHD TV1	2160P_5000_SMPTE2036_UHDTV1	3840 x 2160	50.00 Hz	16:9
2160p UHD TV1	2160P_5994_SMPTE2036_UHDTV1	3840 x 2160	59.94 Hz	16:9
2160p UHD TV1	2160P_6000_SMPTE2036_UHDTV1	3840 x 2160	60.00 Hz	16:9

For PAL and NTSC, you can set aspect ratio to 4:3 (standard TV) and 16:9 (wide screen TV).

Fullscreen sets the output format to the screen size of the current machine. Fullscreen also allows modification of frame rate setting, but not other settings. Viz Engine supports UHDTV and 4K (see [UHDTV and 4K Support](#)). UHDTV and 4K formats are only displayed when the system hardware supports it.

Click **User Defined** to open a panel below the output format list. You can employ User Defined output format to fit the requirements of multi-pipe systems, such as a video wall. Configure the multi-pipe settings in the right part of the editor.

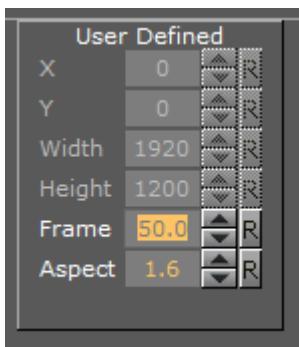

- **X:** Sets the horizontal alignment in pixels on the screen. Value is calculated from top left of the screen.
- **Y:** Sets the vertical alignment in pixels on the screen. Value is calculated from top left of the screen.
- **Width:** Sets the width in pixels.
- **Height:** Sets the height in pixels.
- **Frame:** Sets the refresh rate/frequency per frame in hertz (Hz).
- **Aspect:** Sets the aspect ratio. For example 1.778:1 which is 16:9 or 1.333:1 which is 4:3. The designer can set other aspects ratio for each individual scene, as described in the **Scene Settings** page in the **Scene Management** section of the [Viz Artist User Guide](#).

Note: Make sure that the physical refresh rate of the graphics hardware and the video hardware are configured with compatible settings.

There are three frequency groups/families; 50, 59,94 and 60 Hz. This defines the output format, and how fast Viz Engine operates. The frequency is the same as frames per second. This also

defines the input format that is allowed; hence, an NTSC SD input cannot produce a PAL SD output, but an HD input with the same frequency as the SD output would work.

7.20.1 UHDTV Support

- UHDTV resolution is currently supported on [Matrox X.mio 3 / DSX LE 4](#) and [Matrox DSX LE3 Series 4](#).
- For most applications, [Matrox X.mio 3 / DSX LE 4](#) or [X.mio3 12G](#) is the preferred video board.

7.21 Plug-Ins

The Plug-ins panel lists all installed plug-ins recognized as valid. To display all information correctly, you must open Viz Config from Viz Artist, as the plug-ins are not actually loaded in the Viz Config standalone application. However you can still enable or disable the loading state. Some unlicensed plug-ins do not load, while others do. In the latter case, a watermark is shown. Viz Artist/Engine does not load inactive plug-ins during run-time. If a scene uses a plug-in that is deactivated, Viz Artist/Engine is unable to activate it without restarting.

Name	Filename	Version	req. Viz V.	Loading	State
Default	2DLine.vip	1.0.1	No V-Req.	OK	OK
Default	2DFlash.vip	2.0.3	No V-Req.	OK	OK
Default	2DRibbon.vip	2.0.5	No V-Req.	OK	OK
Default	AlphaMap.vip	1.0.2	No V-Req.	OK	OK
VizDataTools	AreaChart.vip	1.2.14	No V-Req.	OK	OK
Default	Area.vip	1.0.3	No V-Req.	OK	OK
VizDataTools	BarChart.vip	1.2.14	No V-Req.	OK	OK
Default	Circle.vip	1.1.9	No V-Req.	OK	OK
BaseFX	Cube.vip	1.0.3	No V-Req.	OK	OK
Default	Copypaste.vip	1.0.3	No V-Req.	OK	OK
Default	Cone.vip	1.0.3	No V-Req.	OK	OK
Default	Connector.vip	1.1.9	No V-Req.	OK	OK
Default	Cube.vip	1.0.3	No V-Req.	OK	OK
Default	Cylinder.vip	1.1.9	No V-Req.	OK	OK
Default	Cylinder2.vip	1.2.9	No V-Req.	OK	OK
Default	Dexter.vip	1.0.2	No V-Req.	OK	OK
Default	DisplacementMap.vip	1.0.3	No V-Req.	OK	OK
Default	Ellipse.vip	1.1.9	No V-Req.	OK	OK
Default	Field_Rectangle.vip	1.1.9	No V-Req.	OK	OK
Default	Flare.vip	1.1.9	No V-Req.	OK	OK
Default	Grid.vip	1.0.3	No V-Req.	OK	OK
Default	Grid2D.vip	1.0.1	No V-Req.	OK	OK
Default	icosahedron.vip	1.1.9	No V-Req.	OK	OK
Default	ImageFX.vip	1.0.1	No V-Req.	OK	OK
VizDataTools	LineChart.vip	1.2.14	No V-Req.	OK	OK
Default	Noisy.vip	1.1.9	No V-Req.	OK	OK
RenderCore	Render.vip	1.1.9	No V-Req.	OK	OK
VizDataTools	RectChart.vip	1.2.14	No V-Req.	OK	OK
Default	Render.vip	1.0.3	No V-Req.	OK	OK
PostFX	pxRenderEnergyBot.vip	1.2.9	No V-Req.	OK	OK

Plug-in categories are:

- **Geometry**
- **Container**
- **Scene**
- **Shader**
- **Fontstyle**
- **RenderToDisk**
- **Inactive**

For detailed information about the various available plug-ins, see the [Viz Artist User Guide](#) in these sections:

- Geometry Plug-ins
- Container Plug-ins
- Scene Plug-ins
- Shader Plug-ins

All plug-ins can individually be activated or deactivated. If a plug-in is inactive it is not loaded at startup. All inactive plug-ins are listed under the **Inactive** panel. Click the drop-down menu to select a plug-in category.

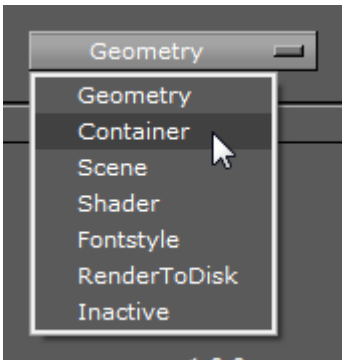

See Also

- [Viz License Information](#)

7.22 Render Options

Keep Editing Aspect	Off	Editor	No Video	Resize GUI		
Render Method	Off	Display Lists	VBO			
Extended Color Space	Inactive					
Full Scene AA	None	4 Samples	8 Samples	16 Samples		
Fill Mode	Direct	Unshaped	Shaped			
Use Fill Mode	Inactive	(for NLE and Post Production)				
RGB to YUV	Shader	Matrox				
On Air Mouse Cursor	Active					
Execute All Animations	Active					
Frame Counter	Incremental	OpenGL	System	Incremental Video Wall		
Frame Speed	Full	Half	Third	Quarter	Fifth	Sixth
Force Ringing Filter Off	Inactive					
Image Combining	Software	Multi Texturing				
Key Render Mode	Single Pass	Double Pass				
Sync. DirectShow	Inactive					
Image Load Error	Keep Old Image	Clear Image				
Render Scale	1.2					
Aux Rendering	Inactive					
Aux Camera	1					

In this section, the following render options can be set:

- **Keep Editing Aspect:** Influences scene designs in Viz Artist mode. Options are:
 - **Off:** Shows scenes only in Anamorphic wide-screen in the 4:3 VGA render window.
 - **Editor:** Shows scenes using a letter-box format during scene editing giving designers the option to set a user defined camera aspect ratio (under **Scene Settings > Rendering**). On Air and Viz Engine modes are not affected.
 - **No Video:** Shows scenes using a letter-box format as long as the video out is inactive. If video out is active scenes are shown in Anamorphic wide-screen in Viz Artist mode.
 - **Resize GUI:** Increases the render window to 16:9 format when editing 16:9 scenes. On Air and Viz Engine modes are not affected.
- **Render Method:** Sets the use of `Display Lists`, `VBO` (Vertex Buffer Object), or `Off`:
 - **Off:** Requires geometries to be redefined in each render step.
 - **Display Lists:** Buffers the geometry definition, which can then be drawn faster. The display list only needs to be updated if the geometry or its parameter changes.
 - **VBO:** Vertex Buffer Object is the default Render Method. Filling a **VBO** is faster than creating a display list, which means VBO can give a performance boost if there are several geometry changes or rebuilds in a Scene design. **VBO** is a required setting for object background loading (see **Background Loading** in the Viz Artist User Guide).

 **Note:** When rendering transparencies, the output from VBOs and Display Lists may differ slightly. Because of this, the render method falls back to Display Lists in objects with transparency properties, for compatibility reasons.

- **Extended Color Space:** Not in use.
- **Full Scene AA:** Sets the hardware Anti-aliasing (provided by the graphics card). Options are:
 - **None**
 - **4 Samples**
 - **8 Samples**
 - **16 Samples**
- **Fill Mode:**

 **Note:** If using a Matrox X.mio2 card, any adjustments to the Fill Properties have immediate effect during operation. For the X.mio2+ and X.mio3 video boards, Viz Engine needs to be restarted for the changes to take effect.

- **Direct:** Does not modify fill output.
- **Unshaped:** Brightens fill when AutoKey is enabled.
- **Shaped:** Pre-multiplies fill with key.
- **Use Fill Mode (for Post Production and NLE):**
 - **Active:** Uses Fill Mode for Post Production and NLE.
 - **Inactive:** Does not use Fill mode for Post Production and NLE.
- **RGB to YUV:** Enables color conversion either in the Shader or on the Matrox board. When alpha on the output is turned off on systems with either the Matrox X.mio3 in **Fast Texture Mode** or the Matrox DSX LE4, **RGB to YUV** must be set to Shader. In all other cases, the recommended setting is **Matrox**.
- **On Air Mouse Cursor:** Enables a mouse cursor when in On Air mode and using interactive applications. Should be disabled for Video Wall and when DVI out is enabled.

- **Execute All Animations:** Enables Viz Engine to only animate visible objects when deactivated. Default is *Active*.
- **Frame Counter:** Selects the Frame Counter type for animations. This setting takes effect for Standard-PC versions, that use NVIDIA cards and drivers:
 - **Incremental:** Increases the field counter with every field (smooth animations).
 - **OpenGL:** Tries to requests the retrace counter through OpenGL. If not possible, due to driver or hardware problems, it falls back to the Incremental mode.
 - **System:** Uses the internal CPU clock.
 - **Incremental Video Wall:** Advances animation on Viz Engines simultaneously (by incrementing the frame counter based on the elapsed time between render steps) in a Video Wall environment with multiple Viz Engines. If a Viz Engine runs slower than real-time, the next frame (or frames) is skipped to catch up with the Viz Engines running real-time.
- **Frame Speed:** Enables Viz Artist/Engine to run at a slower rate than the actual refresh rate (determined by the screen speed with the use of a g-sync card). This is relevant for Video Wall applications when the scene (e.g. interactive scenes) cannot run real-time (resource intensive), which means that all participating computers are synced to a lower speed. Running at 30Hz (screen speed 60Hz divided by two) can be acceptable, however, this affects the animation quality (animation is not as smooth).
- **Force Ringing Filter Off:** Overrides ringing filter (forces it off) when set to *Active*. Forcing ringing filter off can enhance performance at the cost of possibly introducing visual artifacts, typically bands or edges near edges. It is advisable to keep the default value.
- **Image Combining:** Sets a second texture for image combining. In a Texture Editor (see the **Texture Editor** page in the **Scene Management** section of the [Viz Artist User Guide](#)), it is possible to set a second texture which is used for the image combining. The Texture Editor offers two possible modes: The first mode uses the second image as an alpha channel, whereas the second mode defines a blend between the two textures. Configuring Image Combining to *Software* enables the combination to be calculated entirely on the CPU. Configuring Image Combining to **Multi Texturing** enables the combination to be calculated on the graphics card for combining or blending the two images. In this case, the texture creation is faster and memory is saved as well. Default is *Software*. If there are performance or memory issues, especially with scenes imported from Viz Artist/Engine 2.x, it is recommended to change this setting to *Multi Texturing*.

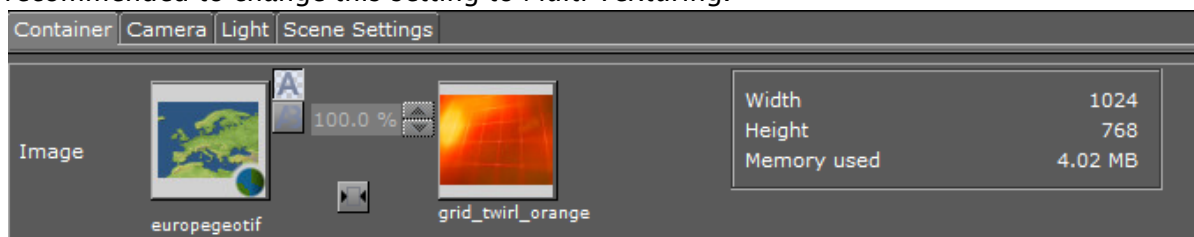

- **Key Render Mode:** Determines how the key should be rendered. This configuration is used when the Key Render Mode (see **Global Settings** in Scene Settings (see the [Viz Artist User Guide](#))) is set to **Config**:
 - **Double Pass:** Uses two rendering steps as in older 3.x versions. Double Pass should be used for old 3.x scenes for not breaking compatibility, for new scenes Single Pass should be used as it is faster.

- **Single Pass:** Uses one rendering step as in 2.8 versions. A shaped video image has its video data multiplied by its alpha component (1) while the video data of an unshaped image remains untouched (2). Shaped images are also referred to as 'pre-multiplied alpha images'.

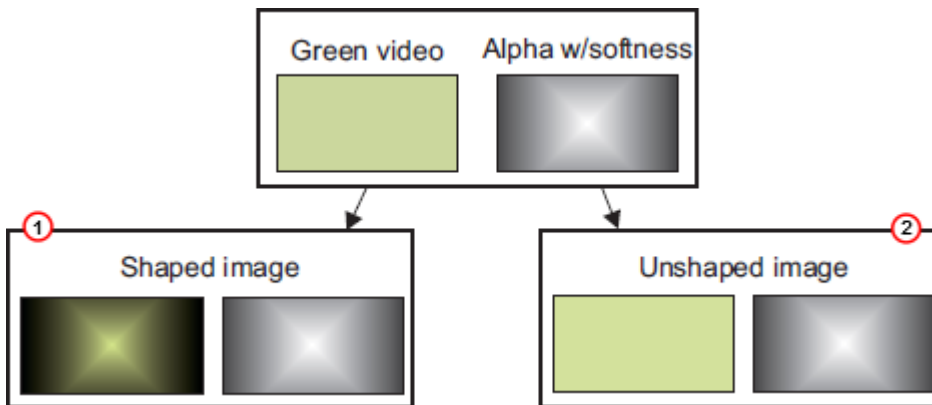

- **Sync. DirectShow:** Synchronizes DirectShow clip playback with renderer (may cause video jumps and audio cracks).
- **Image Load Error:** Configures Viz Engine to keep the old image or clear the image (i.e. not showing anything) if an image load error occurs.
- **Render Scale:** Changes the render scale when using a tracking system with lens distortion.
- **Aux Rendering:** Activates the rendering pipeline for integration with third party render engines.
- **Aux Camera:** Sets camera for auxiliary rendering pipeline.

7.23 Scene Default Values

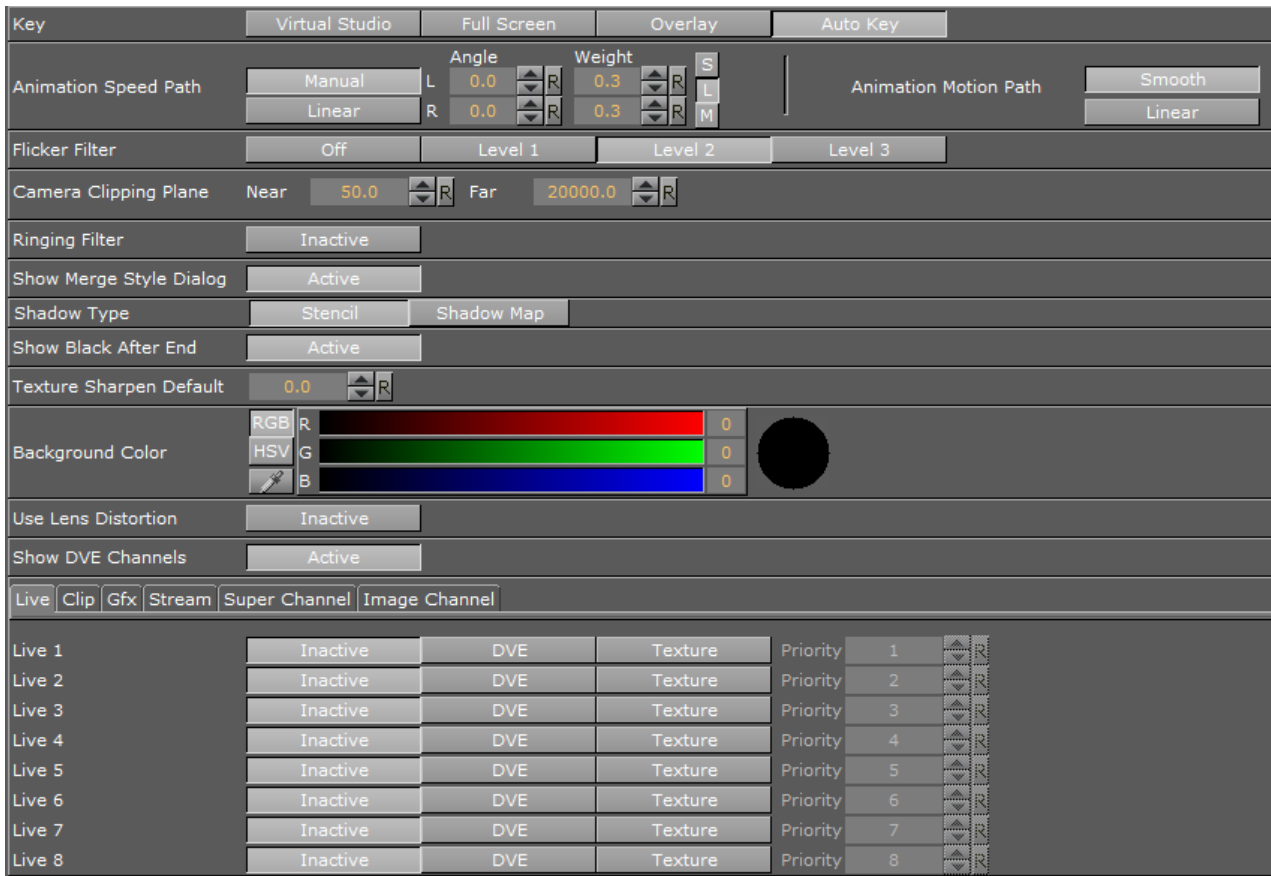

This section configures the default values for new scenes.

- **Key:** Sets the key mode. Alternatives are `Virtual Studio`, `Full Screen`, `Overlay`, and `Auto Key`.
- **Animation Speed Path:** Sets the default animation speed either to **Manual** or **Linear**, and define the default **Angle** and **Weight**.
- **Animation Motion Path:** Defines the default motion path between position key frames. When set to `Smooth`, the motion path is calculated as a Bezier curve between position key frames. Handles are added to the key frame positions in the preview window to allow for path editing. When set to `Linear` the animated object follows a straight line between position key frames. This setting can be changed individually under **Path**, in the Viz Artist Channel Editor.
- **Flicker Filter:** Reduces interlaced flicker on high contrast objects when enabled. For example small lines and hard objects. Alternatives are `Off`, and `Level 1-3`.
- **Camera Clipping Plane:** Sets the range of the virtual camera. **Near** sets the close range while **far** defines the far range. Only objects within this range are rendered.
 - **Near:** Sets the Near value to clip unwanted objects from the foreground. Default value is 50.
 - **Far:** Sets the Far value to clip unwanted objects from the background. Default value is 20000.

Note: The camera range is where the Z-buffer is within. So if Z-buffer problems arise, they may be solved by editing the camera clipping plane settings.

- **Ringing Filter:** Sets the default value for the Ringing Filter. A ringing filter reduces high frequency values in the video signal created by high contrast and color changes in horizontal directions.
- **Show Merge Style Dialog:** Enables the user, when opening a scene in Viz Artist, to open old-style merged objects and expose containers within it.
 - This feature relates to scenes using old-style ordering of containers within merged objects, and solves the problem with auto-follow. When loading such scenes the dialog lets the user decide how to deal with them.
 - Users that are aware of this and decide to keep the old style can deactivate this dialog.
- **Shadow Type:** Selects how shadows are displayed. Choose between `Stencil` and `Shadow Map`.
- **Show Black After End:** Shows black after a clip has finished playing.
- **Texture Sharpen Default:** Sets the default sharpen value for textures.
- **Background Color:** Set default scene background color.
- **Video Input Layer Targets and Priority:** Sets the defaults for how the specific input channel should be used and its priority. Available options are `Inactive`, `Texture`, `DVE` and `Priority`.
- **Use Lens Distortion:** Activates the Lens Distortion. For detailed settings, see the **Advanced Lens Distortion** page in the **Cameras** section of the [Viz Artist User Guide](#).
- **Show DVE Channels:** Shows the DVE Channels in the Scene Editor if activated.

7.23.1 Media Asset Configuration

Here you can pre-configure all available media assets to the different modes of DVE or Texture. This works for Media Assets such as **Live Video**, **Clip Channels**, and **Stream Channels**. **Super Channels** and **Image Channels** can only be pre-configured as `Inactive` or `DVE`.

Live	Clip	Gfx	Stream	Super Channel	Image Channel				
Live 1				Inactive	DVE	Texture	Priority	3	
Live 2				Inactive	DVE	Texture	Priority	6	
Live 3				Inactive	DVE	Texture	Priority	9	
Live 4				Inactive	DVE	Texture	Priority	12	
Live 5				Inactive	DVE	Texture	Priority	15	
Live 6				Inactive	DVE	Texture	Priority	18	
Live 7				Inactive	DVE	Texture	Priority	21	
Live 8				Inactive	DVE	Texture	Priority	24	

By setting the individual number and type of Media Asset to `Inactive`, `DVE` or `Texture`, the desired channel is automatically set up when dragged into the Scene Tree of new scenes. The priority option works only in DVE mode, and influences the drawing order of the defined channels.

7.24 Spaceball

The Spaceball section is used to configure a 3D navigation device.

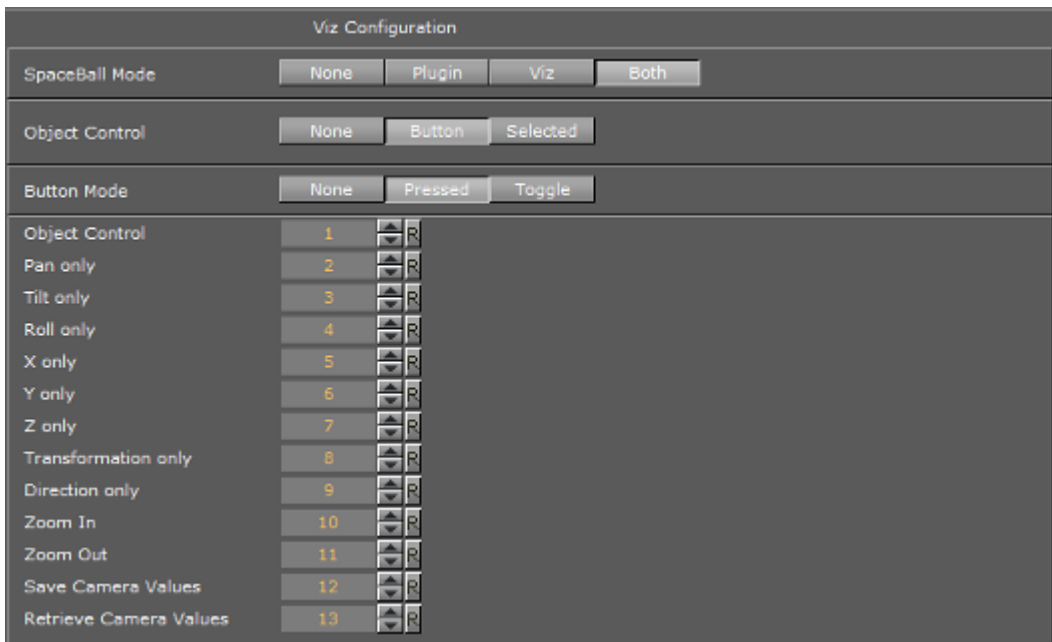

- **SpaceBall Mode:** Sets special setups where the Spaceball should only control specific plug-ins without influencing the scene (objects/camera):
 - **None:** No setup.
 - **Plugin:** Controls plug-ins.
 - **Viz:** Controls Viz Artist/Engine objects.
 - **Both:** Controls both plug-ins and Viz Artist/Engine objects.
- **Object Control:**
 - **None:** No setup.
 - **Button:** Uses button for object control.
 - **Selected:** Modifies only the selected object.
- **Button Mode:**
 - **None:** No setup.
 - **Pressed:** Triggers an action like a button in a user interface.
 - **Toggle:** Sets a state. When a button is pressed, only the dominant axis is considered in a move, whereas when the button is released all movements are applied. The numeric fields are used to map the various buttons on the 3D navigation device. This varies by the vendor and the vendors model; hence, the button numbers need to be looked up in the [Viz Artist User Guide](#) for the respective device.

Button options are:

- Object Control
- Pan Only
- Tilt Only
- Roll Only
- X Only
- Y Only
- Z Only
- Transformation Only

- Direction Only
 - Zoom In
 - Zoom Out
 - Save Camera Values
 - Retrieve Camera Values
-

7.25 User Interface

This section describes the user interface settings. Some of these settings are also available in Viz Artist.

- [Various](#)
- [Colors](#)
 - [Global Settings](#)
 - [To Change a Preset Color Theme](#)
 - [To Change a Subjects Color](#)
 - [Scene Tree](#)
 - [To Change the Amount of Active Colors](#)
 - [To Create a Color](#)
- [Shortcuts](#)

7.25.1 Various

Various	Colors	Shortcuts
Gui Icon Font	Verdana	
Gui Font Size	10 12 14 18	
Button Gradient	None Level 1 Level 2 Level 3	
Mouse Over Effect	Active	
Icon Size	Small Large	
Show "-Blur-" Fonts	Active	
Show "-Outline-" Fonts	Active	
Import Default Type	Archives	
Folder Type Highlighting	Inactive	
Auto Grab Focus	Active	
Reset Startup Default Folder	Reset	
Allow Folder Move	Normal w/Shift No	
Performance Update Interval	50 fields	
On Air Info Update Interval	0 seconds	
Tool Tips	On Delay On (ms) 300 Delay Off (ms) 10000	
Screen Layout Mode	Normal Mosaic Horizontal Mosaic Vertical Dual Screen	
Default Merge Mode	Merge to Subdirector w/Actions & Events w/A. & E. to Subd.	
Default Split Mode	Split to existing Dir.	
Default Color Space	RGB HSV	
Update Control Text	Off	
Script Middle Mouse Copy	Off	
Gui Timeout (ms)	360000	
Off Air Shortcut	Esc Shift+F1	

- **GUI Icon Font:** Sets the Font type for all icons of items such as scenes, objects, materials, images, fonts, and audio clips. Complex character sets such as Arabic, Hebrew and Chinese must change the default font type to show the correct names for the icons.
- **GUI Font Size:** Sets a global font size for the Viz Artist user interface. Alternatives are 10, 12, 14, 18 pixels.
- **Button Gradient:** Sets the gradient level of the buttons in the Viz Artist user interface.
- **Mouse Over Effect:** Provides mouse over effect for buttons in the Viz Artist user interface. Set to Active or Inactive.
- **Icon Size:** Sets a size preference for scene, font and audio icons. Icon size can also be switched using the context menu in the server view in Viz Artist; however, changing this setting in Viz Artist is not saved as a preference for later sessions.
- **Show "Blur" fonts:** Sets the default show or hide blur fonts in the Server area. The option can then be toggled with the **Item Context Menu** (see the [Viz Artist User Guide](#)).

- **Show “Outline” fonts:** Sets the default for showing or hiding the outline fonts in the Server area. The option can then be toggled with the **Item Context Menu** (see the [Viz Artist User Guide](#)).
- **Import Default Type:** Selects the default item type for imports, which is pre-selected in the GUI **Import Menu**. Options are:
 - **Fonts**
 - **Images**
 - **Geometries**
 - **Scenes**
 - **Audio**
 - **Archives**
- **Folder Type Highlighting:** Highlights the folders that contain content matching the current Viz Artist Server View (for example Scene, Geometry, Material, Image, Font, Audio, etc.) when enabled.

 **Note:** This can cause some performance overhead, when switching to different types and/or with opening sub folders (but only first time, as the information is cached).

- **Auto Grab Focus:** Grabs focus once a widget is moused over when set to *Active*. When *Inactive*, a middle mouse click grabs the focus, as a left and right-click do.
- **Reset Startup Default Folder:** Resets the startup folder. If Viz Artist is unable to start due to problems with the last saved server view, clicking the **Reset** button resets the Server view to its top node.
- **Allow Folder Move:** Allows or restricts the user’s ability to move/organize projects and folders in a Graphic Hub. Options:
 - **Normal:** Drag folders freely, as required to move (Default setting).
 - **w/Shift:** Press **SHIFT** and drag to move folder or folders.
 - **No:** No folder movement allowed.
- **Performance Update Interval:** Sets how often Viz Engine should update the Performance Bar when it is opened.
- **On Air Info Update Interval:** Sets the update interval for the [On Air Information Panel](#) window. Note that a shorter interval decreases render performance. Setting to 0 means that no update occurs.
- **Tooltips:** Enables or disables the tooltip information in the Viz Artist user interface.
 - **Delay On (ms):** Sets the amount of time in milliseconds before the tool tip shows. Default is 1500 ms.
 - **Delay Off (ms):** Sets the amount of time before the tool tip disappears. Default is 4000 ms.
- **Screen Layout Mode:** Set to either:

- **Normal:** Default screen (single monitor):

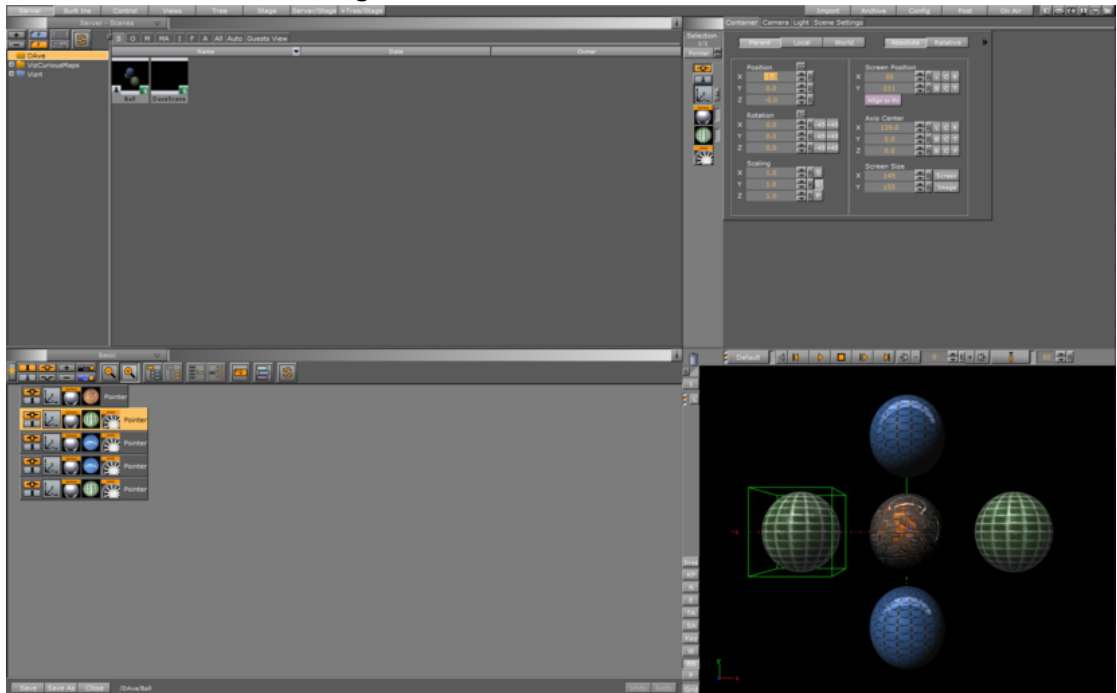

- **Mosaic Horizontal:** Viz Artist shows on the left monitor and the Scene Editor shows on the right monitor (two monitors):

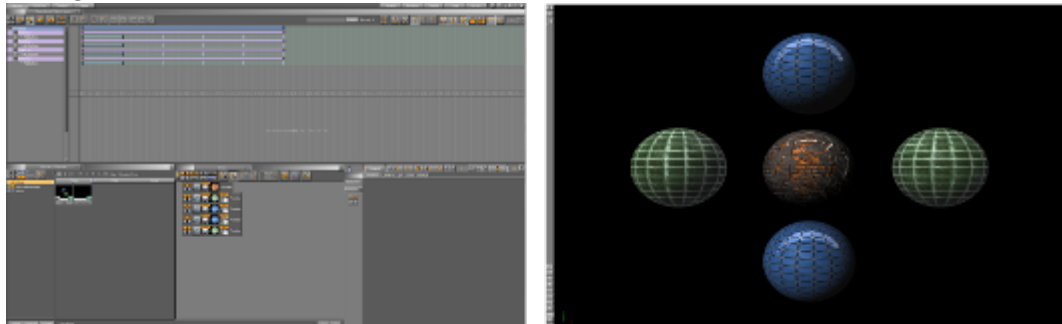

- **Mosaic Vertical:** Viz Artist shows on the top monitor and the Scene Editor shows on the bottom monitor (two monitors):

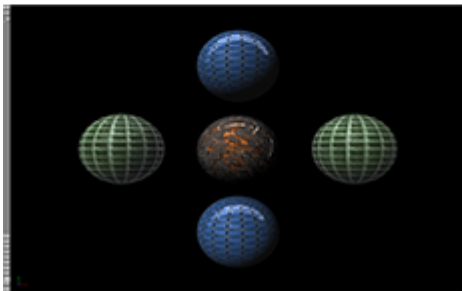
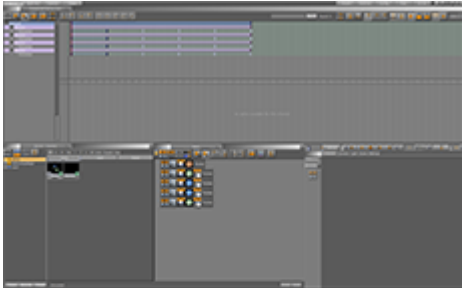

Note: Mosaic Horizontal and Mosaic Vertical are only available with NVIDIA graphics cards, on systems running at least Windows 7. Open the NVIDIA properties to setup Mosaic before changing the Viz Config file.

- **Dual:** The Scene Editor opens in a new window (two monitors):

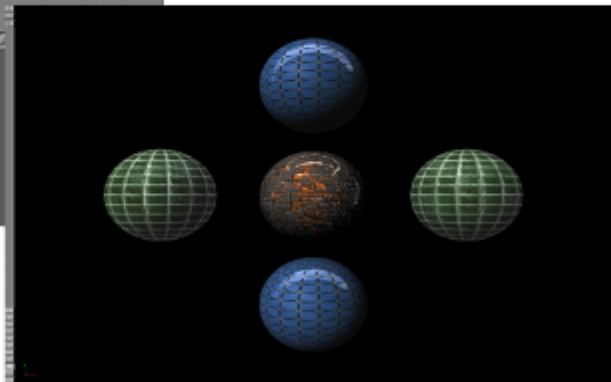
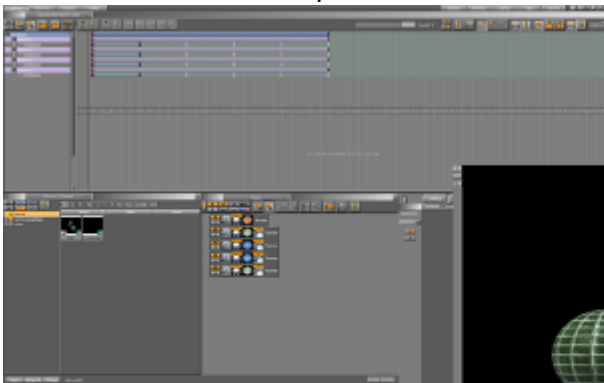

- **Default Merge Mode:** Sets the default merge behavior available in the Viz Artist user interface. Options are:
 - Merge
 - [Merge] to sub director
 - [Merge] w/actions & events
 - [Merge] w/actions and events to sub director (*w/A. & E. to Subd.*)

- **Default Split Mode:** Sets the default split behavior available in the Viz Artist user interface. Options are:
 - Split
 - [Split] to existing director
- **Default Color Space:** Selects RGB or HSV as the default color space for the Material editor
- **Update Control Text:** Makes Update Control Text active or inactive:
 - **Active:** Updates the Control text in Control Objects with every key stroke.
 - **Inactive:** Does not update the Control text in Control Objects with every key stroke.
- **Script Middle Mouse Copy:** Enables or disables the middle mouse button copy and paste function in the Script Editor.
- **Gui Timeout (ms):** Defines the timeout threshold in milliseconds when awaiting command replies from the Engine. After the specified time, a timeout dialog is displayed. The minimum and default value 180000, or 180 seconds.
- **Off Air Shortcut:** Selects the shortcut that takes the render On Air window to Off Air.

✓ **Tip:** Adjust the timeout value if timeouts occur when loading very large scenes in Viz Artist.

7.25.2 Colors

The Colors tab gives the ability to change the User Interface color theme.

Global Settings

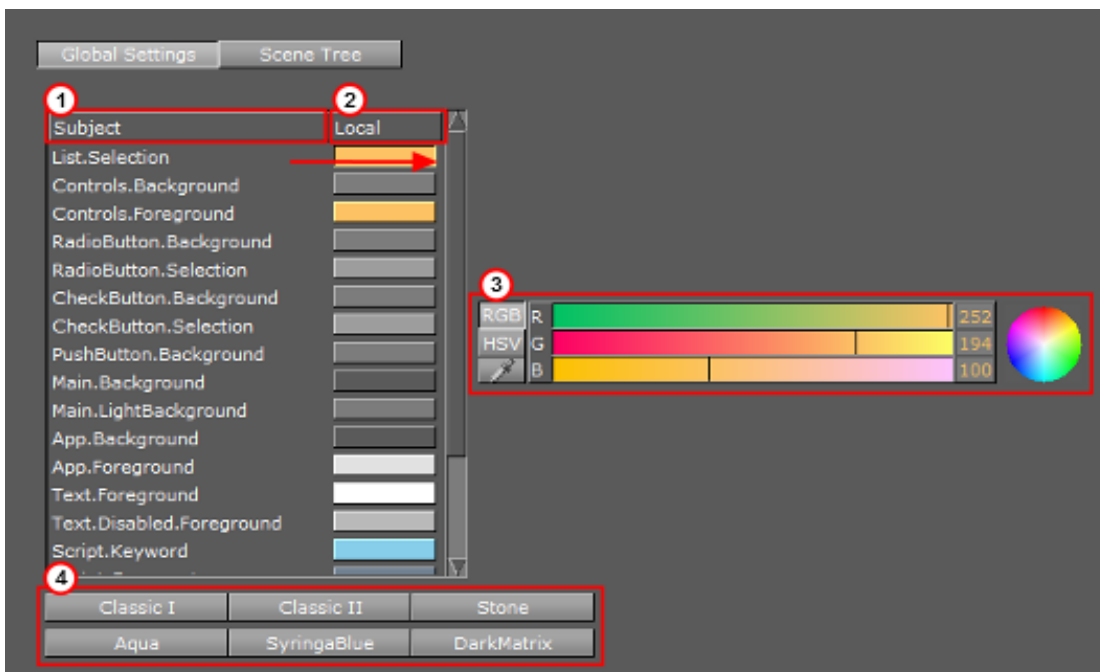

Use Global Settings to change the color theme of the User Interface. All the changes made to the User Interface are local. Click **Save** then restart Viz Artist for the changes to take effect.

There are six pre-set color themes (4):

- Classic I
- Classic II
- Stone (default)
- Aqua
- SyringaBlue
- DarkMatrix

To Change a Preset Color Theme

Click on a preset color theme (4). Individual parts of the User Interface can be assigned a new color, if the part is listed in the Subject panel (1).

To Change a Subjects Color

1. Click on a Subjects color bar in the Local panel (2).
2. In the color selection area (3) select **RGB** or **HSV**.
3. In the color selection area, click a color bar, or the color circle, and drag to change the color.
or
1. Drag one of the current Subjects color (in the Local field).
2. Drop it onto another Subjects Local field.
or
1. Click on the eye dropper icon in the color bar.
2. Move the cursor to an area, color on-screen.
3. Click to accept the new color.

Scene Tree

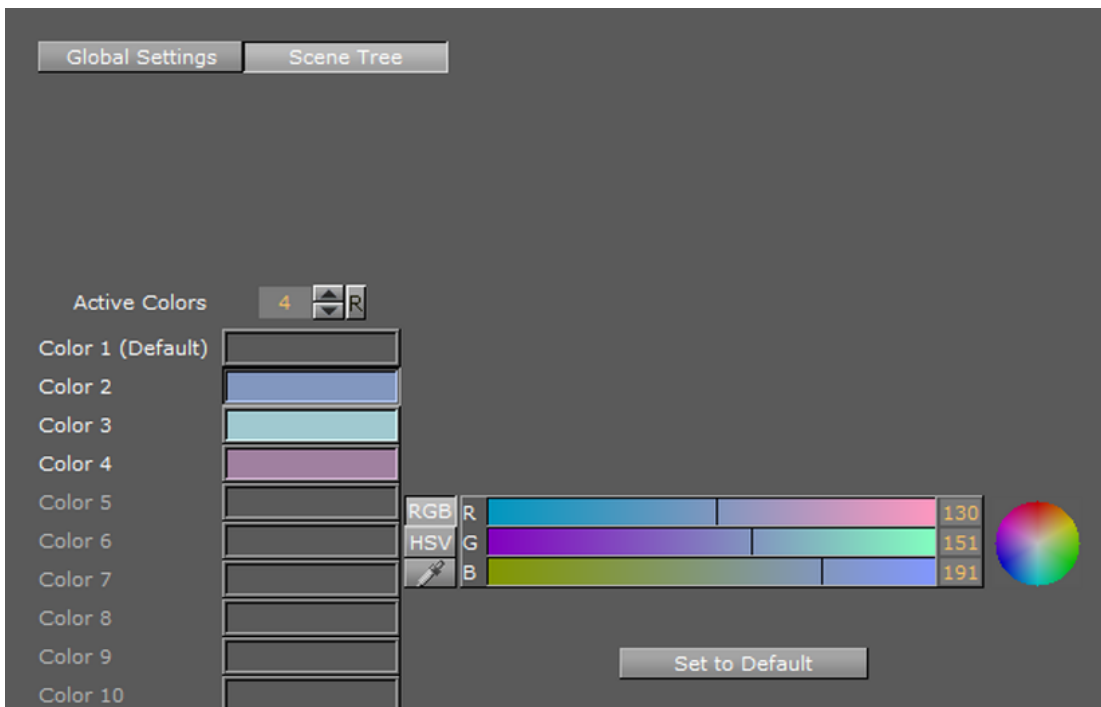

Use the Scene Tree panel to set the color codes for Containers in the Scene Tree. A Container with a color code can be searched for in the Scene Tree, and the Scene Tree can be restricted to Containers with certain colors (see **Scene Tree Menu** in the [Viz Artist User Guide](#)).

A text tag can also be added to the color. The text is Scene specific and saved with the Scene on the Graphic Hub. Note that the colors might change if the Scene is opened on a different machine with a different color setting.

Example: All text Containers can be colored gray and tagged Text, while all Containers that hold images can be colored green and tagged Image, and so on.

Four colors are configured and active by default with no text descriptions. Click **Set to Default** to set all color bars to their default setting. The color options are available in the GUI **Scene Settings** panel in the Tree Color Text setting, and available for use in the Scene Tree panel.

To Change the Amount of Active Colors

In the **Active Colors** field enter the amount of colors to be active. Up to 16 colors can be configured and made active.

To Create a Color

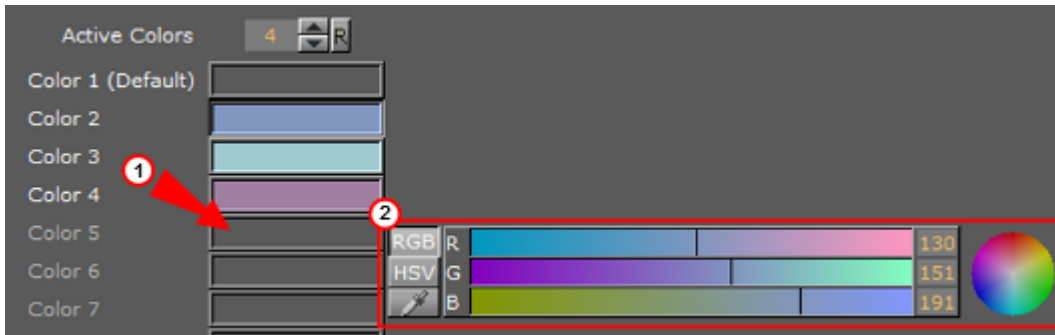

1. Click on a unused color bar (1). It is also possible to change the color of the first four colors. Click in their color bar.
2. In the color selection area (2) select **RGB** or **HSV**.
3. In the color selection area, click a color bar, or the color circle, and drag to change the color.
4. If required: Click the color bar (1) and enter a name for it.
or
 1. Click on the eye dropper icon in the color field.
 2. Move the cursor to an area, color on-screen.
 3. Click to accept the new color.

7.25.3 Shortcuts

The shortcuts view shows all available server, scene tree and property actions and the currently assigned shortcuts. All shortcut configurations are saved to the database into the user table for personalization.

Action	Shortcut	Shortcuts
Check In Files	Ctrl-i	
Check Out Files	Ctrl-o	
Copy File	Ctrl-g	
Copy Path to Clipboard	Ctrl-Shift-u	
Copy Uuid to Clipboard	Ctrl-u	
Create File	Ctrl-a	
Cut File	Ctrl-x	
Export File	Ctrl-e	
Open Search View	Ctrl-f	
Paste-Duplicate File	Ctrl-Shift-v	

- **Server, Scene Tree and Properties:** Shows all server actions and their currently assigned shortcuts.
- **Shortcuts:** Shows a list of available shortcut key-combinations that can be assigned to the selected action when clicked.
- **Reset All:** Resets all shortcuts to the default setup.

7.26 Video Board

This section is used to configure video input, output and clip playback related settings.

Note: Not available on VGA versions of Viz Engine.

7.26.1 Video Board Properties

Loophthrough Delay (EE)	<input type="text" value="2"/> Rframes
Videoout Ring Buffer	<input type="checkbox"/> On
Ring Buffer Size	<input type="text" value="5"/> Rframes
Use Watchdog	<input type="checkbox"/> Off
Watchdog Timeout	<input type="text" value="999"/>
Watchdog Mode	<input type="radio"/> First Geom Load <input type="radio"/> At Startup <input type="radio"/> First Geom Load/DVE
Watchdog Reactivation	<input type="checkbox"/> Off
Use GPU Direct	<input type="checkbox"/> Off
Check Video Card	<input type="radio"/> Matrox <input type="radio"/> Xmio2Plus <input type="radio"/> Epoch <input type="radio"/> Aja <input type="radio"/> X.mio3/DSX LE4 <input type="radio"/> User Defined
Software I/O Mode	<input type="radio"/> SHM Channels <input type="radio"/> Live Engine Integration <input type="radio"/> NewTek TriCaster <input type="radio"/> No video I/O (VGA)
Zero Frame Delay Mixer	<input type="checkbox"/> Off

- **Loophthrough Delay (EE):** Sets the delay for live video input (DVS, Bluefish and NVIDIA SDI boards only). This setting applies for all input channels. For Matrox, see Video Delay DVE in Video Properties.
- **Videoout Ring Buffer:** Sets the render buffer for video output. Helps to prevent frame drops on the video output during execution of commands or loading of objects. When enabled, the engine renders a number of graphics frames in advance and provide it to the video hardware. The number of frames rendered forwardly is defined by the ringbuffer Size. Large buffer sizes delay the output and increase the input to output delay for video textures.
- **Ring Buffer size:** Sets the size of the ringbuffer in frames.
- **Use Watchdog:** Toggles Watchdog on or off:
 - **Matrox:** See [Matrox Watchdog Configuration](#).
 - **Bluefish:** See [Special Configuration Options for Bluefish444](#) in the [BlueFish444](#) chapter.
- **Watchdog Timeout:** Sets the time, in milliseconds, until the watchdog takes over control. This value should not be smaller than the time of two fields/frames. Default value is 999 ms.
- **Watchdog Mode:** Sets the Watchdog mode:
 - **First Geom Load:** Activates Video Out when the first geometry is loaded.
 - **At Startup:** Activates Video Out at startup.
 - **First Geom Load/DVE:** Activates Video Out when the first geometry is loaded or an input or clip channel is set to DVE.
- **Watchdog Reactivation:** Activates the watchdog again if scenes are unloaded from renderer when set to On.

- **Use GPU Direct:** Enables a fast, low latency method to copy frames from the video IO device to the GPU and back (gives more time for the renderer to process complex and GPU intense visual effects) when set to On.
- **Check Video Card:** Selects which video cards to search for and use when Viz Artist/Engine is started. If a video card is not selected it is not used, even if it is installed in the system. All cards are enabled by default.

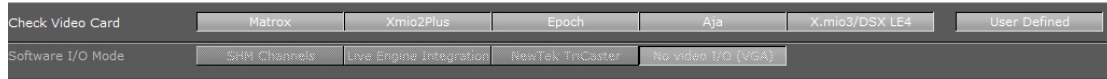

- **Select Individual Cards:** Selects/deselects video cards if **User Defined** is selected. Click on each listed card to select or deselect, as required.

Note: If a Matrox X.mio3 card is installed in the system and X.mio3/DSX LE4 is disabled, the card is treated like a Matrox X.mio2 Plus card.

- **User Defined:** Selects and uses individual cards.
- **None:** Makes all all connected video cards unavailable for Viz Engine and Viz Artist when selected. This can be used to run a Viz Artist video version as a VGA version, even if video cards are installed. Possible use-cases for this are:
 - Dual channel Viz Trio One Boxes, which have three Viz Artist/Engine instances running and where only the first two should use the video board. The third Engine instance is exclusively for Trio preview.
 - With TriCaster implementation, where Viz Artist must run as a video version, running as VGA.
 - If utilizing the **Stryme integration** capabilities of Viz Engine, where Viz Engine hooks on to **Stryme GenesiX** to allow Stryme to show Vizrt graphics on its output. Please refer to the procedure below for further information on Stryme Integration.
- **Software I/O Mode:** Sets a specific Video I/O mode for setups without video hardware or configurations where **Check Video Card** is set to None. Not available in the VGA version.

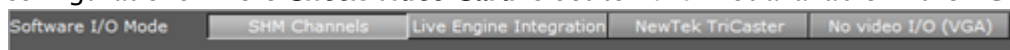

- **SHM Channels:** Sets I/O mode for third party software, utilizing the Viz SHMLib software library.
- **Live Engine Integration:** Toggles optimized I/O mode for Live Engine Integration with Viz Libero. Refer to the Viz Libero documentation for further details.
- **NewTek TriCaster:** Uses the NewTek TriCaster input and outputs. Read more about using TriCaster with Viz Engine and Artist in the Third Party Applications and Files chapter of the [Viz Artist User Guide](#).
- **No video I/O (VGA):** Disables all video version features, emulating the VGA version of Viz Engine.
- **Zero Frame Delay Mixer:** Gives the shortest input to output delay with graphics on top, when set to On. For this to work correctly, specific values for H-/V- phase must be set. For the input/output configuration, input A is bound to output A, and Input B is bound to Output B. Please observe that the input resolution must match the output resolution. If running a Dual Channel setup, make sure that input A and input B are 100% in sync and using the same resolution.

H-/V- Phase Values for Zero Frame Delay Mixer

For Matrox X.mio2, DSX.LE2 and DSX.LE3 video boards:

- **PAL:** Leaves the values at the default.
- **NTSC:** Leaves the values at the default.
- **720p50:** Valid H-Phase range from -900 to -1300.
- **720p59.94:** Valid H-Phase range from -600 to -1000.
- **1080i25:** Valid H-Phase range from -1600 to -2000.
- **1080i29.97:** Valid H-Phase range from -1100 to -1600.

To Enable Stryme Integration

To enable integration with Stryme, the Viz configuration file needs to be manually edited. Please make sure to create a backup copy of the configuration file before making any changes.

1. Locate and open the Viz configuration file.
2. Locate the section `SECTION CHANNELS_CONFIG`.
3. Add the following lines:

```
StrymeOut.Enable = 1 StrymeOut.RingbufferSize = 10 StrymeOut.SHMname =
Global\Genesis.MediaEngine.Matrox.SharedMem.0
```

- **StrymeOut.Enable:** Enables or disables the Stryme integration capabilities of Viz Engine. If the Stryme Integration is no longer needed at a later time, it can easily be disabled by changing the value of `StrymeOut.Enable` to 0.
- **StrymeOut.RingbufferSize:** Defines the size of the ringbuffer, and can be omitted. If omitted, the default value is 10. Valid values are in the range of 1-100.
- **StrymeOut.SHMname:** Defines the name of the Shared Memory name as defined by Stryme GenesisX, and can be omitted. If omitted, it defaults to `Global\Genesis.MediaEngine.Matrox.SharedMem.0`.

IMPORTANT! Stryme integration works **only** with Viz Engine in VGA mode or with **Check Video Card** set to **None** (see above).

7.27 Video Input

Video input channels are enabled or disabled with this panel. To be able to use a Live input channel, Clip channel or Stream channel, the channel must first be set to active.

- [Live and Clip Channels](#)
- [Stream Channels](#)
- [No Onboard Video Board](#)

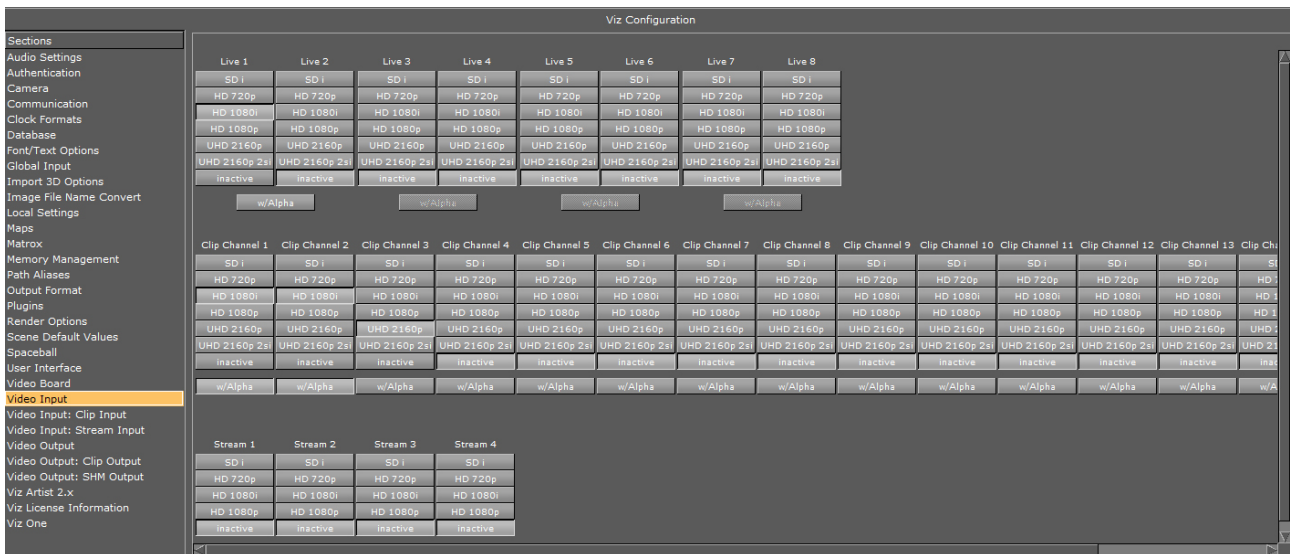

Note: The *frequency* of the channels is defined in the [Output Format](#) section.

7.27.1 Live and Clip Channels

This panel is used for activating the Live input and Clip channels and contains definitions of the video standard to which the channel is configured. It is possible to mix video standards, for example, a Viz Engine configured to playout 1080i50 can have *inputs* configured to SD.

UHD: When configuring for example, Live 1 to UHD, then Inputs 2, 3 and 4 are *disabled*. This is explained in the section [Matrox](#) in the Video Out Properties.

- **Live w/Alpha:** Combines the two (Live 1 and Live 2) input channels to one channel carrying fill and key. This means that the Y (luminance) from Live 2 in YUV is used as the key signal.
- **Clip Channel w/Alpha:** Requires key information or a key clip for clip channel when enabled. The key clip must have the string “_key” appended to the filename. For example, a clip named *i422_50M.avi* must be named *i422_50M_key.avi*.

Note: Video input format may be limited by hardware capabilities of the video board.

7.27.2 Stream Channels

The Stream channels are for live video streams (see [Video Playout From a Video Stream](#) in the [Viz Artist User Guide](#)). Set each Stream to *active* or *inactive*.

7.27.3 No Onboard Video Board

Sections				
Audio Settings				
Authentication				
Camera				
Communication				
Clock Formats				
Database				
Font/Text Options				
Global Input				
Import 3D Options				
Image File Name Convert				
Local Settings				
Maps				
Matrox				
Memory Management				
Path Aliases				
Output Format				
Plugins				
Render Options				
Scene Default Values				
Spaceball				
User Interface				
Video Board				
Video Input				
Video Input: Clip Input				
Video Input: Stream Input				
Video Output				
Video Output: Clip Output				
Video Output: SHM Output				
Viz Artist 2.x				
Viz License Information				
Viz One				

Live 1	Live 2	Live 3	Live 4
SD i	SD i	SD i	SD i
HD 720p	HD 720p	HD 720p	HD 720p
HD 1080i	HD 1080i	HD 1080i	HD 1080i
HD 1080p	HD 1080p	HD 1080p	HD 1080p
UHD 2160p	UHD 2160p	UHD 2160p	UHD 2160p
UHD 2160p 2si	UHD 2160p 2si	UHD 2160p 2si	UHD 2160p 2si
inactive	inactive	inactive	inactive

Clip Channel 1	Clip Channel 2	Clip Channel 3	Clip Channel 4
SD i	SD i	SD i	SD i
HD 720p	HD 720p	HD 720p	HD 720p
HD 1080i	HD 1080i	HD 1080i	HD 1080i
HD 1080p	HD 1080p	HD 1080p	HD 1080p
UHD 2160p	UHD 2160p	UHD 2160p	UHD 2160p
UHD 2160p 2si	UHD 2160p 2si	UHD 2160p 2si	UHD 2160p 2si
inactive	inactive	inactive	inactive

Stream 1	Stream 2	Stream 3	Stream 4
SD i	SD i	SD i	SD i
HD 720p	HD 720p	HD 720p	HD 720p
HD 1080i	HD 1080i	HD 1080i	HD 1080i
HD 1080p	HD 1080p	HD 1080p	HD 1080p
inactive	inactive	inactive	inactive

When there is no installed video board (standard-PC), the video input section no longer shows the Alpha options for Live and Clip. Video input for standard-PC versions enable clip playback by using settings in the **Properties** panel.

7.28 Video Input: Clip Input



Use the Video Input: Clip Input panel to configure available playback channels. The number of available clip input channels is set in [Video Input](#).

7.28.1 Clip Input Properties

- **Pipeline Size:** Defines the number of frames Matrox' internal clip reader buffer should buffer in advance. Default value is 20.
- **Texturemanager Size:** Sets texture download buffer size.
- **Video Delay DVE:** Sets DVE Delay of video when used as DVE.
- **Video Delay Texture:** Sets texture Delay of video when used as Texture.
- **VBI:** Defines whether VBI should be used for this channel. Set to Active or Inactive. Default mode is Inactive.

- **Delay DVE:** Sets the number of frames VBI should be delayed, before the clip can be used, in DVE mode. Default value is 0 (Off).
- **Delay Texture:** Sets the number of frames VBI should be delayed, before the clip can be used, in texture mode. Default value is 1.
- **Audio:** Enables/disables audio for this channel. When set to *Inactive*, audio is disabled. Default value is *Active*.
- **Delay DVE:** Sets the number of frames the audio clip should be delayed in DVE mode before it can be mixed to the output. Default value is 4.
- **Delay Texture:** Sets the number of frames the audio clip should be delayed in texture mode before it can be mixed to the output. Default value is 4.
- **Contains Alpha:** Enables/disables playback of clips with alpha.
- **Upscale Luma:** Enables/disables the default for upscale luma. Per scene setting of this value is set per clip channel under Scene Settings and Video clip options.
- **Shaped:** Defines whether the fill from this channel, when the channel is used in DVE mode, should be interpreted as shaped video during DVE compositing. Default value is *Inactive*.
- **Repeat Mode:** Determines the behavior of the video input in case of capture drops. Options are:
 - **None:** Does not repeat. Input goes black.
 - **Field:** Repeats the last field.
 - **Frame:** Repeats the last frame.
- **Loop Mode:** Enables/disables default for loop mode. Per scene setting of this value is set per clip channel under Scene Settings and Video clip options.
- **Reverse Fields:** Swaps fields when playing interlaced clips with negative playback speed (default setting). Per scene setting of this value is set per clip channel under Scene Settings and Video clip options.
- **Pending Enable:** Enables/disables pending clip player for this channel. The pending clip player allows clip loading of another clip while the clip channel is still using the current clip.
- **Mode on Load Error:** Determines the behavior of the current clip when loading of the pending clip fails. Options are:
 - **None:** Current clip mode is not changed.
 - **Stop:** Performs a Stop command on the current clip.
 - **Pause:** Current clip enters pause mode.
 - **Flush:** Unloads the current clip.
- **Proxy:** Allows playing video clips of a resolution different to the current configured resolution when set to *Active*. If set to *Inactive*, a video clip of a different resolution cannot be played.
- **Reactivation Delay:** Sets the minimum number of frames the texture contains black after the channel was activated to texture.
- **Ringbuffer:** Enables the input ringbuffer when played with an NVIDIA SDI output when set to *Active*.

See Also

- [Matrox](#)

7.29 Video Input: Stream Input

Use the Video Input: Stream Input Panel to configure available IP stream input channels. The number of available IP Stream input channels is set in [Video Input](#).

7.29.1 Stream Input Properties

Map to Viz Channel Stream1 ▾

ProcAmp

Brightness 0 ▾ ▹ ▸ ▹ ▸ ▹ ▸

Lumagain 0 ▾ ▹ ▸ ▹ ▸ ▹ ▸

Hue 0 ▾ ▹ ▸ ▹ ▸ ▹ ▸

Saturation 0 ▾ ▹ ▸ ▹ ▸ ▹ ▸

Allow Super Black Active

Allow Super White Active

Allow Chroma Clipping Inactive

Key

Contains Alpha Inactive

Key Apply Offset Inactive

Key Upscale Luma Active

Key Invert Luma Inactive

Shaped Inactive

Video

Manager Size 0 ▾ ▹ ▸ ▹ ▸ ▹ ▸

Streaming Size 0 ▾ ▹ ▸ ▹ ▸ ▹ ▸

Pipeline Size 8 ▾ ▹ ▸ ▹ ▸ ▹ ▸

Texturemanager Size 8 ▾ ▹ ▸ ▹ ▸ ▹ ▸

Video Delay DVE 1 ▾ ▹ ▸ ▹ ▸ ▹ ▸

Video Delay Texture 1 ▾ ▹ ▸ ▹ ▸ ▹ ▸

Repeat Mode Field ▾

3G Level B Inactive

VBI

VBI Inactive

Delay DVE 0 ▾ ▹ ▸ ▹ ▸ ▹ ▸

Delay Texture 0 ▾ ▹ ▸ ▹ ▸ ▹ ▸

Audio

Audio Active

Channels 2_channels ▾

Delay DVE 1 ▾ ▹ ▸ ▹ ▸ ▹ ▸

Delay Texture 1 ▾ ▹ ▸ ▹ ▸ ▹ ▸

- **Map to VizChannel:** Sets which video in channel is mapped onto this Matrox video in channel. The drop-down gives a choice between the available channels. Only the channels not already taken are shown.
 - **Unused:** Do not use this Matrox channel for video input
 - **Video <1 to 8>:** Captures input and makes it available in *Video1*.
- **ProcAmp Properties**
 - **Brightness:** Sets the relative offset on the luminance component of the incoming video (min./max. values are dynamic and determined by the hardware). Default value is 0 (Off).
 - **Lumagain:** Sets the gain on the luminance component of the incoming video (min./max. values are dynamic and determined by the hardware). Default value is 0 (Off).
 - **Hue:** Sets the color shift on the chrominance component of the incoming video (min./max. values are dynamic and determined by the hardware). Default value is 0 (Off).
 - **Saturation:** Sets the gain on the chrominance component of the incoming video (min./max. values are dynamic and determined by the hardware). Default value is 1 (On).
- **Fill Properties**
 - **Allow Super Black:** Determines whether or not to clip an output video signal that is under 7.5 IRE units. Default mode is *Inactive*.
 - **Allow Super White:** Determines whether or not to clip an output video signal that is over 100 IRE units. Default mode is *Inactive*. The colorimetry tables for SD (ITUR-BT 601) and HD (ITUR-BT 709) define a color conversion from YUV with the range of 16-235 to RGB with the range of 0-255. Values above 235 are Super White and values below 16 are Super Black. As Super White and Super Black pixels are outside the range of 1-byte RGB, these pixels are clamped to the normal 16-235 YUV range when used in a texture.
 - **Allow Chroma Clipping:** Determines whether or not to clip over-saturated chroma levels in the active portion of the output video signal. Default mode is *Inactive*.
- **Key**
 - **Contains Alpha:** Enables/disables playback of clips with alpha.
 - **Key Apply Offset:**
 - **Key Upscale Luma:**
 - **Key Invert Luma:**
 - **Shaped:** Defines whether the fill from this channel, when the channel is used in DVE mode, should be interpreted as shaped video during DVE compositing. Default value is *Inactive*.
- **Video**
 - **Manager Size:**
 - **Streaming Size:**
 - **Pipeline Size:** Defines the size of the input queue. Default value is 8.
 - **Texturemanager size:** Sets Pre-allocated texture buffer size, in frames.
 - **Video Delay DVE:** Sets DVE video delay when used as DVE.
 - **Video Delay Texture:** Sets texture video delay when used as Texture.
 - **Repeat Mode:** Determines the behavior of the IP stream input in case of capture drops. Options:

- **None:** Does not repeat. Input goes black.
 - **Field:** Repeats the last field.
- **3G Level B:** Activates Level B for 3G mode in 1080p50/60/60M. Default mode is Level A.
- **VBI**
 - **VBI:** Defines whether VBI should be used for this channel. Default mode is Inactive.
 - **Start Line:** Defines at which line on the input the VBI section starts. Default value is 0 (off). The minimum VBI values are (as for VideoOut):
 - **NTSC:** 7
 - **PAL:** 6
 - **720p:** 7
 - **1080i:** 6
 - **Delay DVE:** Sets the number of frames VBI should be delayed, before the IP stream can be used, in DVE mode. Default value is 0 (off).
 - **Delay Texture:** Sets the number of frames VBI should be delayed, before the IP stream can be used, in texture mode. Default value is 1.
- **Audio**
 - **Audio:** When activated, this setting enables audio for this channel. When inactive, audio is disabled. Default value is Activate.
 - **Channels:** Sets the number of audio channels to capture (see also Audio in Viz). Default number of channels are 2. Available channel options for AES on X.mio are: None, 1, 2, and 4. For AES on X.mio2/X.mio2 Plus and for Embedded the channel options are: None, 1, 2, 4, 8, and 16.
 - **Delay DVE:** Sets the number of frames the audio clip should be delayed in DVE mode before it can be mixed to the output. Default value is 4.
 - **Delay Texture:** Sets the number of frames the audio clip should be delayed in texture mode before it can be mixed to the output. Default value is 4.

Shared Memory

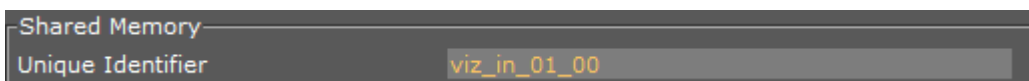

- **Unique Identifier:** Changes the name of the Shared Memory. Not available on systems with [Matrox X.mio3 IP / DSX LE 4 IP](#) video boards.

7.29.2 MPEG-TS over RTP / UDP and RTPS Streaming

Viz Engine can send and receive MPEG-TS over RTP/UDP/RTPS streams by using DSX.Core or any Matrox board that has an RTP upgrade.

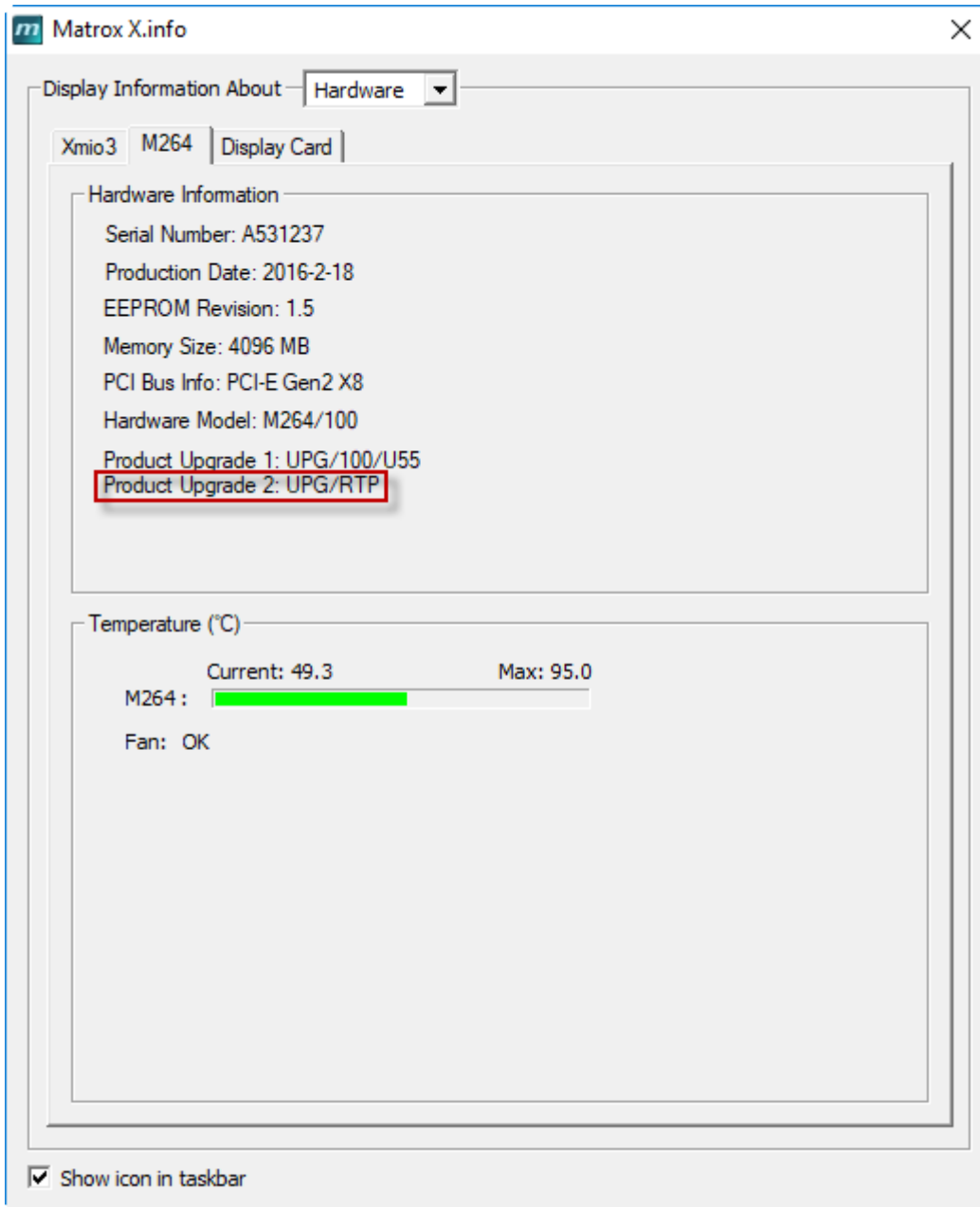

⚠ Note: MPEG-TS over RTP/UDP and RTPS streaming require a Mezzanine IP license! For output only progressive formats are supported. For input both progressive and interlace formats are supported.

Capabilities Overview

Features	Input	Output
Progressive	✓	✓

Features	Input	Output
Interlaced	✓	✗
MPEG-TS over RTP	✓	✓
MPEG-TS over UDP	✓	✗
RTSP	✓	✗
RTMP	✗	✗

⚠ Note: Only H264 video and AAC audio are supported. Moreover only audio with two channels are supported. AV synchronization is disabled by default in the configuration and should only be enabled if the signal has an audio.

Output mode:

There are two different output modes: SDI or RTP. To enable output to SDI, a Matrox board supporting SDI is needed and must be chosen in the configuration file: `Matrox.Devices = A520888`.

If the SDI board does not support an RTP upgrade, another board must be installed; however, this board does not need to be included in the configuration.

If RTP output is needed, an M.264 is needed and must be chosen in the configuration file.

Receiving MPEG-TS over RTP / UDP and RTSP Streams

MPEG-TS over RTP

The following configuration needs to be set to configure for MPEG-TS over RTP Stream Input:

- `GPUDirect` should be turned off.
- `use_compositor` should be 0.
- An NTP server must be set (e.g. 131.107.13.100).
- The color conversion `rgb_2_yuv` should be set to `shader (=1)`.
- The stream input should be set (e.g. `720P_5000_SMPTE296`).
- The `StreamIn1.SrcUdpPort` needs to be set to an even port number (e.g. 20000).

ⓘ Info: The port number should always be even.

- `StreamIn1.SrcAddress` is a string in the following format: `[protocol]://[address]:[port]/[location]`
 - **[protocol]:** RTSP, UDP or RTP.
 - **[address]:** The sender's IP number.
 - **[port]:** The sender's port number.
 - **[location]:** Where the stream is located (optional).

- *StreamIn1.NICAddress* is the IP address of your local network interface card that is going to receive the stream.

To simulate a 720p MPEG-TS over RTP stream to 10.211.1.26, you can use ffmpeg with the following parameters:

```
ffmpeg.exe -f lavfi -re -i smptehdbars=s=1280x720:r=50[out0] -c:v libx264 -profile:v high422 -pix_fmt yuv422p -x264-params "nal-hrd=cbr" -b:v 20M -minrate 10M -maxrate 10M -bufsize 10M -c:a aac -ac 2 -f rtp_mpegts -bsf:v h264_mp4toannexb rtp://10.211.1.26:20000
```

This generates a test pattern in 720p and sends it to 10.211.1.26 on port 20000.

RTSP

To receive the stream *StreamIn1.SrcAddress* value should be *rtp://10.211.1.26:20000*.

VLC can be used to generate RTSP stream for testing purposes:

1. **Media > Stream...** (CTRL + S).
2. Choose a valid file as source.
3. Click on **Stream**.
4. Click on **Next**.
5. Select **RTSP as New destination**.
6. Click **Add**.
7. Choose a port. For instance, 8554.
8. Choose a path name. For instance, *test*.
9. Choose profile. H.264 + MP3 (TS). Disable audio, as MP3 is not supported.
10. Click **Next**.
11. Enable **Stream all elementary streams**.
12. Click **Stream**.

To receive the stream *StreamIn1.SrcAddress* value should be *rtsp://[address]:8554/test* where [address] is the IP of the machine where VLC is located.

Sending MPEG-TS over RTP Streams

These are the required settings to generate a RTP Stream output from Viz Engine:

- Set the output system (e.g. *720P_5000_SMPTE296*).
- GPU Direct should be turned off.
- *use_compositor* should be 0.
- An NTP server must be set (e.g. 131.107.13.100).
- The color conversion *rgb_2_yuv* should be set to *shader (=1)*.
- *Matrox0.VideoOut1.SrcUdpPort* should be set to an even port number (e.g. 10000).

Info: The port number should always be even.

- *Matrox0.VideoOut1.DstUdpPort* is the destination port you want to use (e.g. 10002).
- *Matrox0.VideoOut1.DstAddress* is the destination IP address you want to send to.
- *Matrox0.VideoOut1.NetworkInterfaceIPAddress* must be your local NIC IP address.

To verify the correct output, you can use ffplay from ffmpeg tools:

```
ffplay rtp://{source IP of your Viz Engine}:{destination port} e.g. ffplay rtp://10.211.1.26:10002
```

7.30 Video Output

Use the Video Output section to configure special settings for video output, such as SPG settings and so on.

Note: The VGA version of Viz Engine does not have this section.

7.30.1 Video Output Properties (1)

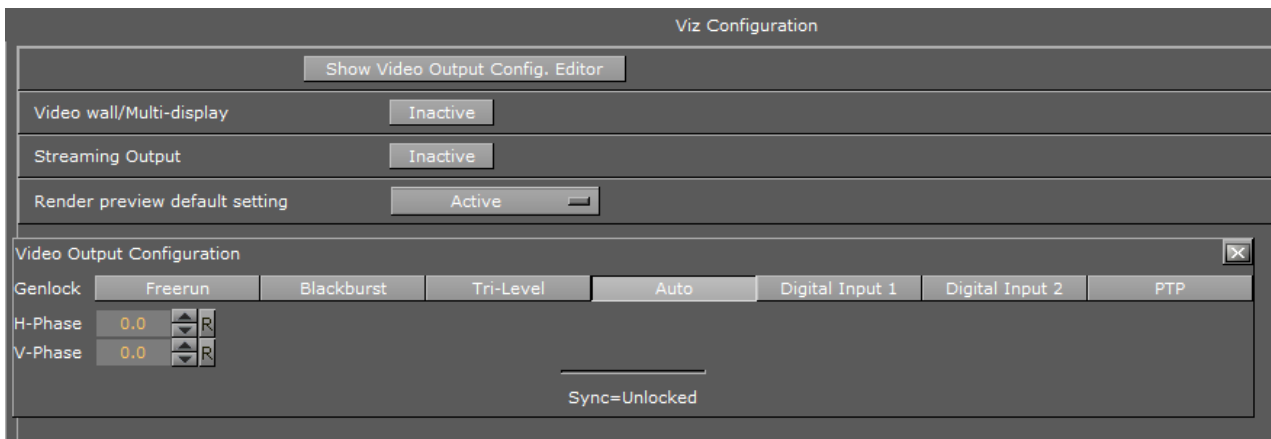

- **Show Video Output Config. Editor:** Opens the Video Output Editor (2). You can also open the Video Output Editor by pressing **ALT + V**.
- **Video wall/Multi-display:** Sets the main output to the Digital Visual Interface (DVI).

Important: For videowall setups, this setting must be active and the output format must be set to **FULLSCREEN**.

- **Streaming Output:** Activates or deactivates IP Streaming output.
- **Render preview default setting:** Sets the default value for the Preview button (see [Control Buttons](#)) when Viz Engine is in On Air mode.
 - **Inactive:** Renders only video out signals. This increases performance, as the renderer does not have to render into an editor on-screen and into pixel buffer.
 - **Active:** Renders both video out signals and on-screen (this decreases performance).
 - **Fullscreen:** Sets the On Air window to screen size.

7.30.2 Video Output Editor

The Video Output Editor defines the synchronization standard and the output signal phases.

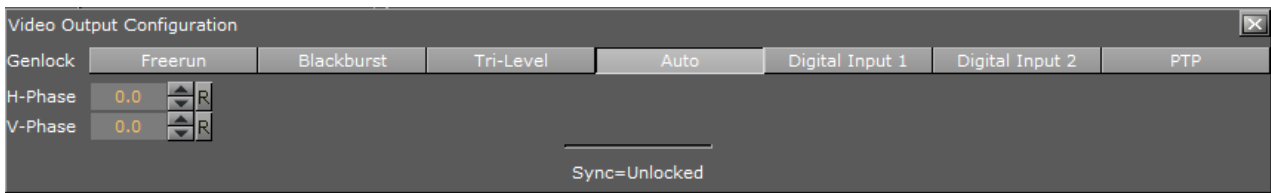

- **Freerun:** Locks Viz Engine to a clock signal on the video board.
- **Blackburst:** Locks Viz Engine to a Blackburst GenLock signal.
- **Tri-level:** Locks Viz Engine to a Tri-Level GenLock signal.
- **Auto:** Auto detects the genlock signal and locks to it.
- **Digital Input 1 and 2:** Locks Viz Engine to the signal on Input 1 or 2.
- **PTP:** Uses a Precision Time Protocol source for synchronizing. Mainly used in IP networks.
- **H-Phase and V-Phase:** Shifts the output signal with respect to the sync signal.

Note: The *Auto* option is only available on Matrox boards . On Matrox boards the h- and v-phase settings are updated automatically as well.

To Make the V- and H-Phase Values Coincide

1. Set the **V-phase value**
 - The *V-granularity* is taken from the genlock.
 - The *V-delay* is calculated from $V\text{-phase} * V\text{-granularity}$.
 - The genlock is set with this *V-delay*.
2. Set the **H-phase value**. Note that there is a distinction whether the H-phase is a positive or a negative value.
 - a. If the **H-phase > 0**
 - The genlock *H-delay* is set to 0.
 - The *H-granularity* is taken from the video out channel.
 - The *H-delay* is calculated from $H\text{-phase} * H\text{-granularity}$.
 - The fill and key channels are set with this *H-delay*.
 - a. If the **H-phase <=0**
 - The fill and key channel *H-delay* is set to 0.
 - The *H-granularity* is taken from the genlock.
 - The *H-delay* is calculated from $-H\text{-phase} * H\text{-granularity}$.
 - The genlock is set with this *H-delay*.

Note: The granularity and possible min/max values are printed to the Viz Artist/Engine console during startup.

It should be taken into account that when the genlock video format is different from the fill/key video format the value of the *V-delay* matches the genlock lines and not the video output lines. The same applies to *negative H-phase* values.

See Also

- [Output Format](#)
- [Video Input](#)

7.31 Video Output: Clip Output

In the Video Output: Clip Output panel, configure the available Clip Channel outputs.

Note: If the Viz Engine being configured is installed as a VGA version, this section is not available in Viz Config.

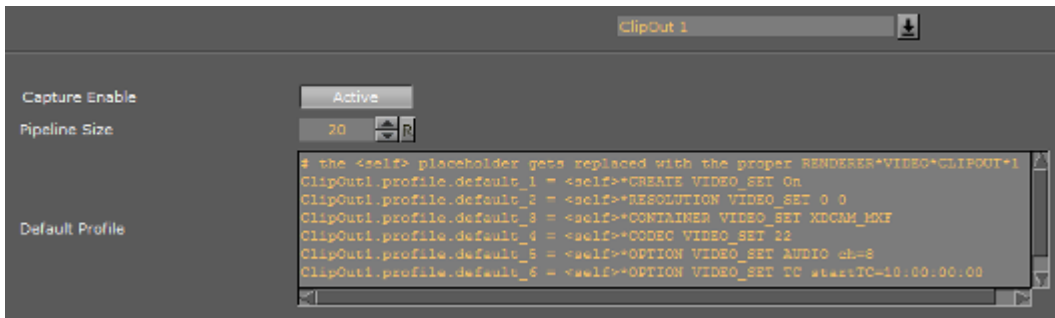

- **Capture Enable:** Enables or disables the clip writer functionality. The main use is to give control over host memory resources. When the clip writer functionality is not needed then the clip out channel does not need to be allocated.
- **Pipeline Size:** Controls the number of frames that the clip writer uses to handle a file. It is recommended to leave the default value.
- **Default Profile:** Contains a default profile that can be loaded on request, with the command `RENDERER*VIDEO*CLIPOUT*1*PROFILE APPLY`. Example:

```
# the <self> placeholder gets replaced with the proper RENDERER*VIDEO*CLIPOUT*1
ClipOut1.profile.default_1 = <self>*CREATE VIDEO_SET On
ClipOut1.profile.default_2 = <self>*RESOLUTION VIDEO_SET 0 0
ClipOut1.profile.default_3 = <self>*CONTAINER VIDEO_SET XDCAM_MXF
ClipOut1.profile.default_4 = <self>*CODEC VIDEO_SET 22
ClipOut1.profile.default_5 = <self>*OPTION VIDEO_SET AUDIO ch=8
ClipOut1.profile.default_6 = <self>*OPTION VIDEO_SET TC startTC=10:00:00:00
ClipOut1.profile.default_7 = <self>*NAME SET d:/out/<base_scene2_name>/
<clip_name>
```

7.31.1 Placeholders for Variables

Placeholder	Description
<hostname>	Expands to the host name
<if0>	Expands to the IPV4 network address of the first network interface

Placeholder	Description
<if1>	Expands to the IPV4 network address of the second network interface
<if2>	Expands to the IPV4 network address of the third network interface
<absolute_scene_name>	Expands to the complete path of the loaded scene
<absolute_scene2_name>	Expands to the complete path of the loaded scene

7.32 Video Output: SHM Output

Configure Shared Memory Output channels from this panel. The shared memory output is only available on systems with non-IP Matrox video boards, or if **Check Video Card** is set to None in the [Video Board](#) section.

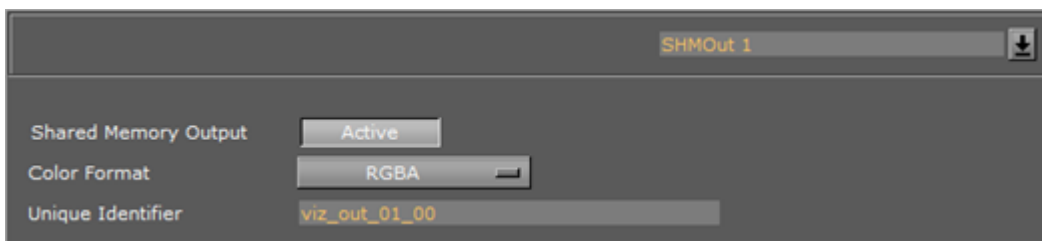

- **Shared Memory Output:** Sets the output mode for Shared Memory. Options are Active or Inactive.
- **Color Format:** Displays the active color format for the configured SHM Output.
- **Unique Identifier:** Changes the name of the Shared Memory if required. Used when connecting to services such as Viz Coder.

7.33 Viz Artist 2.X

In the Viz Artist 2.x panel, Viz Artist 3 can be switched to Viz Artist 2 mode for compatibility issues.

7.33.1 Viz Artist 2.x

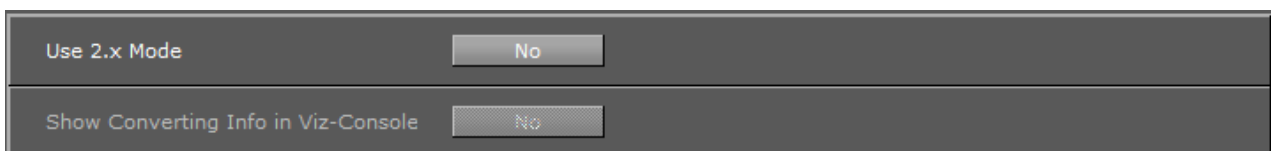

In Viz Artist versions before 3.0, assets were stored in specific subdirectories (Scene, Geometry, Material, Font, and Image). As Viz Artist 3 stores assets anywhere in the directory, older control applications may not find these assets. Viz looks for assets in these subdirectories when 2.x mode is enabled, and calls for scenes are represented by green lines in the console window.

When working in 2.x mode, *Viz_2x* is automatically added before the default messaging path. Furthermore, the paths sent by the external control applications are converted to lower case (as the names of the data are converted to lower case when importing). External control programs must not be re-written when migrating from Viz Artist 2 to 3.

- **Use 2.x mode:** Enables Viz Engine to run in 2.x mode.
- **Show converting Info in Viz-Console:** Enables the calls for scenes to be shown as green text.

Note: It is only recommended to use 2.x mode if new scenes are organized according to the old 2.x data structure.

7.34 Viz License Information

In the Viz Artist/Engine License Information panel, information about the current Viz Artist/Engine license is shown. The panel lists the various licensed features, for example, the available plug-in packages.

7.34.1 WIBU Licensing View

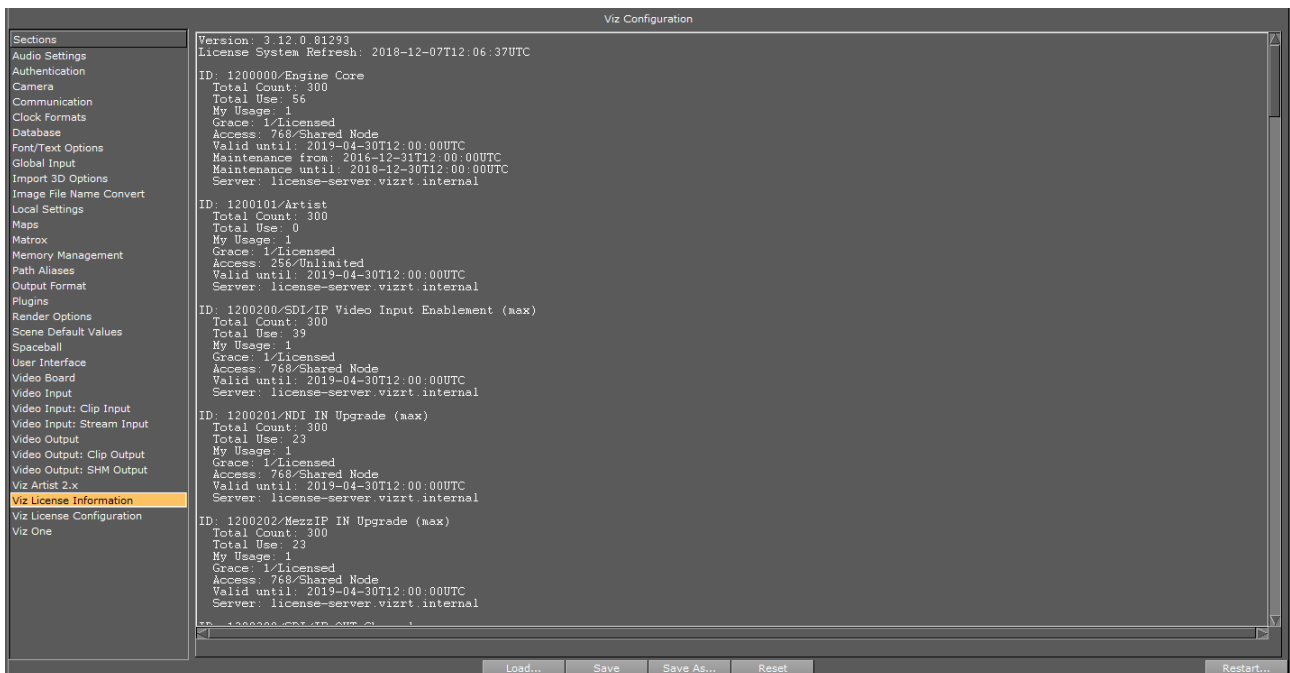

7.34.2 Old Hardlock Licensing View

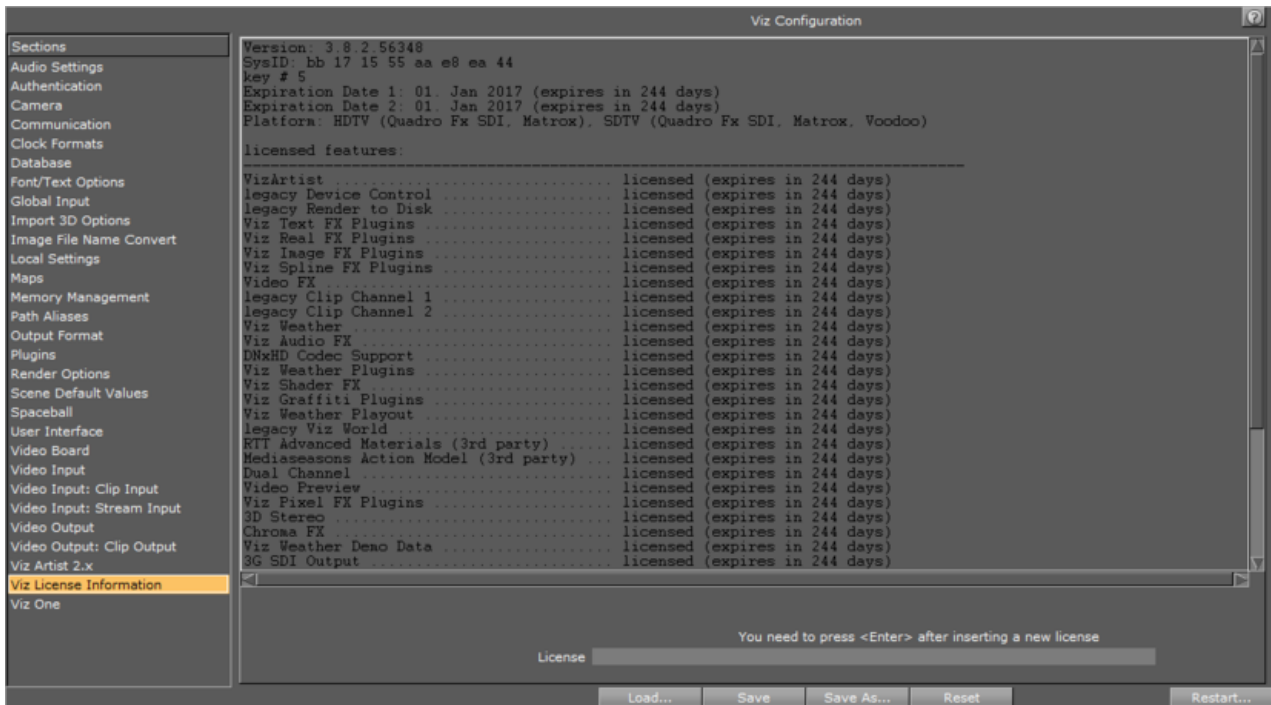

- **License:** Enter a license key into the License field, press **ENTER**, and click **Save**. Restart Viz Artist/Engine for the new license key to take effect.

7.35 Viz License Configuration

The License Configuration allows users to configure their Viz Engine for WIBU Licensing.

New License Mode	Yes	
License Location	Local license	Network license
Core License	Engine Core	
Combination Feature	None	
Additional Licenses	Artist	
	SDI/IP Video Input Enablement (max)	
	NDI IN Upgrade (max)	
	MezzIP IN Upgrade (max)	
	SDI/IP OUT Channel	
	NDI OUT Channel	
	MezzIP OUT Upgrade (max)	
	4K Video Enablement	
	DVI OUT Max Resolution	
	Multiple Frameservers (max)	
	Chroma FX	
	Global Illumination FX	
	Vizrt Multi-touch Plugin Package	
	Cinema 4D Import	
	Dolby E Decoder License	
	Dolby E Encoder License	
	Viz Engine DNxHD Codec Support	
	RTT Shaders FX	
	Substance FX Authoring	
	ezGallery	
	ezPostFx	
	ezShaders	
	ezMesh	
ezDeform		
ezComposer		
ezLogic		
ezLink		
ezTubular		
ezJavascript (Pro)		
DornaMT APP		
DornaMT Plugin		

Any modification requires a restart to take effect!

To switch to the WIBU Licensing Mode, set the **New License Mode** to Yes. If set to No, the Hardlock Licensing Model is going to be used. License Location specifies the location the system searches for a WIBU license. This can either be *Local license* or *Network license*.

- **Local License:** Requires either a WIBU Dongle connected to the system or a file based license.
- **Network license:** Requires a WIBU License server to be present and the server must be listed in the Server Search list of the WIBU Configuration.
- **Core License** selects the Core a user must acquire to start Viz Engine. The can be either:
 - Engine Core
 - Preview Core
 - Artist Free

If a Engine core has been selected, the user can also chose of a set of combination features that enables the use of one of

- **Combination Feature DVI:** For any screen based out (DVI) up to 2K.
- **Combination Feature Mezzanine IP:** Enables any "software based" IP in and output (e.g. a RTP stream based workflow).
- **Combination Feature NDI:** Enables Newtek NDI workflow.
- **Combination Feature Frameserver (Mux ports):** Enables communication via MUX ports if the engine is going to be used as a frameserver when enabled.

Note: Only one Combination feature can be acquired per node. If you need to run more than one instance, any additional instance may not acquire a combination feature anymore.

Based on the Core license, Additional Licenses can be chosen. For a full overview which features each individual license enables, please refer to [New WIBU based Licensing System](#).

Important: Any change in the license configuration requires a restart of Viz Engine.

7.36 Viz One

To enable data exchange between Viz One and Viz Engine, two services are required:

- A Viz One File System Monitor (Fsmon) Service (monitors files which are located in the Clip Data directory location (--root=d:)).
- A File Transfer (Mediaftp) Service (transfers files to the Viz Engine).

Both services are part of the Viz Artist/Engine installation by default, but they must be installed or removed as a service through this panel.

! **IMPORTANT!** If the location of the Clip Data directory is changed after installation, remove and install the two services again. They automatically set to the new Clip Data Directory (see [Local Settings](#)).

To search, view and select video clips from Viz One, configure the [Viz One Browser](#).

! **Note:** Viz Artist features a *Viz One Transfer Status* pane that shows the progress of any active and finished clip transfers from Viz One. This pane requires the MediaFTP (File Transfer) and Fsmon (File System Monitor) services to be installed and running, and the correct configuration of the Viz One MessageQueue Server.

To use Viz One with Viz Artist, each Viz Artist/Viz One integration must be authenticated through the [Authentication](#) panel in the Viz Configuration. See [Integration with Viz One](#) for the Fsmon and Mediaftp install and remove procedures.

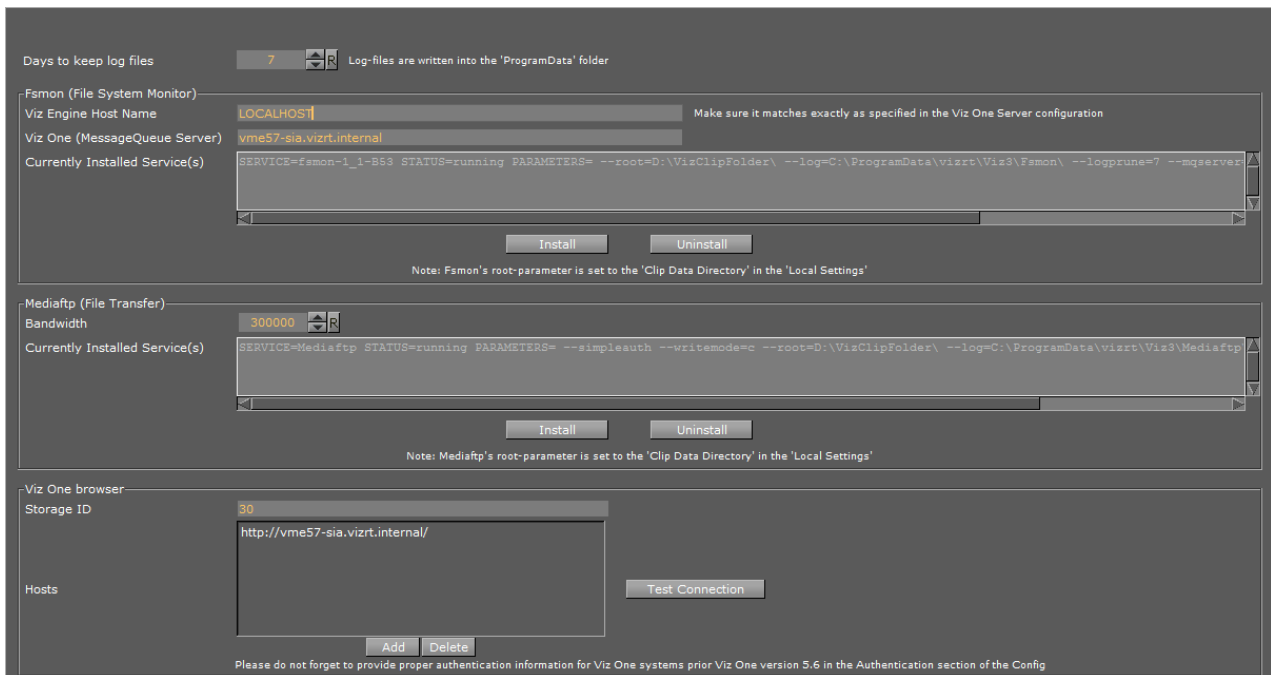

7.36.1 Viz One Properties

This section details the properties of the Viz One configuration panel.

- **Days to keep log files:** Sets the number of days to keep log files (default is seven days). Log files older than the set number of days are deleted

Fsmon (File System Monitor)

- **Viz Engine Host Name:** Sets the name of the local host (local host name entered by default). Make sure that the host name is exactly the same as the string specified in the Viz One Server Configuration
- **Viz One (MessageQueue Server):** Sets the host name of the active Message Queue server (do not use a protocol prefix, e.g., <http://>)

IMPORTANT! To view and transfer files in Viz Artist, the host name entered in the **Viz One (MessageQueue Server)** must also be entered in the **Viz One Browser** panel.

- **Currently Installed Service(s):** Shows the currently installed Fsmon service, with its parameters
- **Install/Uninstall:** Installs and removes a Fsmon service

Note: Any currently installed service must be removed before a new service can be installed.

Mediaftp (File Transfer)

- **Band Width:** Sets the transfer bandwidth, in Kbits per second
- **Currently Installed Service(s):** Shows the currently installed Mediaftp service with its parameters
- **Install/Uninstall:** Installs and removes a Mediaftp service

Note: Any currently installed service must be removed before a new service can be installed.

Viz One Browser

This is the configuration for the Viz One Browser in the Media Asset tab (see the Media Asset section of the [Viz Artist User Guide](#)).

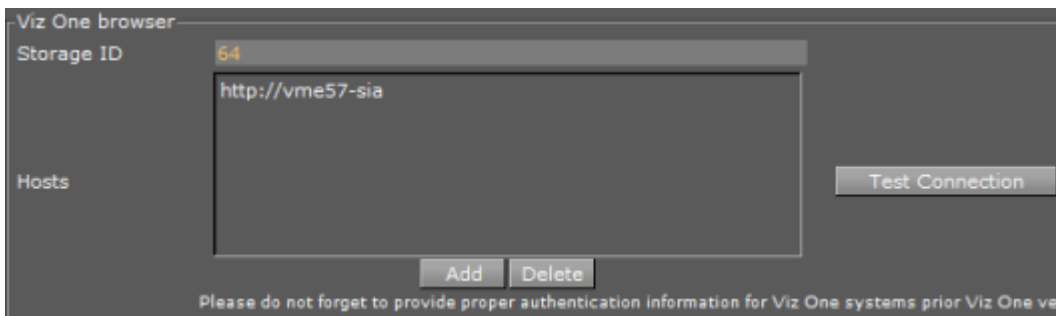

- **Storage ID:** Displays the Storage ID for Viz Artist as configured in Viz One.
- **Hosts:** Opens a dialog to provide Viz Engine with the host-name for the desired Viz One instance when the **Add** button is clicked. The host name must include the protocol prefix, for example: `http://vme57-sia`. To remove a previously configured Viz One instance, select it from the list of hosts and click the **Delete** button.
- **Test Connection:** Selects the desired host and click the **Test Connection** button to check if the configured Viz One connection is working correctly.
 - If Test Connection returns that the Viz Engine is not registered as a Video Server, the Engine must be added as a server in the Viz One Studio Administration. Please refer to the Viz One documentation for further information.

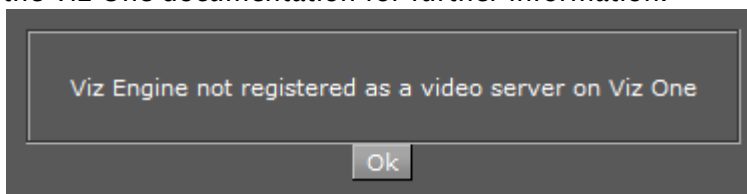

- If Test Connection returns a Storage ID mismatch, please adjust the **Storage ID** field accordingly.

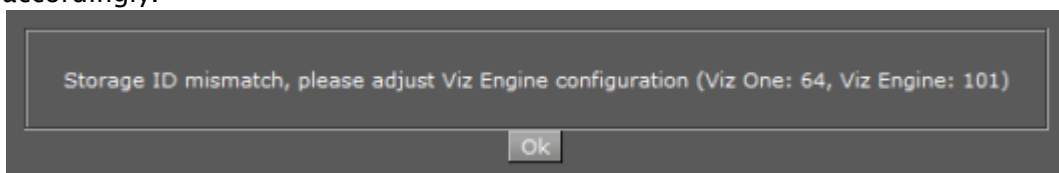

- If Test Connection returns that the connection is valid, the Viz One instance has been configured correctly and is ready for use with Viz Engine.

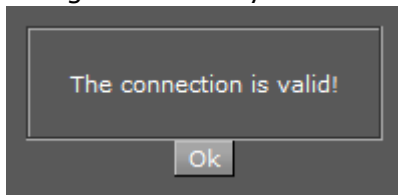

7.37 Viz Artist/Engine Log Files

All Viz Artist/Engine log files are located in the *<viz data folder>*.

Note: This is normally at *C:\ProgramData\Vizrt\viz3*. Check the directory name with the command `echo %programdata%` from a Windows command prompt. This directory is by default hidden in Windows, so to navigate to this directory in Windows Explorer specify the explicit path.

Viz Artist/Engine can provide various log files as documented in the section below.

7.37.1 Viz Render Log

- **Name:** *VizRender_<timestamp>.log*
- **Purpose:** Provides information on current status of Viz Engine.

7.37.2 Viz Trace Log

- **Name:** *VizTrace_<timestamp>.vlog*
- **Purpose:** Provides command trace that facilitates playback for error reproduction, contains at most the last 500 commands.

7.37.3 Viz Gui Log

- **Name:** *VizGui .log*
- **Purpose:** Provides information on Viz Gui errors.
- **Log Description:** Each line in the log file has six components or entries, each separated by pipe (|). A typical log-line looks like:

```
Tue Nov 04 10:02:15 EST 2014|LM_ART|5420|Version: 3.7.1.42057|CONFIG|GPU1
```

The components for each log-line are:

- Date/time
- Type, one of:
 - LM_STARTUP (Regular startup)

- LM_QUIT (Regular quit)
- LM_QUIT_TIMEOUT (Timeout quit)
- LM_QUIT_LOGIN (Login canceled)
- LM_CFG (Restart with configuration)
- LM_ENG_GUI (Restart engine with GUI)
- LM_ENG (Restart engine without GUI)
- LM_ART (Restart of Artist)
- LM_ (Current mode restarted)
- Pid (Process id)
- Viz version
- Mode:
 - CONFIG (Config Mode)
 - NOGUI (Engine Mode)
 - NORMAL (Artist Mode)
- Starting on GPU<x>, for example *GPU1* (Graphical Processing Unit number one)

7.37.4 Viz Shaders Log

- **Name:** *VizShaders.log*
- **Purpose:** Provides information on shader compilation.

7.37.5 Viz Console Log

- **Name:** *Viz_<timestamp>.log*
- **Purpose:** Logs console output to a file when the engine is started without console (-c option).

7.37.6 Viz Gui Connection Log

This Log is created if 'Write GH Connection Log' is active (see [Local Settings](#)).

- **Name:** *VizGuiConnection<timestamp>.log*
- **Purpose:** Provides information on the Graphic Hub Manager database connection.

7.37.7 Create Log Files with Log and Clog Commands

The output of the Viz Engine can be redirected to a file using the command `log <filename>`, for example, `log c:\temp\my-engine-log.txt`. Note that the log file has no content until the Viz Engine in-memory buffers are flushed, meaning written to disk. The log memory buffers are flushed to disk either when the buffer are full or when Viz Engine quits. You can force the buffer to be written to the log file on disk by sending the command: **CONSOLE FLUSH**

You can take an immediate snapshot of the Engine's current in-memory log with the command "**clog**". A new log file is immediately written to `<viz data folder>\VizRender-ID.log`. The ID in the filename is the GPU ID, making it easy to differentiate log files in a Dual Engine setup for example.

Both the **log** and **clog** commands can be executed by sending them to Viz or by entering them directly in the Engine Console window.

Click on the  button to access the Console window.



8 On Air Mode

The On Air interface may vary, depending on the software and hardware configuration used. In Viz Artist, designers can click the On Air button on the main menu to switch Viz Artist from a modeling tool to a render engine. The application then waits for control commands; however, scene animations can also be rendered by the use of the [Control Buttons](#) (top-left corner).

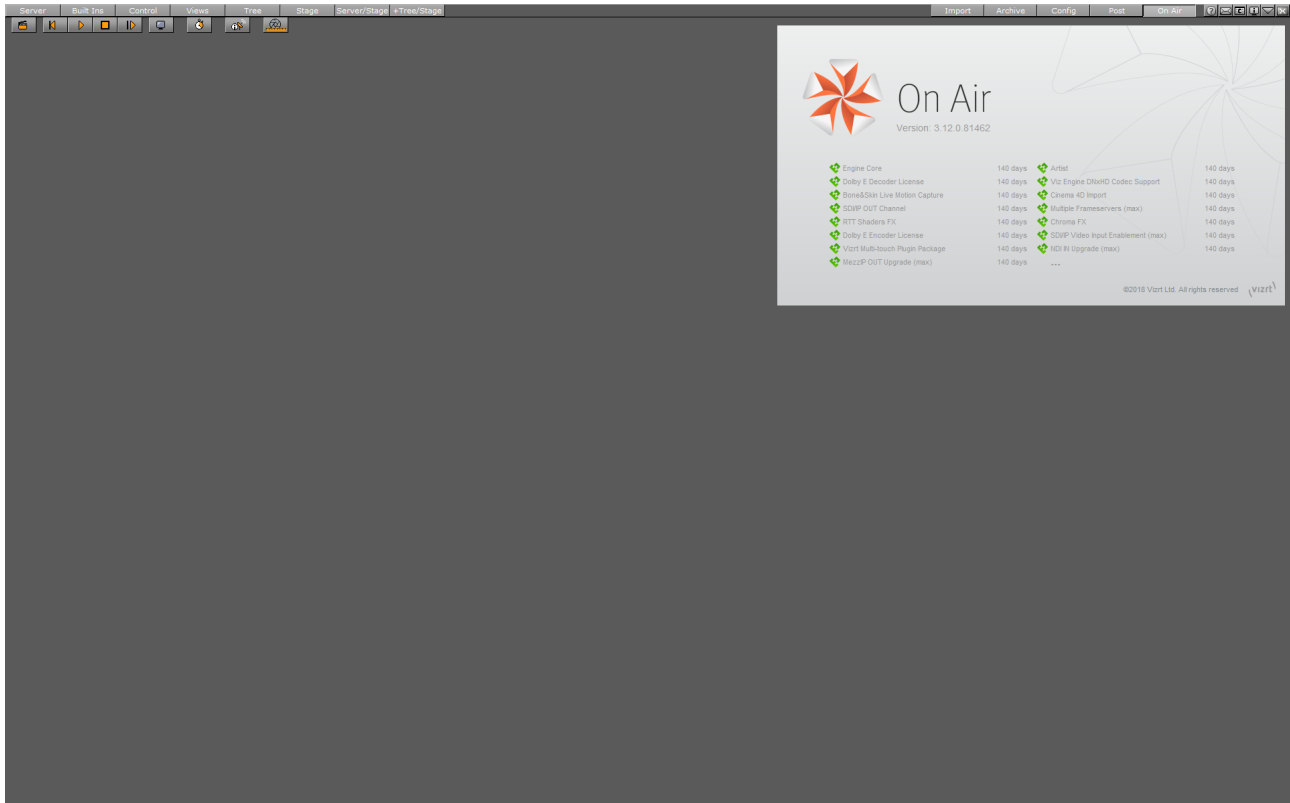

The top left of the On Air screen shows a set of [Control Buttons](#), as well as a [Performance](#) button. All [License Information](#) is shown at the top right of the screen. Depending on the software and hardware settings, additional buttons and information is available. For example in design mode, the scene is shown in an output window (lower right).

This section contains information on the following topics:

- [Director Control Pane](#)
- [Control Buttons](#)
- [Performance](#)
- [On Air Information Panel](#)
- [License Information](#)

8.1 Director Control Pane

The clapper board button, when in On Air mode, opens the Director Control Panel window.

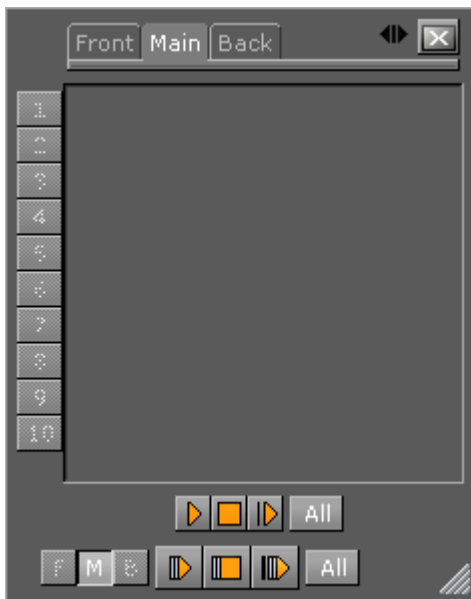







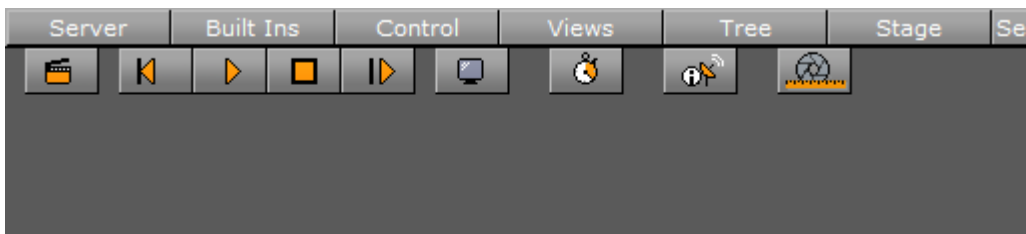

The Director Control Panel window can be used to select and animate one, multiple or all directors in the front, main or back layer. In addition it can be used to set slots and to animate a combination of director(s).

See the **Director Control Panel** page in **The Stage for Animation** section of the [Viz Artist User Guide](#) for a detailed description of the Director Control Panel.

8.2 Control Buttons

This section contains information on the Controls Buttons, which include the Play and the On Air buttons.



-  **Clapper Board:** Shows or hides the [Director Control Pane](#) window.
-  **Back:** Jumps to the beginning of the animation in the scene.
-  **Play:** Starts the animation of the scene.
-  **Stop:** Stops the animation of the scene.
-  **Continue:** Continues the animation after it stopped at a stop point.
-  **Render Preview:** Shows or hides the VGA Preview window.
-  **Performance Editor:** Shows or hides the [Performance Bar](#).
-  **System Information:** Shows or hides the [On Air Information Panel](#) window.

-  **Lens File Editor:** Shows or hides the Lens File Calibration Editor. Use to adjust the lens files for virtual studios. Adjust the field of view, lens distortion, mobile point and center shift. It is useful in combination with lens calibration.

8.3 Performance

Analyzing the performance of Viz Artist/Engine can be done with two tools:

- **Performance Bar:** The Performance Bar closely monitors a range of parameters for analyzing real-time performance
- **Performance Analyzer:** The Performance Analyzer monitors key performance and camera parameters, as a head-up display in the renderer window and initiate logging of statistic, command and event information to log files.

This section contains information on the following topics:

- [Performance Analyzer](#)
 - [To Open the Performance Analyzer](#)
- [Performance Bar](#)
 - [To Open the Performance Bar](#)

8.3.1 Performance Analyzer

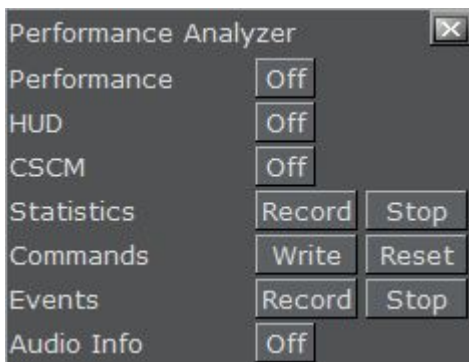

The performance analyzer enables key performance and camera information to be shown in the renderer view as a head-up display. Additionally the performance analyzer can be used to initiate writing of statistic, command and event information to the log files.

- **Performance:** Shows the current (CUR) and (MAX) parameters (see Performance Bar).
- **HUD:** Enables the head-up display (HUD) showing the following parameters in the renderer view:
 - **Camera 1-n:** Shows the currently selected camera.
 - **Position:** Shows the camera's X, Y and Z position.
 - **Pan/Tilt/Twist:** Shows the camera's pan, tilt and twist parameters.
 - **FovX/FovY:** Shows the camera's field of view (FOV) for the horizontal (X) and vertical (Y) plane.
 - **Center Shift:** Shows the X and Y position of the camera's center shift.
- **CSCM:** Shows the center shift marker as a cross hair in the renderer.

- **Commands**
 - **Write:** Writes a log file onto the hard disk.
 - **Reset:** Stops recording commands and starts a new record.
- **Events**
 - **Write:** Writes a log file onto the hard disk.
 - **Reset:** Stops recording commands and starts a new record.
- **Audio Info:** Turns on/off a visual representation of the audio mixing.

The Log files can be found in the *<viz data folder>*.

To Open the Performance Analyzer

Hold **CTRL** while clicking the right mouse button on the **X** (close) button in Viz.

8.3.2 Performance Bar

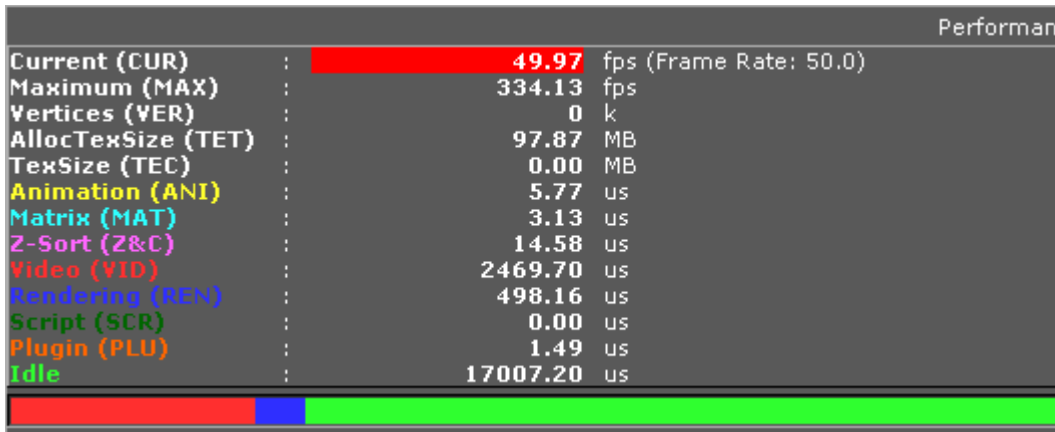

The performance bar gives an idea of the current scene rendering performance (frames per second).

- **Current (CUR):** Shows how many frames per second the scene renders in On Air mode. The number should be above 50 (PAL) or 60 (NTSC), according to the rate that has been specified in the [Output Format](#) section.
- **Maximum (MAX):** Shows how many frames per second the scene can render at without waiting for vertical retrace. The higher the maximum value, the more performance is left. If the maximum value is reduced to below 50 or 60, the scene is not rendering in real-time.
- **Vertices (VER):** Shows the number of vectors in the scene.
- **AllocTexSize (TET):** Shows the total allocated size of texture memory.
- **TexSize (TEC):** Shows the size of the currently used texture memory.
- **Animation (ANI):** Shows how many microseconds all active directors and animation channels take. This indicator is linked to the yellow bar.
- **Matrix (MAT):** Transforms each container in the scene into world coordinate space. This indicator is linked to the cyan bar.

- **Z-Sort (Z&C):** Refers to Z-sort and Culling, and sorts all containers for correct transparency drawing and determines if containers are visible in the current camera view. This indicator is linked to the pink bar.
- **Video (VID):** Shows how many microseconds video input (live video texture) and video output take. De-interlaced video inputs take longer time than progressive and interlaced. The only way to improve this value is to use a faster system. This indicator is linked to the red bar.
- **Rendering (REN):** Shows how many microseconds it takes to render all objects on the screen. A faster graphics card improves this value. This indicator is linked to the blue bar.
- **Script (SCR):** Shows the consumed time in microseconds from all active scripts. This indicator is linked to the dark green bar.
- **Plugin (PLU):** Indicates how much time in microseconds all active plug-ins spend in each render cycle. This indicator is linked to the orange bar.
- **Idle:** Shows available resources in microseconds the renderer has available. This indicator is linked to the light green bar.

To Open the Performance Bar

1. Click the performance bar button .
 2. To see all parameters, extend the view by clicking the **Eject** button.
-

8.4 On Air Information Panel

The On Air Information panel shows the required parameters to send external control commands and all connected clients, with the IP address, host name and Viz Port.

 **Note:** Polling for On Air information can decrease the performance. For information on how to adjust the On Air Update Interval, see the [User Interface](#) page of Viz Configuration.

8.4.1 Basic Tab

In the Basic tab, the parameters required to send external control commands are shown:

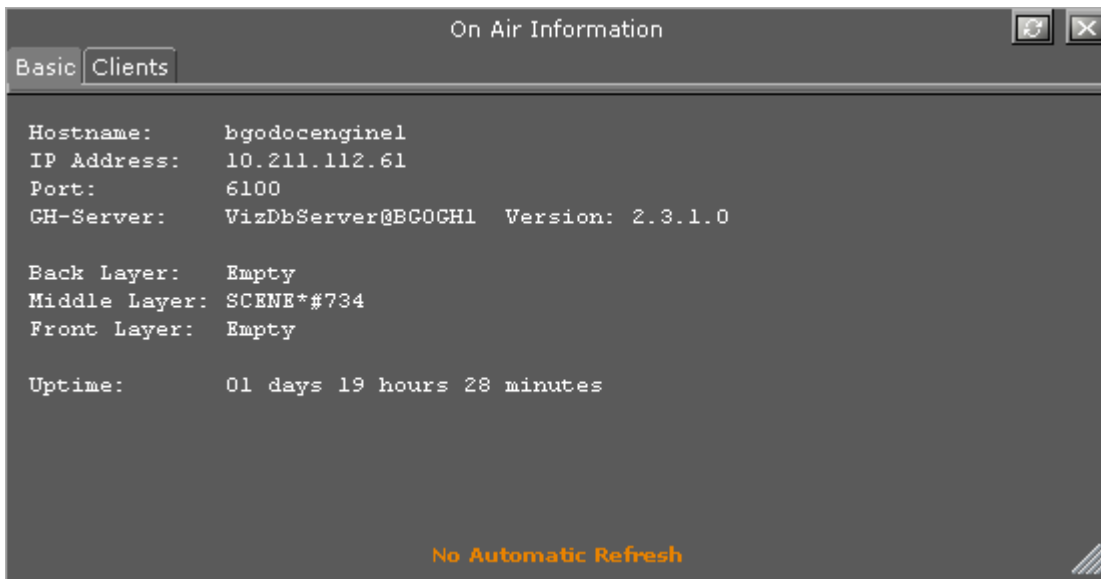

- **Refresh button:** Refreshes the status information.
- **Hostname:** Shows the name external control programs can use to communicate with Viz Artist.
- **IP Address:** Shows the IP address external control commands can communicate with Viz Artist.
- **Port:** Shows the port Viz Artist is using. Default port is 6100, but may be changed in the **Communication** section of Viz Configuration.
- **GH-Server:** Shows the Graphic Hub Manager server Viz Artist is connected to.
- **Back Layer:** Shows the name of the scene that is defined to run in the background of the middle and front layer scene(s).
- **Middle Layer:** Shows the name of the scene that is defined to run in the middle between the back and front layer scene(s).
- **Front Layer:** Shows the name of the scene that is defined to run in the foreground of the back and middle layer scene(s).
- **Uptime:** Shows the time elapsed since Viz was started.

8.4.2 Clients Tab

In the Clients tab, all connected clients are shown with the IP address, host name and Viz Port.

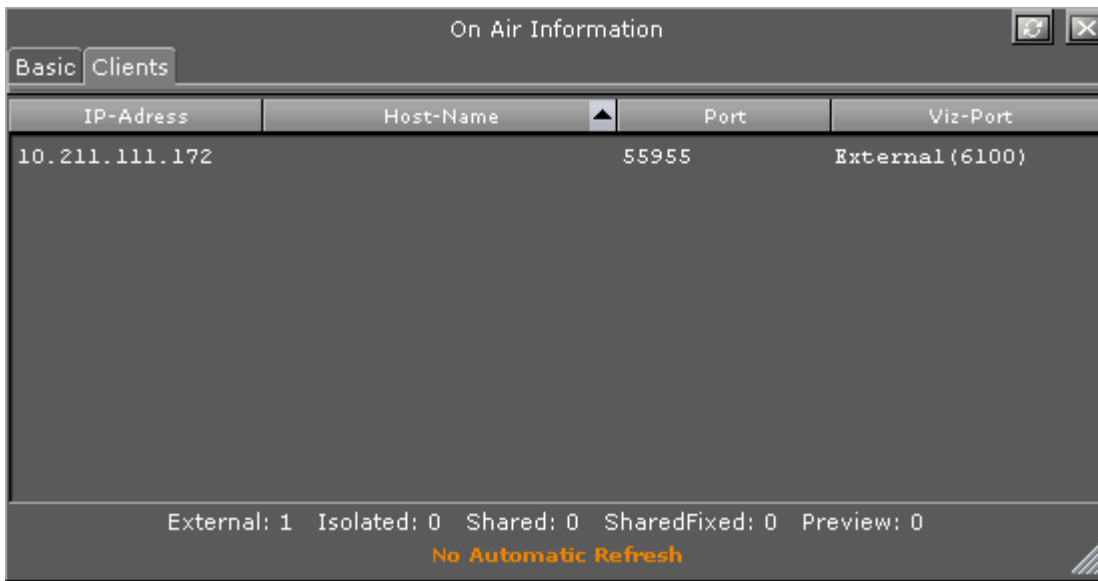

8.5 License Information



The license information listing shows licensed features and how many days a given license has left before it must be renewed.

9 Video IO Related Configuration And Features

These chapters list some common Video IO related configurations which mainly apply to Matrox board unless stated differently.

This section contains information on the following topics:

- [High Dynamic Range \(HDR\)](#)
- [Mixed Mode Video Support](#)
- [Frame Accurate Output](#)
- [Shared Usage of Input Channels](#)
- [Dynamic Channel Allocation](#)
- [Supported Matrox Codecs](#)
- [Configuration History for Matrox X.mio and DSX Series](#)
- [DVE Performance](#)
- [Matrox Watchdog Configuration](#)

9.1 High Dynamic Range (HDR)

High Dynamic Range (HDR), often in combination with wide color gamut (WCG), is a way to improve the colors shown on screens.

9.1.1 Supported Color Formats

These are the supported SDR/HDR color formats of Viz Engine 3.12 (or higher):

SDR	HDR
ITU-R BT.601	ITU-R_BT.2100 PQ
ITU-R BT.709	ITU-R_BT.2100 HLG
ITU-R_BT.2020	ITU-R_BT.2100 SLOG3

Those standards are mainly known as HDR10.

BT 2020

BT.2020 is a color space with a WCG. It covers a larger subset of visible colors than, for example, BT.709. Currently, all HDR settings in VizEngine use the BT.2020 color space with ten bits per component (bpc) color depth.

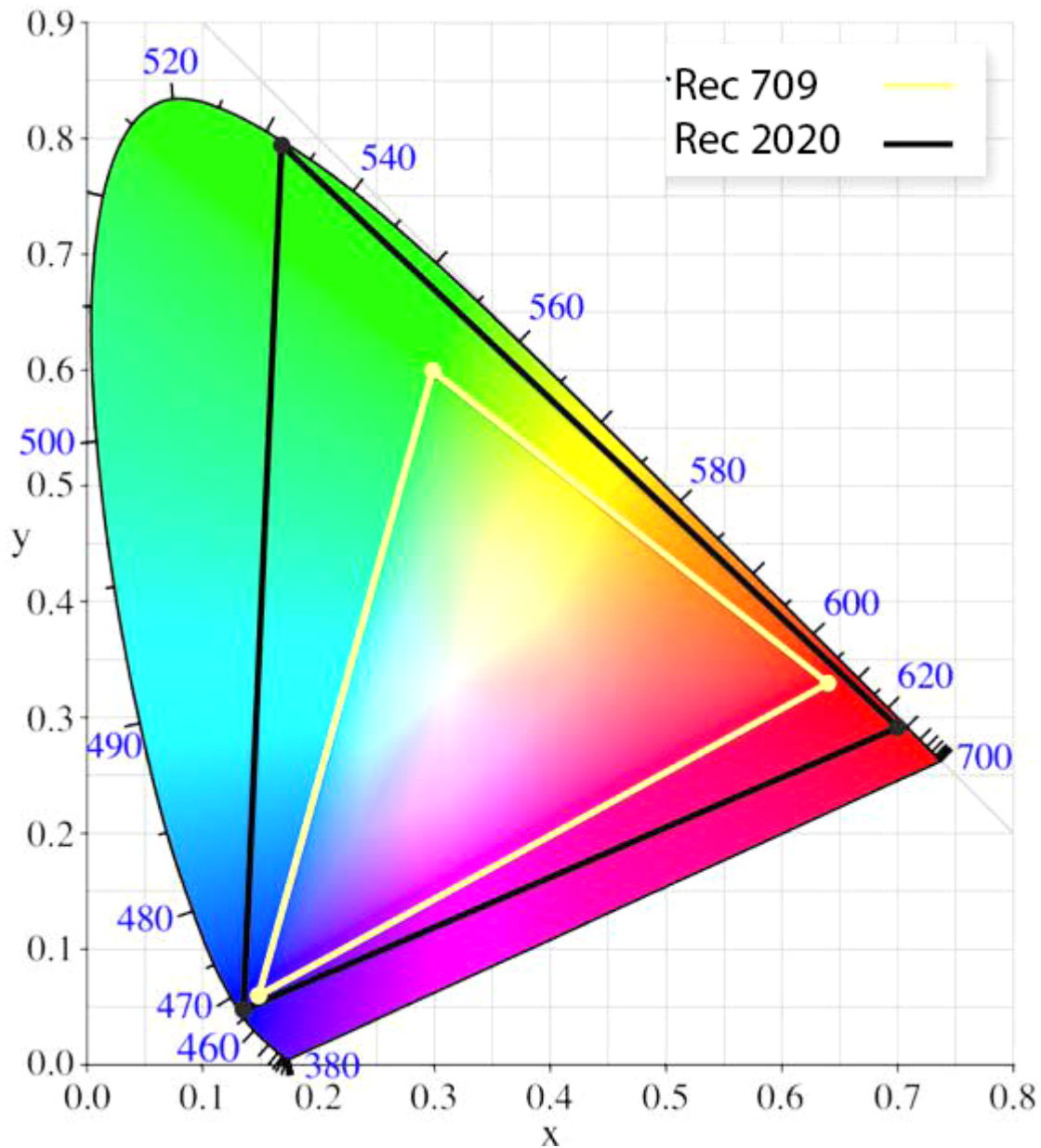

PQ (Perceptual Quantization)

PQ is standardized as SMPTE ST 2084. PQ defines the luminance levels up to 10,000 cd/m² (nit).

HLG (Hybrid Log-Gamma)

HLG provides a relative value tied to the gamma and logarithmic curve. This system supports practical luminance levels from 1,000 up to 2,000 cd/m². HLG is compatible with conventional SDR systems, so TVs that do not support HDR can reproduce HDR.

SLOG3

S-Log is a gamma curve with a wide dynamic range optimized under the assumption that grading is performed in the post-production process. S-Log3 allows for better reproduction of gradation characteristics in shadows and the mid-tone range than previous S-Log versions. It has characteristics closer to those of scanned film.

9.1.2 Requirements

- Matrox System Topology video card (X.mio3 or DSX LE4).
- 1080p or UHD resolution.

9.1.3 Limitations

- Expect higher delays when using HDR in UHD environments due to increased processing requirements. In that case, the ringbuffer needs to be turned on, but can be set lower than the default value of 5. (e.g. =1)
- Rendering in HDR requires a lot of GPU power. At least a NVIDIA P6000 is required.

9.1.4 Configuration

Most of the settings required for HDR are not yet accessible through the GUI. These settings must be changed in the Viz Engine config file.

Output

- Set the output format to 1080p or UHD.
- Set the colorimetry of the output: `output_colorimetry = ITUR_BT_2100_HLG`.
- Set the bits per component of the output (can be eight or ten): `output_bpc = 8`.

Other options are `ITUR_BT_2020`, `ITUR_BT_2100_PQ`, and `ITUR_BT_2100_SLOG3`. Specifying `ITUR_BT_601` or `ITUR_BT_709` is possible, but redundant. BT.601 is always used for SD resolutions (NTSC, PAL) and BT.709 is the default value for all other resolutions.

Input

Currently, only live and clip input are supported on X.mio3 video cards.

- Set the input to the same resolution and framerate as the output.
- Set the colorimetry (`live_colorimetryX` or `clip_colorimetryX`, respectively) to the same colorimetry as the output.
- Set the bits per component of the inputs (can be eight or ten): `live_bpcX = 10` or `clip_bpcX = 10`.
- Use the input as DVE.

Currently, no conversions between different frame rates or resolutions are supported when HDR is used. Clip input channels can only play clips that have the same resolution.

Renderer output

- Set the renderer to use 16 bits per channel: `bits_per_channel = 16`.
- Set the color space conversion (CSC) to shader: `rgb_2_yuv = 1`.

⚠ Note: When HDR is enabled, shader CSC and GPU direct can be used in combination. Ringing Filter is not available in HDR. Also, rendering for HDR requires much more GPU power than SDR does.

9.2 Mixed Mode Video Support

This section gives an overview of the Matrox mixed mode video support. The tables are valid for both genlock families in Viz Engine. One is 25/50 (e.g. PAL/720p50/1080i25/1080i50) and the other is 30M/60M (e.g. NTSC/720p60M/1080i30M/1080i60M).

The genlock family refers to the used house signal (e.g. black burst) frequency, typically PAL for the first and NTSC for the latter. Please observe that genlock families can not be mixed.

The following contain information on the following topics:

- [Source: PAL or NTSC](#)
 - [Video In to DVE and Texture](#)
 - [Clip In to DVE and Texture](#)
- [Source: 720p](#)
 - [Video In to DVE and Texture](#)
 - [Clip In to DVE and Texture](#)
- [Source: 1080i](#)
 - [Video In to DVE and Texture](#)
 - [Clip In to DVE and Texture](#)

9.2.1 Source: PAL or NTSC

The first two tables show video in to DVE and texture output capabilities, while the next two tables show clip in to DVE and texture output capabilities. Please observe that genlock families can not be mixed.

Video In to DVE and Texture

Output DVE	Video In		
	PAL/NTSC	720p	1080i
PAL/NTSC	OK	-	-
720p	-	-	-

Output DVE	Video In		
1080i	OK	-	-

Output Texture	Video In		
	PAL/NTSC	720p	1080i
PAL/NTSC	OK	-	-
720p	OK	-	-
1080i	OK	-	-

Clip In to DVE and Texture

Output DVE	Clip In		
	PAL/NTSC	720p	1080i
PAL/NTSC	OK	-	-
720p	-	OK	-
1080i	OK	OK	-

Output Texture	Clip In		
	PAL/NTSC	720p	1080i
PAL/NTSC	OK	-	-
720p	OK	OK	-
1080i	OK	OK	OK

9.2.2 Source: 720p

The first two tables show video in to DVE and texture output capabilities, while the next two tables show clip in to DVE and texture output capabilities. Please observe that genlock families can not be mixed.

Video In to DVE and Texture

Output DVE	Video In		
	PAL/NTSC	720p	1080i
PAL/NTSC	-	-	-
720p	-	-	OK
1080i	-	-	OK

Output Texture	Video In		
	PAL/NTSC	720p	1080i
PAL/NTSC	-	OK	-
720p	-	OK	-
1080i	-	OK	-

Clip In to DVE and Texture

Output DVE	Clip In		
	PAL/NTSC	720p	1080i
PAL/NTSC	OK	-	-
720p	-	OK	-
1080i	OK	OK	OK

Output Texture	Clip In		
	PAL/NTSC	720p	1080i
PAL/NTSC	OK	OK	-
720p	OK	OK	-

Output Texture	Clip In		
1080i	OK	OK	OK

9.2.3 Source: 1080i

The first two tables show video in to DVE and texture output capabilities, while the next two tables show the clip in to DVE and texture output capabilities. Please observe that genlock families can not be mixed.

Video In to DVE and Texture

Output DVE	Video In		
	PAL/NTSC	720p	1080i
PAL/NTSC	-	-	-
720p	-	-	-
1080i	-	-	OK

Output Texture	Video In		
	PAL/NTSC	720p	1080i
PAL/NTSC	-	-	OK
720p	-	-	OK
1080i	-	-	OK

Clip In to DVE and Texture

Output DVE	Clip In		
	PAL/NTSC	720p	1080i
PAL/NTSC	OK	-	-
720p	-	OK	-
1080i	OK	OK	OK

Output Texture	Clip In		
	PAL/NTSC	720p	1080i
PAL/NTSC	OK	-	OK
720p	OK	OK	OK
1080i	OK	OK	OK

9.3 Frame Accurate Output

At the moment, the frame accurate commands only work with DVE as clip target. Due to different usage of the ringbuffer (another place in the timeline) the texture target is not working.

This section contains information on the following topics:

- [Prerequisites](#)
- [Configure Frame Accurate Output](#)
- [Commands](#)
- [General Purpose I/O Commands](#)
- [Timed Command Execution](#)

9.3.1 Prerequisites

Frame accurate playout can be achieved by using a Timecode Reader card (e.g. Plura AVPCL) and sending timed commands from any control application (like Media Sequencer). Scenes need to be loaded and cued some time ahead and then taken On Air at a given timecode. To make sure clip handling is fast, the system has to be configured to use either a RAID-0 hard disc configuration or SSDs.

Frame accuracy is only supported on Matrox boards. For further details, see the [Configure Frame Accurate Output](#) section.

Clips need to be defined within the stage and the pending player needs to be active. As all of the clip players are initialized at first use, it is necessary to do so prior to starting a frame accurate scene. Do this by loading a dummy scene that has all clip channels set to either DVE or texture mode and a valid clip name given.

⚠ Note: It can take up to four seconds for the clip players to initialize. Do this a second time to also initialize the pending clip players. Please keep in mind that this procedure is only needed after a fresh restart of the Viz Artist/Engine.

9.3.2 Configure Frame Accurate Output

To Configure Frame Accurate Output

1. Open **Viz Configuration**.

2. Select the [Communication](#) section and **enable Frame Accurate Viz Communication**.
3. Set **FAVC Bias** as needed. Delay fields (in addition to ringbuffer size) for frame accurate commands via TCP or GPI. This is the bias in frames for the commands if Frame Accurate Viz Command is turned on. Could be negative as well.
4. Set **FAVC Field Dominance** to `Odd Retrace Counter`. For FAVC Field Dominance you can set *Odd Retrace Counter* or *Even Retrace Counter*, where *Odd Retrace Counter* is the recommended option (except for NTSC).
5. Select the [Render Options](#) section and set the **RGB to YUV** setting to `Shader`. The following setting increases performance only when an X.mio is installed.
6. Select the [Video Input: Clip Input](#) section.
7. Expand the **ClipIn** settings for the clip channel you use and set **Video Delay DVE** to `0` and **Pending** to `Active`.
8. Click **Save** and **Close**.

9.3.3 Commands

To enable frame accurate handling of clips, it is necessary to preload the next scene by using the CUE command:

```
SCENE*<Scene Name> CUE
```

Because the loading time of clips is affected by disc speed and the used codec, allow at least a one second head start for the CUE command. The earlier you cue the next scene the more likely all of the clips are prepared when needed.

After the initial CUE command it is/could be necessary to send the following commands. If the scene was saved at another position than 0, send:

```
SCENE*<Scene Name>*STAGE SHOW 0.0
```

The following is always needed to finally set and activate the scene:

```
RENDERER SET_OBJECT SCENE*<Scene Name>
```

If the director is not configured to auto start you should use:

```
MAIN_SCENE*STAGE START
```

 **Note:** The first and last commands are optional.

9.3.4 General Purpose I/O Commands

Viz Engine can send and receive frame accurate commands via General Purpose input/output (GPIO), provided the following requirements are met:

- PCI or PCI Express Sealevel I/O device with eight, 16 or 32 digital inputs installed. Devices connected via Ethernet or USB cannot be used.
- Viz Engine 3.3 (rev 8394) or later to receive commands.
- Viz Engine 3.8.2 to send commands.
- A Matrox X.mio-series video board is required for getting the actual field which is played out.

This section contains information on the following topics:

- [Input Functionality](#)
- [Flow of the GPI signal](#)
- [Output Functionality](#)
- [Commands](#)
 - [Pin Command - Set](#)
 - [Command - Clear](#)
 - [Information - Get](#)
 - [Pin Command - Test](#)
 - [Enable - Set](#)
 - [GPO Command - Set](#)

Input Functionality

Currently, there are five commands available which enable you to queue commands for execution when a pin on the Sealevel board shows a raising or falling edge. For every Pin, an arbitrary amount of commands can be queued for the raising and falling event. Every command can be armed with a counter which tells Viz Engine how often the command should be executed before it is removed from the queue. A counter of 0 tells Viz Engine that the command should never be removed from the queue.

The following diagram illustrates the [Flow of the GPI signal](#) from the sender until the consequences of the executed command are rendered into the correct position in the Matrox ringbuffer. As soon as a **GPI sender** changes the status of a pin, connected to the **Sealevel device**, the change is reflected in an internal register of the card. In Viz Engine, a **thread** polls this register every millisecond. As soon as a change is found it calculates the timestamp for when the command should be executed.

The thread looks for the pin command in the **Command map** and queues the command into the **Timestamped commands** queue. As the actual depth of the Matrox ringbuffer, known the render loop, checks every field if it is time to execute a command from the queue. This guarantees that the command is executed at the correct field, no matter how large or full the ringbuffer actually is.

Flow of the GPI signal

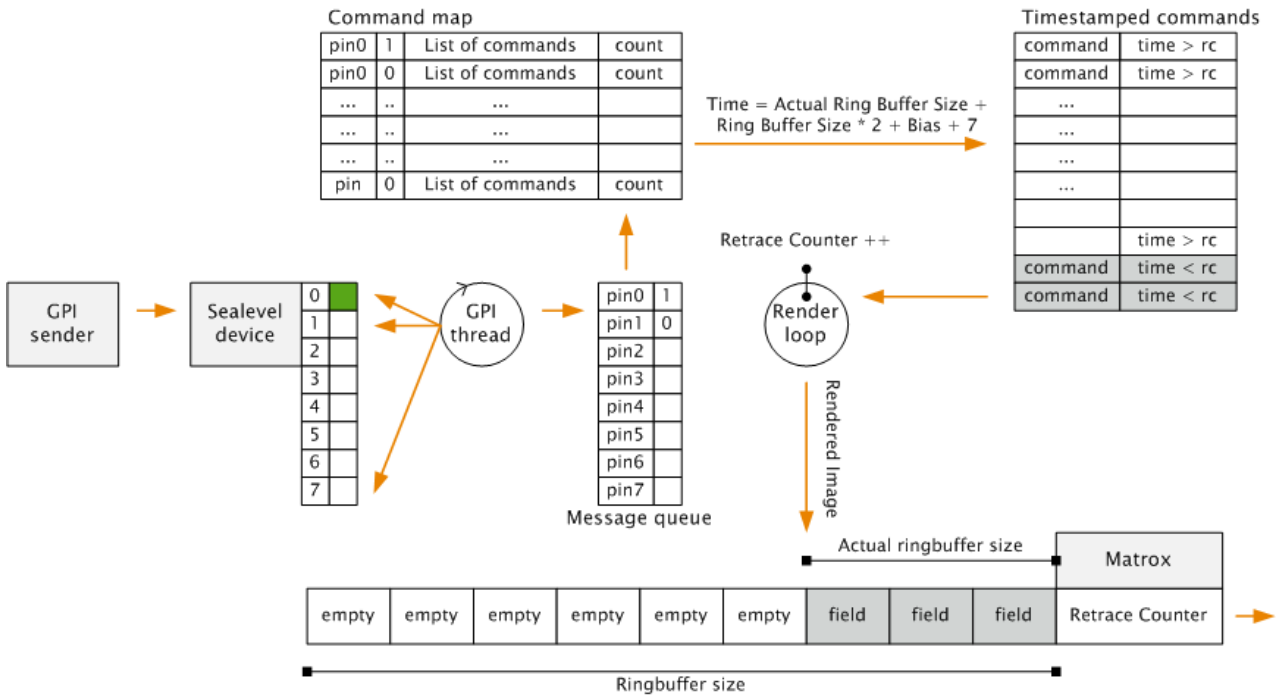

Output Functionality

Since version 3.8.2, Viz Engine is able to send external triggers via GPIO on systems with a supported Sealevel GPI/O card installed, using the [GPO Command - Set](#). Depending on the GPI/O card configuration in the Sealevel driver, the first configured output channel could reside in a higher bank. For example, bank 2 -> first channel = 16.

Note: Only one channel can be sent at a time.

Commands

The following are the available GPIO commands:

Pin Command – Set

```
VIZ_COMMUNICATION*GPI_PIN_COMMAND SET "<Command ID> <Command>" <PIN> <UP_DOWN> <COUNT>
```

Adds a command to the queue.

Example: VIZ_COMMUNICATION*GPI_PIN_COMMAND SET "-1 RENDERER*MAIN_LAYER*STAGE START" 0 1 0

- **<Command ID>**: The command ID specifier.
- **<Command>**: Command string which should be queued.
- **<PIN>**: Input pin number (valid from 0-31) where the first Pin is 0.
- **<UP_DOWN>**: 0 means the command should be executed on a falling edge, 1 means the command should be executed on a raising edge.
- **<COUNT>**: Executes the command <Count> times. The command executes once per event and NOT <Count> times per event. A value lower or equal to 0 means that the command is never removed from the queue.

Remarks: After the GPI event occurs, the execution time of the command is calculated. The execution time is calculated in the following

way: $\text{Ring_Buffer_Size} \times 2 + 7 + \text{Delayed_Command_Bias}$. The <Delayed_Command_Bias> can be set in the Viz Config file.

Therefore, $\text{Ring_Buffer_Size} \times 2 + 7$ is the minimum delay for GPI triggered commands.

Command – Clear

```
VIZ_COMMUNICATION*GPI_PIN_COMMAND CLEAR <PIN> <UP_DOWN>
```

Clears all commands from the queue.

- **<PIN>**: Input Pin number (valid from 0-31) where the first Pin is 0.
- **<UP_DOWN>**: 0 simulates a command executed on a falling edge, 1 simulates a command executed on a raising edge.

Information – Get

```
VIZ_COMMUNICATION*GPI_INFO GET
```

Sends information on the installed GPI device. If a valid device is present, the command returns the number of available GPI Banks. Therefore a value of 1 means that one bank (eight inputs) is available. If the command returns 0 no valid GPI device is present.

Pin Command – Test

```
VIZ_COMMUNICATION*GPI_PIN_COMMAND TEST <PIN> <UP_DOWN>
```

Sends all queued commands for the pin and signal to the Viz Engine. The counter for the commands is not decremented.

- **<PIN>**: Input Pin number (valid from 0-31) where the first Pin is 0.
- **<UP_DOWN>**: 0 means the command should be executed on a falling edge, 1 means the command should be executed on a raising edge.

Enable – Set

```
GLOBAL*GPI_ENABLE SET <1 or 0>
```

Enables or disables GPI commands for the Viz Engine. All functionality is available except of sending the commands on a GPI signal. If disabled, the command is shown in the console and a warning is shown, that GPI is disabled. The TEST command is working as usual, even if GPI is disabled.

- 1 enables GPI execution
- 0 disables GPI execution

GPO Command – Set

```
VIZ_COMMUNICATION*GPO_BIT SET <bit> <state>
```

Sets the specified output channel to either On or Off:

- 1 is On.
- 0 is Off.

The command can be sent directly via the Viz Engine command line, via an action keyframe, or DataPool plug-ins.

Example: send VIZ_COMMUNICATION*GPO_BIT SET 17 1

IMPORTANT! The bit count starts at 0.

9.3.5 Timed Command Execution

To achieve frame accurate output at a certain time, Viz Engine takes advantage of a time code reader board and special commands. Viz Engine records certain commands and executes them exactly at the time the time code reader board hits this timestamp.

Here, you find the following:

- [Time Code Related Commands](#)
- [Prerequisites](#)
- [Configuration](#)

Note: Frame Accurate Timed Command Execution in combination with graphics, live and clip playback requires Viz Engine version 3.9.1 or later. Earlier versions can only guarantee Frame Accurate Timed Command Execution on the Matrox X.mio2, X.mio2+ and X.mio3 (as X.mio2+) boards. Viz Engine can only guarantee a frame accurate output, not a field accurate one.

Time Code Related Commands

Time Code	Description
TC*TC_INFO GET	Gives you all available time codes in the system. The return is a list of indexes and strings. Every time code source is identified by a unique index.
TC*TC_ACTIVE GET	Gives all time codes which have been updated in the last two fields.
TC*TC GET <index>	Returns the time code for the index.
TC*USED_TC GET	Returns the current used timecode by index
TC*USED_TC SET	Sets the timecode source by index.
TC*TC_COMMAND SET_TC <index> <HH>:<MM>:<SS>:<FF> -1 COMMAND	<p>Queues a Command for execution on a specific time.</p> <p><index>: Index of the timecode. <HH>:<MM>:<SS>:<FF>: The timecode in Hours, Minutes, Seconds and Fields. <#>: Command answer identifier (currently only a value of -1 is supported). COMMAND: The Command to be executed.</p> <div style="border: 1px solid #ccc; padding: 5px; margin-top: 10px;"> <p>i Example</p> <pre>TC*TC_COMMAND SET_TC 1 12:07:10:00 -1 RENDERER SET_OBJECT SCENE*<9D1F7526-CFEF-C844-848279FE076E9104></pre> </div> <p>Activates scene <9D1F7526-CFEF-C844-848279FE076E9104> at exactly 12:07:10:00.</p>
TC*TC CLEAR <index>	Clears all queued commands for the time code source with index <index>.
TC*DELETION_THRESHOLD SET <TC>	<p>Defines a time frame after which a command is removed when it has not been executed. The threshold needs to be defined as hh:mm:ss:ff. <TC> is a valid timecode.</p> <div style="border: 1px solid #ccc; padding: 5px; margin-top: 10px;"> <p>i Example</p> <pre>TC*DELETION_THRESHOLD SET 00:00:10:00</pre> </div>

Time Code	Description
TC*ACTIVATION_THRESHOLD SET <TC>	<p>Defines a time frame until when a command has to be executed (even if the given timecode has already passed). The threshold needs to be defined as hh:mm:ss:ff . <TC> is a valid timecode.</p> <div style="border: 1px solid #ccc; padding: 5px; margin-top: 10px;"> <p>Example TC*ACTIVATION_THRESHOLD SET 00:00:00:10</p> </div>
TC*INSERT_THRESHOLD SET <TC>	<p>Defines a time frame into the future during which command are allowed to be executed when inserted. The threshold needs to be defined as hh:mm:ss:ff . <TC> is a valid timecode.</p> <div style="border: 1px solid #ccc; padding: 5px; margin-top: 10px;"> <p>Example TC*INSERT_THRESHOLD SET 01:00:00:00</p> </div>

Prerequisites

The following prerequisites need to be done:

- The system must be equipped with a Plura TC Reader board. This needs to be enabled in the Viz Config File by setting `TCReaderUsage = 1`.
- The correct TC source must be set by using `TCReaderSource`. Viz Engine supports LTC, VITC, ATC_LTC, ATC_VITC, HANC_LTC, HANC_VITC. To specify multiple sources the format would be: `TCReaderSource = LTC | VITC`.
- Commands need to be sent with a timecode. For example: `TC*TC_COMMAND SET_TC 1 12:00:00:00 -1 RENDERER*MAIN_LAYER SET_OBJECT SCENE*<9968FF26-35B0-4C01-AE5A4F8D11D1543B>`.
- Ringbuffer should be turned on. This makes sure that the command to load the given scene is executed exactly at the given timecode. (12:00:00:00).The fillsize of the ringbuffer is considered.

⚠ Note: To verify this, make sure the final output device (Recorder, Monitor) can display the same timecode as attached to the Viz Engine.

Configuration

To configure a correct field accurate timeout, a few parameters need to be set. Three important values are responsible for a proper playout of Graphics, DVE Live sources and DVE Clips:

Framebuffer Delay

The FramebufferDelay setting is usually used to delay the playout of any graphics. It is used to keep DVE and Graphics in sync when it is set to 0. However, for fine tuning the delays between Graphics, DVE Live and DVE Videos, this value needs to be adjusted accordingly.

For xMio3 boards, the Framebufferdelay can be set to 0. This makes sure all other delays are handled automatically, you need to fine tune your settings, the following settings are required.

Timed Command Bias

```
Command: TC*TC_BIAS SET n (in fields)
Config Setting: delayed_command_bias = n
```

This represents the overall delay in fields, the commands are sent if the time code hits the timestamp. This affects Graphics and any DVE source. For instance, if your graphics appear two frames too late, you need to use `delayed_command_bias=-2`.

Note: The Command `TC*TC_BIAS SET n` immediately takes effect for all TC commands sent after this one without restarting Viz Engine.

VideoIn[n]DelayDVE

If you also need to show DVE Live effects in a frame accurate environment, there is also the need to configure the delay of the LiveInput DVE. This is done by setting the following in the config file:

```
Matrox0.VideoIn1.VideoDelayDVE = n
```

This is the number of fields, the DVE signal is delayed until it is shown on the video output. This value can not be negative, the minimum is 1 (0 also represents 1). If your graphics + DVE are still too late, you need to decrease the timed command bias and adjust the VideoInDelay accordingly.

ClipIn[n]DelayDVE

If also clips need to be played exactly at the given timecode an additional parameter comes in play:

```
ClipIn1.VideoDelayDVE = n
```

This controls how many fields a clip is being delayed until it shows up on the Video Output.

Note: Clips need always to be cued as the need some time be read from the hard drive. This is done by sending the following command to the engine a few seconds before the scene is taken to air:

```
SCENE*<uuid> LOAD
SCENE*<uuid> CUE
```

Clips must be placed in the stage to be preloaded correctly.

The correct sequence to bring a scene On Air exactly at 12:00:00:00 with clips prepared would then be:

```
SCENE*<uuid> LOAD
SCENE*<uuid> CUE

TC*TC_COMMAND SET_TC 1 12:00:00:00 -1 RENDERER*UPDATE SET 0
TC*TC_COMMAND SET_TC 1 12:00:00:00 -1 RENDERER*MAIN_LAYER SET_OBJECT SCENE*<uuid>
TC*TC_COMMAND SET_TC 1 12:00:00:00 -1 RENDERER*STAGE START
TC*TC_COMMAND SET_TC 1 12:00:00:00 -1 RENDERER*UPDATE SET 1
```

X.mio2 Boards

For X.mio2 boards, following settings are needed:

Resolution	TC_BIAS Setting
1080i50	0
720p50	-1
PAL	+8
1080i60M	2
720p60M	0
NTSC	7

X.mio2+ Boards

For X.mio2+boards, following settings are needed:

Resolution	TC_BIAS Setting	DVE Delay Video	DVE Delay Clips	FramebufferDelay
1080i50	0	4	0	4
720p50	6	3	-	4
PAL	0	4	0	4

Resolution	TC_BIAS Setting	DVE Delay Video	DVE Delay Clips	FramebufferDelay
1080i60M	1	4	0	4
720p60M	6	3	-	4
NTSC	1	4	0	4

X.mio3 Boards

For X.mio3 boards, following settings are needed:

Resolution	TC_BIAS Setting	DVE Delay Video	DVE Delay Clip	FramebufferDelay
1080i50	0	4	0	0
1080i60M	0	4	1	0
720p50	0	4	0	0
720p60M	0	4	1	0

9.4 Shared Usage Of Input Channels

This feature allows two or more instances of Viz Engine on one system to show the same content by using the same physical input without the need for a distribution amplifier.

9.4.1 Configuration

To share the input, all instances must have their corresponding input channels configured the same to be used.

Example: `Matrox0.VideoIn1.MapToVizChannel = 0`

No further configuration is necessary.

9.4.2 Important

The first instance of Viz Engine that is started owns the physical connector of the input. All other instances started after share the content on the video board. If the first instance (in control of the input connector) is closed, all other instances referring to that connector lose their content as well, and need to be closed and restarted again. There is no automatic recovery when the owning instance of Viz Engine crashes.

Note: It is imperative that the first engine fully boots before the others can allocate the shared resource.

Watchdog configuration is also not supported in this case.

 **Info:** This feature is available on system topology boards only (xMio3, DSX.LE4 and successors).

9.5 Dynamic Channel Allocation

As of now, whenever you need an additional input or clip channel, you need to open the configuration, set the channel to the desired resolution on the Video Input page and restart the Engine. Only after that, the channel becomes available.

The dynamic allocation allows to dragging the resource from the Media Assets to your scene for immediate use. It uses the default values and the output resolution for configuration. If you need a different resolution for that specific channel, enter Video Input configuration, and select the resolution. The Media Asset can be used afterwards, without the need to restart the Engine.

9.5.1 Limitations

- Only dynamic adding of channels is supported at the moment. Removal is possible only by setting the channel to `Invalid` in the configuration, then restarting the Engine.
- The maximum number of channels has not changed.
- Dynamic allocation is only supported for inputs. Outputs cannot be acquired on demand.

 **Note:** This feature is meant to be used during design mode only!

9.6 Supported Matrox Codecs

The Matrox X.mio, X.mio2, X.mio2 Plus and X.mio3 video cards all support a selection of different codecs for both SD and HD. Depending on the class, a license upgrade may be required to extend the range of codecs supported by the installed video card. The Matrox video cards have a built-in license dongle used by the Matrox codecs to determine licensing rights. Certain codecs require certain card classes.

For the Matrox X.mio, X.mio2 and X.mio2 Plus video cards, the following classes apply:

- **6000 class:** SD codecs only. No D10
- **8000 class:** SD, HD, D10 and D12 codecs
- **8500 class:** SD, HD, D10 and D12 codecs, and Apple ProRes playback capabilities

For the Matrox X.mio3 and DSX LE 4 video cards, the following classes apply:

- **Class 100:** No clip playback
- **Class 500:** SD and HD clip playback
- **Class 550:** SD and HD clip playback, including support for Apple ProRes codecs

See Supported Codecs in the Viz Artist User Guide for a complete list of all supported codecs and formats.

 **IMPORTANT!** The Codec DNxHD requires its own license, issued by Vizrt.

All codecs are implemented in the software. For all full detailed overview, please refer the **Supported Codecs** page in the **Media Assets** section of the [Viz Artist User Guide](#).

9.7 Configuration History For Matrox X.mio And DSX Series

Viz Artist/Engine Version	Driver	Supported Hardware
3.13.0	DSX.utils 10.0.100.23773	X.mio3 IP, X.mio3, X.mio3 12G, X.mio2 Plus, X.mio2, DSX LE4, DSX LE3, m264
3.12.1	DSX.utils 9.9.1.23136	X.mio3 IP, X.mio3, X.mio3 12G, X.mio2 Plus, X.mio2, DSX LE4, DSX LE3, m264
3.12.0	DSX.utils 9.9.1.23136	X.mio3 IP, X.mio3, X.mio3 12G, X.mio2 Plus, X.mio2, DSX LE4, DSX LE3, m264
3.11.1	DSX.utils 9.9.0.23060	X.mio3 IP, X.mio3, X.mio3 12G, X.mio2 Plus, X.mio2, DSX LE4, DSX LE3, m264
3.11.0	DSX.utils 9.9.0.23060	X.mio3 IP, X.mio3, X.mio2 Plus, X.mio2, DSX LE4, DSX LE3, m264
3.10.0	DSX.utils 9.8.1.22400	X.mio3 IP, X.mio3, X.mio2 Plus, X.mio2, DSX LE4, DSX LE3, DSX LE2/CG
3.9.1	DSX.utils 9.8.1.22400	X.mio3 IP, X.mio3, X.mio2 Plus, X.mio2, DSX LE4, DSX LE3, DSX LE2/CG
3.9.0	DSX.utils 9.8.0.22358	X.mio3 IP, X.mio3, X.mio2 Plus, X.mio2, DSX LE4, DSX LE3, DSX LE2/CG
3.8.3	DSX.utils 9.7.0.21682	X.mio3 IP, X.mio3, X.mio2 Plus, X.mio2, DSX LE4, DSX LE3, DSX LE2/CG
3.8.2	DSX.utils 9.6.0.18841	X.mio3, X.mio2 Plus, X.mio2, DSX LE4, DSX LE3, DSX LE2/CG
3.8.1	DSX.utils 9.6.0.18836	X.mio3, X.mio2 Plus, X.mio2, DSX LE3, DSX LE2/CG

Viz Artist/Engine Version	Driver	Supported Hardware
3.8.0	DSX.utils 9.5.0.17766	X.mio3, X.mio2 Plus, X.mio2, DSX LE3, DSX LE2/CG
3.7.0	DSX.utils 9.4.0.9040 (release)	X.mio2 Plus, X.mio2, X.mio, DSX LE3, DSX LE2/CG
3.6.4	DSX.utils 9.2.2.2343	X.mio2 Plus, X.mio2, X.mio, DSX LE3, DSX LE2/CG
3.6.3	DSX.utils 9.2.2.2335 (SP2)	X.mio2 Plus, X.mio2, X.mio, DSX LE3, DSX LE2/CG
3.6.2	DSX.utils 9.2.2.2331 (SP2)	X.mio2 Plus, X.mio2, X.mio, DSX LE3, DSX LE2/CG
3.6.0	DSX.utils 9.2.2.2317 (SP2)	X.mio2 Plus, X.mio2, X.mio, DSX LE3, DSX LE2/CG
3.5.3 (see note below)	DSX.utils 7.5.2.1448	X.mio2, X.mio, DSX LE2/CG
3.5.0 - 3.5.2	DSX.utils 7.5.2.447 (SP2)	X.mio2, X.mio, DSX LE2/CG
3.3.x	DSX.utils 7.5.2.443	X.mio2, X.mio
3.2.2	DSX.utils 5.0.3.171	X.mio2, X.mio
3.1.0 - 3.2.1	DSX.utils 5.0.3.166	X.mio2, X.mio

9.7.1 Configuration History for Matrox X.Open

The Matrox X.Open uses the same driver as the Matrox X.mio series boards.

9.8 DVE Performance

This section contains information on the following topics:

- [General Information](#)
 - [Single Channel performance \(1080i50\):](#)
 - [Dual Channel performance \(1080i50\):](#)

9.8.1 General Information

The number of DVE channels that can be used in Viz Engine depends on the video hardware. The limiting factor is the amount of memory on the card, but also the available bandwidth for transfers between the FPGA and the on-board memory. For example, on a [Matrox X.mio 3 / DSX LE 4](#) card, you can scale eight 1080i surfaces to 99.9% and compose those eight surfaces at the same time. If the scaling factor is reduced, the overall DVE performance increases, due to the lowered amount of bandwidth needed. At a certain point, it might even be possible to add an additional DVE input. Looking at a single channel system fit with an X.mio3, nine inputs can be used as DVE, as one is always consumed by the background layer. However, setting the system up as dual channel, reduces the amount of DVE layers to three in each channel, considering that two background layers are used.

Single Channel performance (1080i50):

The maximum number of DVE Assets (excluding Fore- and Background layer) on **xMio2+**:

Size	Maximum
100%	6
99%	6
33%	6

The maximum number of DVE Assets (excluding Fore- and Background layer) on **xMio3**:

Size	Maximum
100%	9
99%	9
33%	10 (Break even point ~95%)

Dual Channel performance (1080i50):

The maximum number of DVE Assets (excluding Fore- and Background layer) on **xMio2+** for each single channel :

Size	Maximum
100%	2(3)
99%	2(3)
33%	3 (Break even point ~90%)

The maximum number of DVE Assets (excluding Fore- and Background layer) on **xMio3** for each single channel:

Size	Maximum
100%	4
99%	4
33%	4

Note: The asterisk (*) denotes measurements are done with DSX Utils 9.8.0.22112 on Viz Engine 3.9.0.66266.

9.9 Matrox Watchdog Configuration

A watchdog is essentially a timer that allows a system to continue video pass-through when an application has crashed or there is a system failure. The X.mio has a built-in watchdog capability; however, the bypass only works for video (including optional embedded audio), while AES audio is not bypassed. The watchdog can be used as a Mechanical Bypass (copper-to-copper) or a Hardware Bypass (default).

This section contains the following topics and procedures:

- [Mechanical Bypass](#)
- [Hardware Bypass](#)
- [Transition from Watchdog to Video](#)
- [To Enable Mechanical Bypass](#)

9.9.1 Mechanical Bypass

A relay (input to output) that works in case of a power loss. To use mechanical bypass see [To Enable Mechanical Bypass](#).

9.9.2 Hardware Bypass

Operates in a powered machine state (input to the board's output). In hardware bypass mode the incoming video and reference signals must be compliant to provide the correct watchdog functionality.

Tip: The hardware bypass introduces an h-phase on the output. The value of this phase depends on the video output format.

9.9.3 Transition from Watchdog to Video

When watchdog is deactivated (with `video_loopthrough_mode=2`) and a scene with DVE input is loaded, a few black frames are shown. The watchdog should be activated after the input channel is ready. To provide a glitch free transition from watchdog to video configure the watchdog's deactivation delay by setting the delay in fields for the watchdog to wait before deactivation.

9.9.4 To Enable Mechanical Bypass

1. Stop Viz Engine.
2. Open the Viz Config file (for example: *VIZ-<hostname>-0-0.cfg*).
3. Locate SECTION MATROX_CONFIG.
4. Enable the Matrox watchdog setting: `Matrox0.WatchDogUseHardwareBypass = 0`
5. Save the file.
6. Start Viz Engine.

10 Audio In Viz

This section contains the technical description of the Viz Engine audio system, and contains the following information:

- [Overview](#)
- [Device Recognition and Selection](#)
- [Timing Behavior and Delay Settings](#)
- [Channel Setup and Clip Channel Routing](#)
- [Audio Plug-in](#)
- [Clip Formats](#)
- [Speaker Names](#)
- [Matrox Audio](#)
- [Emergency Alert System](#)
- [Dolby E configuration](#)

10.1 Overview

There are two ways to capture audio in the Viz Engine, through Matrox or a DirectSound compatible device.

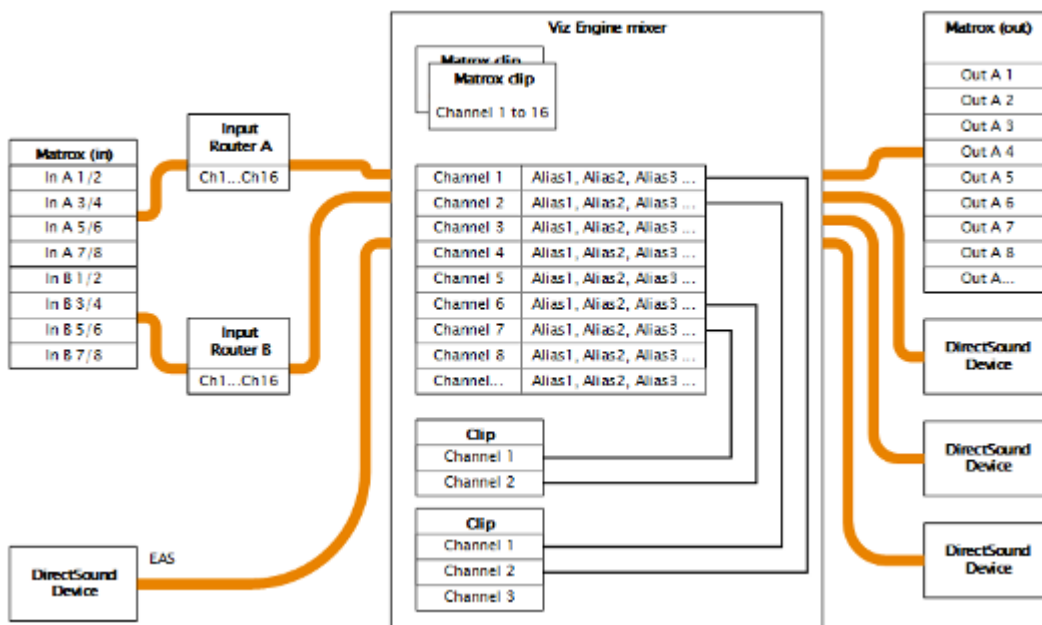

This page contains information on the following topics:

- [Channels](#)
 - [Audio Channels](#)
 - [Matrox Input Channels](#)
 - [Output Channels](#)
- [Matrox Routing](#)
 - [Matrox Live Input Routing](#)

- [Matrox Clip Routing](#)
- [DirectShow](#)
 - [DirectShow Filters](#)
 - [DirectSound Input](#)
 - [DirectSound Audio Card](#)

10.1.1 Channels

Audio Channels

Viz Engine handles up to 16 audio channels for both input and output. This corresponds to the maximum number of embedded audio channels on an HD-SDI video source. Every channel can be given one or more user-defined aliases.

Matrox Input Channels

If using Matrox video hardware, the 16 input channels are available as AES/EBU input or embedded audio.

Output Channels

After mixing, the Viz Engine writes the audio data to the available output devices.

10.1.2 Matrox Routing

Matrox Live Input Routing

On Matrox cards, it is possible to route live input channels to any internal Viz Engine output channel. Several channels can be routed to a single internal channel, but it is not possible to duplicate input channels.

Matrox Clip Routing

Audio from Matrox clips are mapped one by one to the internal Viz Engine channels; hence, no routing is possible. Audio from audio clips played through the stage is routed to the internal audio channel. This can be done automatic or manually.

10.1.3 DirectShow

DirectShow Filters

Viz Engine is able to play any audio file for which a DirectShow filter is installed. DirectShow provides a set of default filters that install automatically with Microsoft Windows. These filters support many data formats while providing a high degree of hardware independence.

All the filters supported by the DirectShow Software Development Kit (SDK) are listed on the Microsoft Developer Network (MSDN) website. If a filter appears in GraphEdit but is not documented by the MSDN on-line reference, it means the filter has either been installed by a third party or is used internally by some other Microsoft technology. Such filters are not supported by the DirectShow SDK.

DirectSound Input

Microsoft DirectSound provides a system to capture sounds from input devices and play sounds through various playback devices using advanced 3-dimensional positioning effects, and filters for echo, distortion, reverberation, and other effects.

A DirectSound compatible card is an alternative for designers that use laptops with no video card installed, or if analog audio is needed. Viz supports DirectSound compatible cards that support DirectX version 8 or later.

 **Note:** Matrox are only able to output digital audio.

DirectSound Audio Card

Viz Engine 3 is able to use any DirectSound capable dual-channel audio card installed in the system.

If a Matrox board is installed on the system, Viz Engine synchronizes the audio output of the DirectSound cards to the video sync signal coming in to the video card.

See Also

- [Channel Setup and Clip Channel Routing](#)
- [Device Recognition and Selection](#)

10.2 Device Recognition And Selection

The audio system is able to use any installed DirectSound capable audio device. On every device, up to 16 channels can be used.

- **Sample Rate:**Shows the sample rate. Default sample rate is 48kHz (48000) which is the maximum allowed. *Reserved for later use.*
- **Device *n*** : Shows the name of the audio card.
- **Bits per Sample:**Shows the number of bits used per sample. Default value is 16 Bit per sample rate. *Reserved for later use.*
- **Mode:** Refers to the audio mode of the Matrox board. Options are:
 - **Embedded:** Captures audio from the Live video input connectors and is made available to the Viz Engine audio mixer, to mix it with other audio sources. Then output as embedded audio on the live video output connectors.
 - **AES:** Captures audio from the AES input connectors and is made available to the Viz Engine audio mixer, to mix it with other audio sources. Then output on the AES output connectors.
 - **Embedded -> AES:** Captures embedded audio from the live video input connectors and is made available to the Viz Engine audio mixer, to mix it with other audio sources. Then output on the AES output connectors.
 - **AES -> Embedded:** Captures audio from the AES input connectors and is made available to the Viz Engine audio mixer, to mix it with other audio sources. Then output as embedded audio on the live video output connectors.
 - **Loop:** Loops audio through. No audio is mixed.
 - **Default:** Captures audio, but no output on the Matrox card.

During the startup process Viz Engine tests all available audio cards installed on the system. Manual activation of audio devices is done in **SECTION AUDIO_CONFIG** of the Viz Config file. By default a one to one channel assignment from the first audio device is done when a new device is selected.

10.3 Timing Behavior And Delay Settings

Timing behavior can only be set for each activated DirectSound. The default values should work for most devices; however, differences may occur between devices.

10.3.1 Latency Adjustment on the DirectSound Audio Device

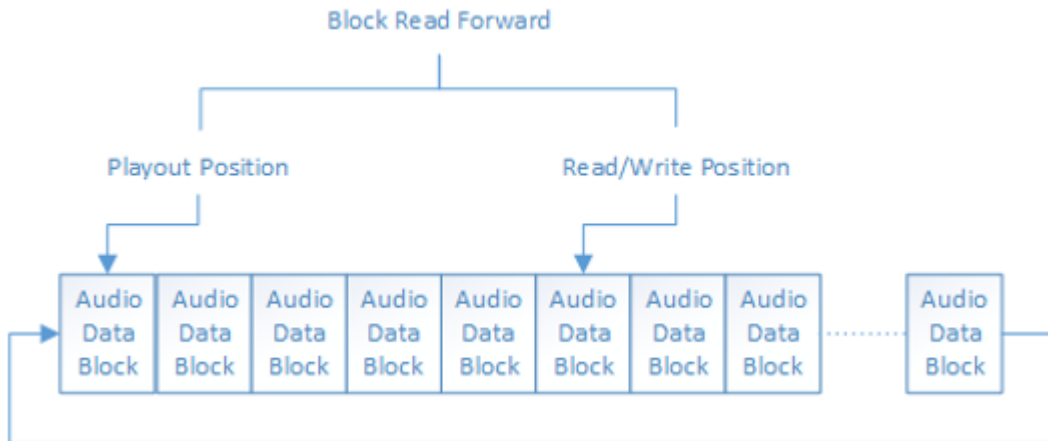

All sound devices use a ringbuffer that stores data until it is sent out to the audio channels, and this ringbuffer is organized in blocks of data. All sound hardware defines a distance in blocks (or bytes) that needs to be maintained. For almost all devices on the market a distance of six blocks is sufficient to have a clean output without artifacts.

✔ **Tip:** Try to decrease the *Block Read Forward* value down to 3 to accomplish less delay for the output. Viz Engine creates a ringbuffer of one second which is split in 60 blocks. This gives an output delay of ten milliseconds when the *BlockReadForward* value is 6 (see the Viz Config file's SECTION AUDIO_CONFIG).

⚠ **Note:** An audio card which is not synchronized always runs faster or than a synchronized video or audio card. There is a mechanism needed to keep all audio cards synchronized with each other. The mechanism, shown below, is used by Viz Engine to fulfill this condition:

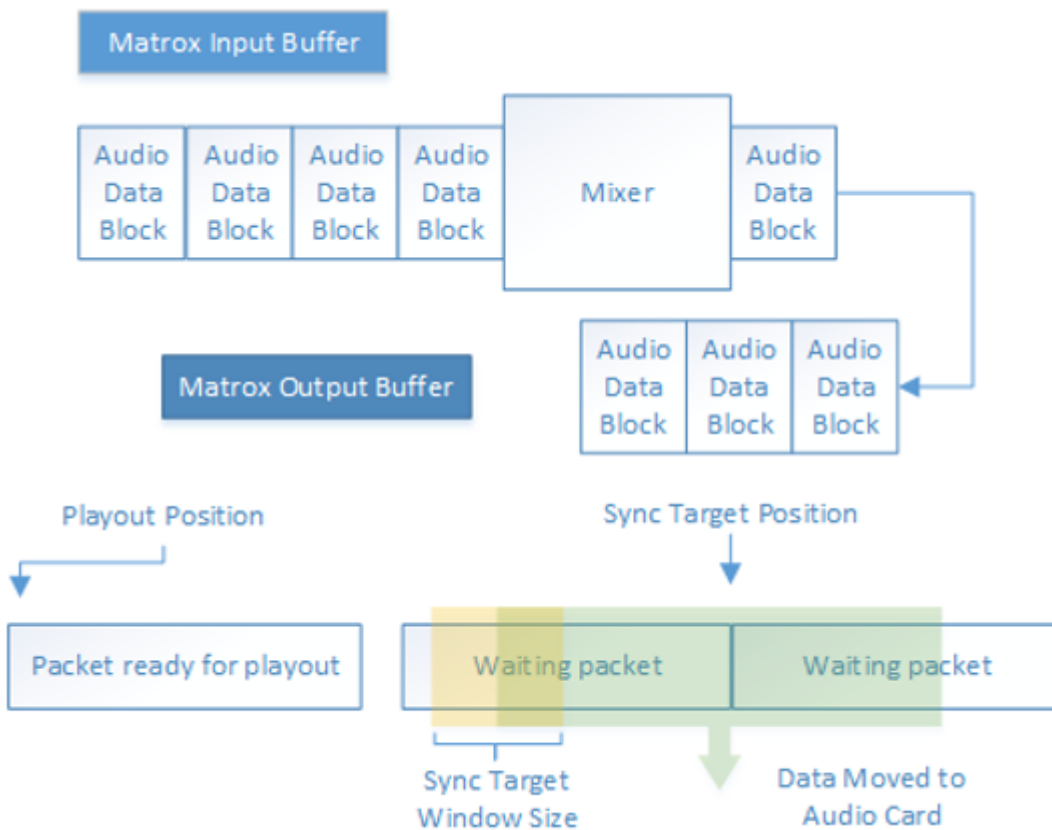

After mixing the packages received from the Matrox board, the blocks of audio data are moved to the Matrox output buffer. This buffer is organized as a ringbuffer and holds one second of data and this is the maximum delay that can be achieved with the described mechanism.

The `SyncTargetPosition` parameter, set in `SECTION AUDIO_CONFIG`, defines the position relative to the playout position of the Matrox board where the audio data for the direct sound cards are branched. If the card is running slower than the reference card, the synchronized position moves away from the playout position. If it is faster, `SyncTargetPosition` moves to the playout position. The `SyncTargetWindowSize` parameter defines the border, when Viz Engine starts to re-sample the DirectSound data to bring `SyncTargetPosition` back in place. The predefined value of 250 samples is a good compromise between performance and quality. If a cheap audio card is used and small artifacts can be heard, try to increase this value. Good ranges are from 250 up to 600.

`SyncTargetPosition` is used to synchronize the different audio cards to each other. Every audio card shows a specific delay behavior. Increase or decrease this value if one card is faster than the other. If the value is too small, artifacts occur; however, most audio cards work fine with the predefined values. `SyncTargetPosition` and `SyncTargetWindowsSize` are configurable settings that can be set separately for every activated audio card.

Channel Device and Channel Track settings

In Viz Engine, it is possible to combine two or more devices for playout of the Viz Engine's internal audio channels. Note that Viz Engine internally can use up to 16 channels. On many professional multichannel cards the channels are organized in virtual devices with two channels. A good example is the following configuration:

```
Available2 = M-Audio Delta 66 1+2
Available3 = M-Audio Delta 66 3+4
```

In Viz Engine it is possible to combine these two devices and create a quad speaker configuration as shown below:

```
VIZChannelDevice0 = M-Audio Delta 66 1+2
VIZChannelDevice1 = M-Audio Delta 66 1+2
VIZChannelDevice2 = M-Audio Delta 66 3+4
VIZChannelDevice3 = M-Audio Delta 66 3+4
VIZChannelDevice4 = Realtek HD Audio output
VIZChannelDevice5 = Realtek HD Audio output
VIZChannelDevice6 = Realtek HD Audio output
VIZChannelDevice7 = Realtek HD Audio output
VIZChannelDevice8 = none
VIZChannelDevice9 = none
VIZChannelDevice10 = none
VIZChannelDevice11 = none
VIZChannelDevice12 = none
VIZChannelDevice13 = none
VIZChannelDevice14 = none
VIZChannelDevice15 = none
VIZChannelTrack0 = 0
VIZChannelTrack1 = 1
VIZChannelTrack2 = 0
VIZChannelTrack3 = 1
VIZChannelTrack4 = 4
VIZChannelTrack5 = 5
VIZChannelTrack6 = 6
VIZChannelTrack7 = 7
VIZChannelTrack8 = 0
VIZChannelTrack9 = 0
VIZChannelTrack10 = 0
VIZChannelTrack11 = 0
VIZChannelTrack12 = 0
VIZChannelTrack13 = 0
VIZChannelTrack14 = 0
VIZChannelTrack15 = 0
```

See Also

- The Viz Config file, **SECTION AUDIO_CONFIG**.

10.4 Channel Setup And Clip Channel Routing

Channel setup is configured in the [Audio Settings](#) section in Viz Configuration. To get a correct mixing of clip channels, to the Viz Engine internal channels it is important to set the audio channels in a correct way.

The [Audio Settings](#) section of Viz Configuration is used to configure audio channels and channel routing, and [To Add Multi-language Audio Channels](#). The latter allows the same scene with the same audio clips to output English, German, French and background music on three different machines. It is also possible to create 3D and other channel configurations for as many environments as needed. Stereo is configured by default.

From Viz Artist, a scene designer is able [To Add Multiple Audio Channel Configurations](#), test the audio channel setup, and switch between the different local setups matching for example one or several remote Viz Engine audio setups. Configurations can also be tested separately or all together.

10.4.1 To Test Audio Channel Setup

1. Start Viz Artist.
2. Create a new Scene.
3. Add a group container to the Scene Tree.
4. Add the [Audio Plug-in](#).
5. Open the Audio plug-in editor.
6. Add an audio clip to the *Test Clip* drop-zone.
7. Click **Play**.

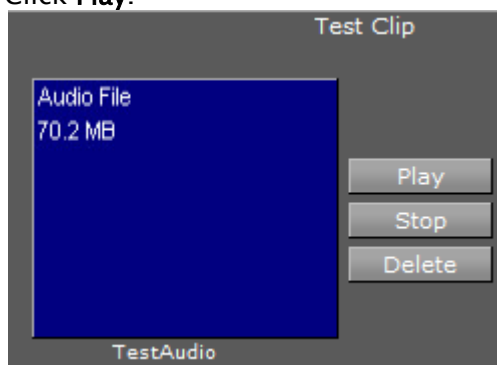

✓ **Tip:** Always have a set of test clips that provide audio for the different channel setups.

10.5 Audio Plug-In



The Audio plug-in allows a designer to configure audio channels.

Go to **Audio** in Container Plugins (see the Container Plugins section of the [Viz Artist User Guide](#)), for more information on the Audio plug-in.

This plug-in is located in Viz Artist (**Built-ins > Container Plugins > Global**) and can be applied to any container.

10.6 Clip Formats

The recommended audio format is WAVE, as it gives the least decoding time and the best performance. Additionally, it is the only format that matches the Viz Engine support for 16 channels.

Video clips can have interleaved audio in it. The format is limited to 24bit and 48khz. There needs to be at least two channels in it, as mono is not supported. Again, the maximum channels are 16.

SDI in, break-out box (BOB) out is supported as well as BOB in and SDI out. It can be controlled by the video/clip channels controls.

Viz Engine is able to import and play the following Formats:

- **WAVE:** Up to 96kHz, 24Bit and 16 Channels.
- **MP3:** All Formats (Stereo only).
- **OggVorbis:** All Formats, up to 16 Channels.

See Also

- [Audio Settings](#)
 - [Matrox configuration](#)
-

10.7 Speaker Names

Viz Engine understands the following default speaker names:

- *FRONT_LEFT, FRONT_RIGHT and FRONT_CENTER*
- *LOW_FREQUENCY*
- *BACK_LEFT, BACK_RIGHT, and BACK_CENTER*
- *FRONT_LEFT_OF_CENTER and FRONT_RIGHT_OF_CENTER*
- *SIDE_LEFT and SIDE_RIGHT*
- *TOP_CENTER, TOP_FRONT_LEFT, TOP_FRONT_CENTER, TOP_FRONT_RIGHT, TOP_BACK_LEFT, TOP_BACK_CENTER and TOP_BACK_RIGHT*
- *SPEAKER_RESERVED*

See Also

- [Audio Settings](#)
 - [Matrox configuration interface](#)
-

10.8 Matrox Audio

The Matrox card is able to use up to 16 channels for capture and playout. The audio can be embedded into the video signal or be an external signal through the AES/EBU connectors. The available AES/EBU connectors depend on the Matrox version.

On the X.mio cards, there are balanced 75 Ohm connectors. On newer cards, 110 Ohm connectors are used.

10.8.1 To Enable Matrox Audio

1. Open **Viz Config**.
2. Click on **Audio Settings**.
3. In the **Various** tab, set either, or both, **Enable embedded audio on Live1** or **Enable embedded audio on Live2** to on. This must be done for AES/EBU audio as well.
4. Click on the **Setup** tab.
5. Set a **Mode**. Select from:
 - Embedded
 - AES
 - Embedded AES
 - AES Embedded
 - Loop
6. Click on **Matrox**.
7. Select **VideoIn A** or **VideoIn B**
8. In the **Audio** section:
 - Set **Audio** to *Active*.
 - Set the required **Channels**.
 - Set the required **Delay**.

 **Tip:** Use the provided configuration templates for a proper Audio Video delay. These templates are stored in **C:\Program Files\Vizrt\Viz3\Configuration Profiles**, you can easily access them by clicking on **Load** and **Installed Profile**.

9. Click **Save**.
10. Close **Viz Config**.

10.9 Emergency Alert System

The Emergency Alert System (EAS) is a national warning system used in the United States that supersedes the Emergency Broadcast System (EBS) and the CONELRAD System. EAS is jointly coordinated by the Federal Communications Commission (FCC), Federal Emergency Management Agency (FEMA) and the National Weather Service (NWS). The official EAS is designed to enable the President of the United States to speak to the citizens of the United States within ten minutes.

In Viz Engine, the analog audio input through the DirectSound device is reserved for the Emergency Alert System (EAS) for broadcasters in the United States of America. If the EAS is activated, all audio is muted, and the source from the first analog audio card installed in the system is played through the **Matrox** board. The behavior is supported with the Text-to-Speech plug-in, as well as audio clips which are recorded prior to sending. These clips can be added dynamically. Viz Engine then adds them directly into predefined audio channels and also mute the other channels.

10.9.1 To specify output channels for EAS

1. Open **Audio Settings** and select the **Channels** tab.
2. In the **Out Channel** list, enter the keywords **EAS0** and **EAS1** for the left and right channels, respectively. If either keyword is used in any channel, explicit mapping is used.

Several output channels may be pointed to by the same EAS channel. If no explicit mapping is set, Viz Engine defaults to output channels zero and one. Empty mapping is not allowed for the EAS system.

10.10 Dolby E Configuration

This section explains how to consistently set up a Viz Engine for use with the DolbyE audio codec.

- [Enable DolbyE](#)
- [Prepare for DolbyE Decoding](#)
- [Prepare for DolbyE Encoding](#)
- [Decode Plus Encode](#)
- [Pass-through Mode](#)

Note: We use zero-based channel numbering in this configuration (channels zero through 15).

One most important prerequisite is a dongle containing a license from Minnetonka, the firm which makes the Surcode encoder/decoder SDK. You must have audio setup for 16-channel embedded mode in Viz. The inputs containing a DolbyE stream should also be configured for 16-channel, or at least 8-channel, depending on how many other audio channels are in the SDI audio track.

10.10.1 Enable DolbyE

There is one global flag for this in the Viz config file, this must be set for decoding or encoding.

```
DolbyEEnabled = 1
```

10.10.2 Prepare for DolbyE Decoding

DolbyE uses two audio channels on input. These channels must be a contiguous pair (i.e. 0/1, 2/3, 4/5, or 6/7). On the transmit side SDI audio does work mainly with audio pairs, as well as groups. The decoded data is always eight channels, and is always written to the upper eight channels, eight through 15.

You must specify two pieces of information:

- The video channel (which live input to use).
- The first audio channel in the pair.

For the first:

```
ChannelDolbyEnabled__0 = 1 // video live input 1 contains the DolbyE data, or
ChannelDolbyEnabled__3 = 1 // video live input 4 contains the DolbyE data
```

For the second, you specify the first channel in an audio pair:

```
ChannelDolbyPos__1 = 4 // video live input 2 contains the DolbyE data on channels 4/5
```

The channels containing the DolbyE stream are muted on output. E.g., if your input consists of PCM audio on channels 0-5, and DolbyE data on channel 6-7, you get 14 channels of audio on output (given no other audio routing settings):

```
0 = input 0
1 = input 1
2 = input 2
3 = input 3
4 = input 4
5 = input 5
6 = silence - dolby data is muted
7 = silence - dolby data is muted
8 = decoded 0
9 = decoded 1
10 = decoded 2
11 = decoded 3
12 = decoded 4
13 = decoded 5
14 = decoded 6
15 = decoded 7
```

10.10.3 Prepare for DolbyE Encoding

In this case, we go from eight channels of PCM audio to two channels for the DolbyE stream. For input to the Dolby code, you can choose from two banks of eight channels: the lower eight (zero through seven) or the upper eight (eight through 15). The config field:

```
DolbyEOutput = 0 // No encoding
DolbyEOutput = 1 // Encode the lower eight, 0..7
DolbyEOutput = 2 // Encode the upper eight, 8..15
```

For output, you must give the first audio channel in a pair, which contains the DolbyE stream, for example:

```
DolbyEMixInPosition = 4 // goes out on channels 4/5
```

10.10.4 Decode Plus Encode

It is possible to perform a scenario which uses both encoding and decoding.

10.10.5 Pass-through Mode

There are settings which enables a DolbyE data stream to go through the Viz audio mixer untouched. Normally, if you send integer data through the mixer, the bits are changed on output, as the mixer uses floating point math, with a conversion on input and output. This renders the DolbyE stream unusable. The DolbyE data goes through the audio mixer unconverted to floating point along the way.

```
ChannelDolbyEEnabled__0 = 1
ChannelDolbyEPos__0 = 0
ChannelDolbyEEnabled__1 = 1
ChannelDolbyEPos__1 = 2
ChannelDolbyEEnabled__2 = 1
ChannelDolbyEPos__2 = 4
ChannelDolbyEEnabled__3 = 1
ChannelDolbyEPos__3 = 6
ChannelDolbyEEnabled__4 = 1
ChannelDolbyEPos__4 = 8
ChannelDolbyEEnabled__5 = 1
ChannelDolbyEPos__5 = 10
ChannelDolbyEEnabled__6 = 1
ChannelDolbyEPos__6 = 12
ChannelDolbyEEnabled__7 = 1
ChannelDolbyEPos__7 = 14
DolbyEOutput = 0
DolbyEEnabled = 1
DolbyEMixInPosition = 0
DolbyELoop = 1
```

 **Note:** For a simple pass-through no Dolby dongle is required.

11 Shared Memory (SHM)

A local `VizCommunication.Map` in each Viz Engine (as part of a cluster), collects and stores data. This data can be internal data, like a scene script pushing data to the map, or data from external control applications through TCP or UDP.

This section contains information on the following topics:

- [External Data Input](#)
- [Internal Data \(Interactive Scene\)](#)
- [Synchronization](#)
- [Snapshot](#)

See Also

- [Data Sharing](#) (see the [Viz Artist User Guide](#))
-

11.1 External Data Input

Data fed into the Shared Memory (SHM) should be done through the dedicated UDP or TCP IP ports for the SHM. Vizrt provides a set of components, *SendToSMM*, to make this task easier.

 **Note:** Go to `<Viz Install Directory> > Tools > SendToSMM`, for more information about `SendToSMM`.

Data can also be sent to SHM through a Command Interface. Data sent through the Command Interface may be seen as a good option because the data would need to be sent to one Viz Engine only, and this Viz Engine would then distribute the data to the other Viz Engines. But data sent to SHM through the Command Interface has problems:

- Data sent through the Command Interface blocks the render queue of the receiving engine causing potential frame drops. Since the data needs to be sent through a command significant more bytes are transferred over the network.
- This Viz Engine is also a single point of failure.
- The data arrives at this one Viz Engine sooner than on all other Viz Engines.
- The notification method of the Graphic Hub Manager is used to distribute the data and can cause additional load for the Graphic Hub Manager.

The preferred method to send data is to use the *SendToSMM* library (or an equivalent) to send the data to the individual Viz Engines.

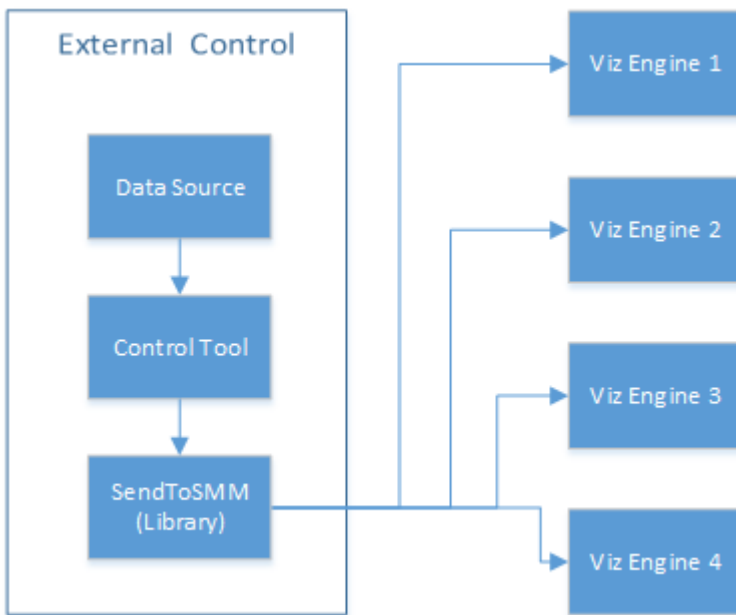

The communication protocol for the import of Shared Memory data depends on the type and final output of the data. There are set protocols to use with large amounts of data, in which all of the data must reach its destination graphic, and also where large amounts of data must be received quickly, but some loss of data is acceptable.

⚠ Note: It is also possible to import data through Multicast. This method is not recommended as it can pollute the network.

This page contains information on the following:

- [SHM over TCP](#)
 - [To Use TCP for SHM](#)
- [SHM over UDP](#)
 - [To Use UDP for SHM](#)
- [Plug-in API](#)
 - [Command Interface](#)
 - [Command Examples](#)

11.1.1 SHM over TCP

The SHM TCP communication protocol guarantees a reliable delivery of packages. It is a much more efficient than the [Command Interface](#), but not as fast as [SHM over UDP](#).

Use cases for a TCP connection could be finance stocks and currencies, or election result information, where the requirement is to deal with large amounts of information, and all of this data must reach its destination graphic. A single piece of lost data can have economic consequences, falsify charts, show mathematically wrong results, etc.

A TCP connection to a Viz Engine can be held open for a long time (this is recommended), and should not be closed and reopened between sending variables.

Note: The default maximum number of TCP connections is limited to 255. Within this number of connections, a user defined limit of maximum connections can be set in the [Communication](#) section of Viz Configuration.

IMPORTANT! The external program which provides the data, must connect and send the data to each Viz Engine individually. Vizrt provides a C# library, *SendToSMM* (part of the Viz install), for this purpose.

To Use TCP for SHM

Global		Shared Memory	
Multicast Ip Address	224.2.2.2		
Multicast Port	0	▲▼	R
UDP Port	0	▲▼	R
TCP Port	0	▲▼	R
Debug	Inactive		
Master Engine Ip Address			
Master Engine Port	0	▲▼	R
Master Poll	Inactive	Commands	UDP
			TCP

1. Go to the [Configuring Viz](#).
2. Click on [Communication](#).
3. Click on the **Shared Memory Properties** tab.
4. In the Shared Memory Panel, set **TCP Port**. There is no specific recommended port. Always make sure that the selected port is not in use by any other program on the same subnet.
5. Click **Save**.

The syntax for the key-value pairs is:

- key|value\0

Multiple key-value pairs can be sent, at once, as well. To do this make sure that each pair is terminated with 0.

- key1|value1\0key2|value2\0key...

11.1.2 SHM over UDP

The SHM UDP communication protocol should be used for the delivery of volatile data. It is quicker than the [SHM over TCP](#) protocol, but less reliable, and is much more efficient than the [Command Interface](#).

A use case for UDP would be Motor Sports, where data like speed, velocity, etc., is required. This is where there is a requirement to deal with large amounts of data, but not all of this data must reach its destination. A single piece of lost data does not affect the constant data update.

To Use UDP for SHM

Global		Shared Memory	
Multicast Ip Address	224.2.2.2		
Multicast Port	0	▲▼	R
UDP Port	0	▲▼	R
TCP Port	0	▲▼	R
Debug	Inactive		
Master Engine Ip Address			
Master Engine Port	0	▲▼	R
Master Poll	Inactive	Commands	UDP

1. Go to the [Configuring Viz](#).
2. Click on [Communication](#).
3. Click on the **Shared Memory Properties** tab.
4. In the Shared Memory Panel, set **UDP Port**. There is no specific recommended port. Always make sure that the selected port is not in use by any other program on the same subnet.
5. Click **Save**.

The syntax for sending key-value pairs is the same as for [TCP and UDP Synchronization](#).

11.1.3 Plug-in API

An option to manipulate data in SHM is by a plug-in interface. A use case would be where a TCP or UDP connection can not be used, or is not to be used. It is possible to write a plug-in to import data (e.g. from an XML file, another database, etc.) and push it to SHM.

Another use case would be an interactive Scene (see [Internal Data \(Interactive Scene\)](#)).

Note: The Plug-in API documentation is included with the Viz installation (go to **Start > All Programs > Viz Artist x.x > Plugin SDK Documentation > Classes > Class List > SHARED_MEMORY**).

Command Interface

For small and single value changes the Command Interface of Viz Engine can be used. For example, to update a headline in a Scene.

IMPORTANT! A command operation can block the renderer. If there are too many commands, within a small time, or commands containing a large amount of data, are sent, this can result in not rendering real-time anymore.

Note: Vizrt do not recommend this as a method for data import.

Any external program should consider the performance of the single or all connected Viz Engines. If there is a burst of thousands of SHM variables this can have implications on the Viz Engine rendering performance (Current (CUR) and Maximum (MAX)). A full list of commands is located at `<viz install folder>\Documentation\CommandInterface\index.html`

Note: From the list of commands, the commands, CLEAR, DELETE_ELEMENT and PURGE_ELEMENT only works when sent through the command interface of Viz Engine.

IMPORTANT! The command CLEAR must be run on each Engine where the MAP is to be reset (VIZ_COMMUNICATION*MAP CLEAR).

Whenever a new entry is made in the map (a new key-value pair) or values are changed, then the change is propagated to the other Viz Engines through a database messaging service to update the local copy of each Viz Engine's map (this only works when sent over the general communication port of Viz Engine. The default port is 6100).

Command Examples

VIZ_COMMUNICATION*MAP can be used to access the map.

```
SET_DOUBLE_ELEMENT and GET_DOUBLE_ELEMENT
```

Example: VIZ_COMMUNICATION*MAP SET_DOUBLE_ELEMENT "my_double" 1.2

Example: VIZ_COMMUNICATION*MAP GET_DOUBLE_ELEMENT "my_double"

11.2 Internal Data (Interactive Scene)

When data is modified on the distributed shared memory map on one Viz Engine through a script or through a plug-in, the data change gets reflected on the other Viz Engines automatically if they are configured to listen to the same shared memory map key. A use case could be a touch screen scene which modifies data, which is also used for HD-SDI Viz Engines or Viz Engines driving a Video Wall.

This synchronization uses Graphic Hub Manager as a relay. Therefore, it is important that all Viz Engines which are to receive the data are connected to the same Graphic Hub Manager, which use the same user or at least the same group.

11.2.1 Example

```
sub OnInit()  
VizCommunication.Map.RegisterChangedCallback("game")  
end sub  
  
sub OnSharedMemoryVariableChanged(map As SharedMemory, mapKey As String)  
if mapKey="game" then  
dim val = VizCommunication.map["game"]  
println "new value:"+val  
end if  
end sub
```

If you now change the value of "game" on any of the connected clients running a scene with the above script, all engines should print the new value into the console window.

11.3 Synchronization

If a Viz Engine is restarted or added to the cluster of Viz Engines for playout, the *VizCommunication.Map* data is not available on this Viz Engine. The local map on a new or restarted Viz Engine can be synchronized with the local map on another running Viz Engine in the same cluster.

A start-up Viz Engine can be synchronized through:

- TCP
- UDP
- An External Control Application
- Commands

i Example: If Viz Engine 1 restarts it looks to Viz Engine 3 to update its local *VizCommunication.Map*.

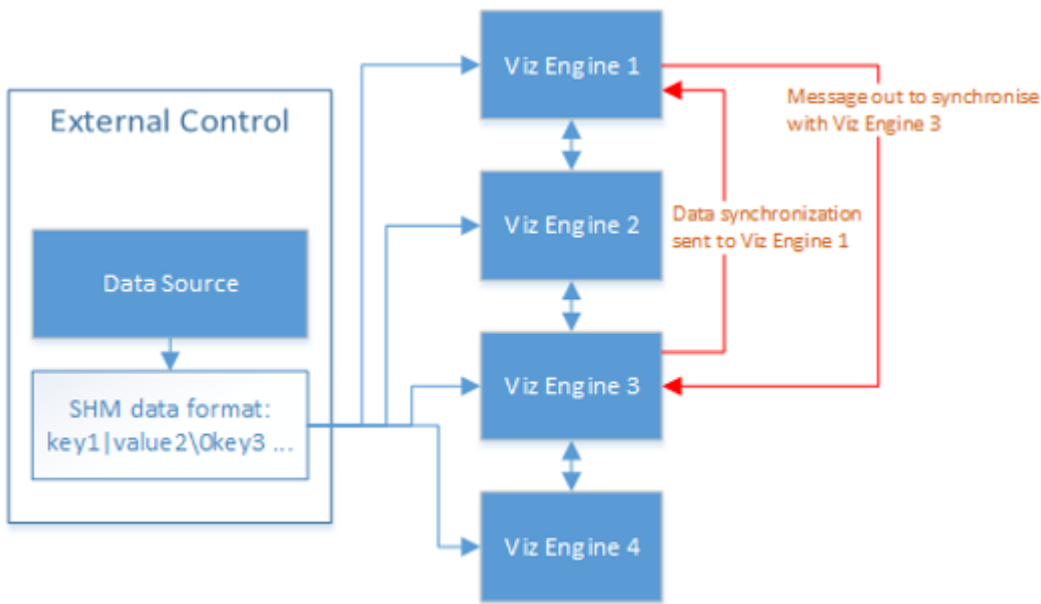

This section contains information on the following topics:

- TCP and UDP Synchronization
 - To Synchronize a Viz Engine with TCP or UDP
- External Control Synchronization
 - From a Command Interface
 - Through TCP Communication
 - Through UDP Communication
- Command Synchronization
 - To synchronize a Start-up Viz Engine with Commands

11.3.1 TCP and UDP Synchronization

Use the procedure detailed below to synchronize a restarted or added Viz Engines, in a cluster, with the TCP or UDP protocol:

- **TCP:** The recommended communication protocol to synchronize maps on start-up because it is reliable and efficient (see [SHM over TCP](#)).
- **UDP:** For fast communication, but has drawbacks. For instance, packets can get lost (see [SHM over UDP](#)).

To Synchronize a Viz Engine with TCP or UDP

1. Go to [Viz Configuration](#).
2. Click on [Communication](#).
3. Click on the **Shared Memory Properties** tab.
4. Enter the TCP or UDP port number.

Note: Always make sure that the selected port number is not in use by any other program on the same subnet.

5. In **Master Engine IP Address** type the IP address of a running Viz Engine to synchronize with. Example *<IP/hostname of Viz Engine 3>*.

Note: Must be the IP address of a running Viz Engine in the same cluster system.

6. In **Master Engine Port**, type the port number to be used (default 6100). This port sends the single startup synchronization command to start synchronizing. It should be the same as the general communication port of the Viz Engine set in **Master Engine IP Address**.
7. In **Master Poll**, select **UDP** or **TCP** as selected in step 4.
8. Click **Save**.

11.3.2 External Control Synchronization

Synchronization can also be done from an External Control Application. The following command has to be sent to the Viz Engine which has the memory map populated:

From a Command Interface

```
VIZ_COMMUNICATION SYNCHRONIZE_TO <engine port>
```

where the Viz Engine is the engine which receives the data through the Command Interface. The port is usually 6100 (standard command interface port).

Note: This is not recommended as a method for synchronization.

Through TCP Communication

```
VIZ_COMMUNICATION SYNCHRONIZE_SMMTCP <engine port>
```

where the Viz Engine is the engine which receives the data, and the port is the one that was specified for incoming TCP key/value pairs on the Viz Engine which is to receive the data (see [SHM over TCP](#)).

Through UDP Communication

```
VIZ_COMMUNICATION SYNCHRONIZE_UDP <engine port>
```

where the Viz Engine is the engine which receives the data, and the port is the one that was specified for incoming UDP key/value pairs on the Viz Engine which is to receive the data (see [SHM over UDP](#)).

11.3.3 Command Synchronization

Another communication option is by Commands. Here each map entry is synchronized through commands. It is reliable, but very slow and blocks the engine for quite an amount of time, if the map is large.

Note: This is not recommended as a method for synchronization.

To synchronize a Start-up Viz Engine with Commands

1. Go to [Viz Configuration](#).
2. Click on [Communication](#).
3. Click on the **Shared Memory Properties** tab.
4. In the Shared Memory panel set these parameters:
 - **Master Engine Port:** Enter the communication port of the Master engine (default is 6100).
 - **Master Poll:** Click on **Commands**.
5. Click **Save**.

11.4 Snapshot

It is also possible to take a data snapshot (save the whole content of the map) at any time. One Viz Engine can save the whole content of the map by calling the map's *SaveToDb* procedure, and another client can read it by calling *LoadFromDb*. The downside of this approach is that these

functions block the renderer and can cause poor performance of the Graphic Hub Manager database, if the map is stored repeatedly.

! **IMPORTANT!** The resulting SHM map objects are replicated as well. So saving the map each field or every minute can result in serious problems for the Graphic Hub Manager database (replication failing, etc.).

! **Note:** For more information see the script function documentation. Go to, **Start > All Programs > Viz Artist x.x > Script Documentation > Data Types and procedures > Shared Memory**, or **<Viz Install Directory> > ScriptDoc > DataTypeSharedMemory**.

See Also

- [External Data Input](#)
- [Synchronization](#)

12 Video Wall Configuration

Viz Engine supports output to multiple monitors configured as one large screen, commonly referred to as a video wall. This section details the hardware and software requirements, and how to configure Viz Engine to use a Video Wall.

Viz Engine video walls are based on the NVIDIA Mosaic technology for multiple displays, in an array of configurations. This allows for resolutions as high as up to 16k by 16k from one Engine, fully synchronized with the house sync signal, with displays in landscape, portrait or arbitrary rotation layouts at the same time.

Please take a look at the [Troubleshooting](#) section prior to setting up NVIDIA Mosaic for the first time, as it provides solutions for common issues that may arise during Mosaic setup.

This chapter contains information on the following topics:

- [Hardware Requirements and Recommendations](#)
 - [Performance Considerations](#)
 - [Video Wall Setup Instructions](#)
 - [Troubleshooting Video Wall Configurations](#)
-

12.1 Hardware Requirements And Recommendations

This section has information on the following topics:

- [Minimum Hardware Configuration for Video Walls](#)
- [Recommended Configuration for Video Walls](#)

The decision about which hardware to use when setting up a video wall depends a great deal on how the video wall can be used. In the most basic sense, any multi-display setup can be used. However, when in need of an increased number of displays, clip playback capabilities, live streams, or complex graphics, the demands on the hardware increases significantly. A video board is required for clip playback and input capabilities.

Utilizing the NVIDIA Quadro M6000 or P6000 graphics cards and the Matrix X.mio3 video board, Viz Engine support video wall configurations with up to 16k by 16k output resolution, and up to eight SDI inputs. Depending on the selected configuration, Viz Engine currently supports the following inputs and outputs for video walls:

- Four to eight SDI inputs, with resolutions ranging from SD to 4K, with a maximum of eight 1080i or one 4K concurrent input.
- Four to 16 DisplayPort or DVI outputs, with up to 4K resolution per output.

 **Note:** More GPUs require more bandwidth and therefore decrease the performance. Therefore, it is strongly recommended to use only one physical GPU and split the outputs (4*4K on M6000/ 4*5K on P6000) with additional hardware like a Datapath Device.

12.1.1 Minimum Hardware Configuration for Video Walls

- HP Z800-series Desktop Workstation

- NVIDIA Quadro M4000 graphics card
- Matrox X.mio2 video board with optional X.RIO expansion module
- NVIDIA Quadro Sync synchronization card

12.1.2 Recommended Configuration for Video Walls

- HP Z8 Desktop Workstation
- NVIDIA Quadro M6000 or P6000 graphics card
- Matrox X.mio3 or Matrox DSX LE4 video board
- NVIDIA Quadro Sync synchronization card

 **Note:** Videowall configurations require a DVI Max Resolution license.

12.2 Performance Considerations

For maximum performance, the hardware described in the Recommended Configuration for Video Walls section should be used. In addition, the Engine should be running without GUI. To do this, start Viz Engine with the following command line options:

```
<viz install folder>\viz.exe -n -w
```

12.2.1 Hardware Considerations

As Viz Engine operates in real time, rendering the output field by field, a wide range of factors may influence performance. Each field is rendered within 20 or 16.67 milliseconds, depending on the output format being 50 Hz (PAL) or 59.94 Hz (NTSC), respectively. This means that any requirements added to the render process reduces the time available for rendering the final output. Such requirements can be, but is not limited to:

- Copying between GPUs on a multi-GPU system.
- Copying between CPUs on a multi-CPU system.
- The system bus transfer rate on the system's motherboard.
- The amount of data to be copied and finally rendered.

In other words, adding more GPUs to the system decreases the overall performance, because of the time required for copying information between the GPUs. Therefore, in configurations with multiple graphics cards, the cards should be connected to the same CPU (refer to the motherboard specifications). As a result, single GPU setups are *always* recommended over multi-GPU setups for performance reasons. By adding the [Datapath Fx4](#) display wall controller, a 4K signal can be split into 4 HD signals. This allows to run, for example, a video wall with a total of 16 displays on one M6000 graphics card, with four Datapath Fx4 units.

On a multi-CPU system with two graphics cards, assigning them both to the same CPU can increase performance with as much as 30 percent.

12.2.2 Scene Design Considerations

When designing scenes for a video wall, the design and graphics should be tested on the actual video wall. The scenes can be tested on computer monitors as well, in which case the monitor layout should preferably be as close to that of the video wall the scenes are being designed for, even down to make and model. This is to avoid different configurations, as well as the look and feel of the test configuration.

For the best result, performance tests should always be performed on the actual video wall before taking a new scene on air.

In Viz Artist 3.8.2, the resolution of GFX Channels is by default set to the configured output resolution. To increase performance, limit the GFX channel resolution to the maximum resolution needed, for example 1920 x 1080 for HD resolution. The resolution setting depends on the scenes to be shown and how memory intensive they are.

In multi-GPU configurations, GFX Channels should be added as Texture rather than DVE assets, as the performance improves significantly.

12.3 Video Wall Setup Instructions

This section has information on the following topics:

- [Pre-Requirements for All Setups](#)
- [Configure the NVIDIA Driver for Video Wall](#)
- [Order of Steps to Set Up NVIDIA Mosaic](#)
- [NVIDIA Quadro Sync](#)
 - [To Check the Status LEDs of the G-Sync Device](#)

Additional information:

- [Multiplay Troubleshooting Guide](#)
- www.datapath.co.uk for Datapath Devices.

It is recommended to use only one GPU. Using more than one GPU results in a performance drop. If you are required to use more than one GPU, make sure that the monitor cables are the same for all cards. For example, a video wall configuration with six monitors on two cards, should use three outputs on each card with the same connectors on each card. If required, adapters can be used to connect the displays to the machine.

Make sure the NVIDIA G-SYNC card receives the same reference signal as the video board:

 **Info:** A G-sync board is always required, no matter how many GPUs are installed.



12.3.1 Pre-Requirements for All Setups

1. Shut down the machine.
2. Install the graphics device, NVIDIA G-Sync board and Matrox X.Mio board. Please refer to the related documentation included with the hardware. For multiple CPU setups with two graphics devices, make sure that both devices are on the same CPU.

⚠ IMPORTANT! Nvidia GPUs must be installed using the 8-pin power adapter which is included with the card. Installing the card using a 6-pin power connector has a negative impact on performance and can lead to unexpected system behavior with reports of a PCI error.

3. Connect the NVIDIA G-Sync and Matrox X.Mio to the Genlock source. When attaching the connector cables between the graphics card and the G-SYNC card, make sure that the red line on all of the connector cables are facing the card's mounting bracket, towards the back of the case. Failure to do so can result in synchronization issues.
4. Connect the Matrox X.Mio video input and output jacks.
5. Connect one monitor only to the graphics card, for the initial setup.
6. Boot the machine.
7. Install NVIDIA drivers and Matrox DSX.Utils. Reboot the machine as required.

8. Shut down the computer and connect all remaining video wall displays to the graphics card. For configurations with more than one graphics card, make sure to use the same outputs on all cards.
9. Boot the machine and proceed with the [Order of Steps to Set Up NVIDIA Mosaic](#).

12.3.2 Configure the NVIDIA Driver for Video Wall

1. Using the standard NVIDIA settings for Viz Engine, change the following parameter: **Vertical Sync:** On.
2. Apply the changes, then select **3D App - Video Editing** from the profile drop-down menu, and apply changes again:

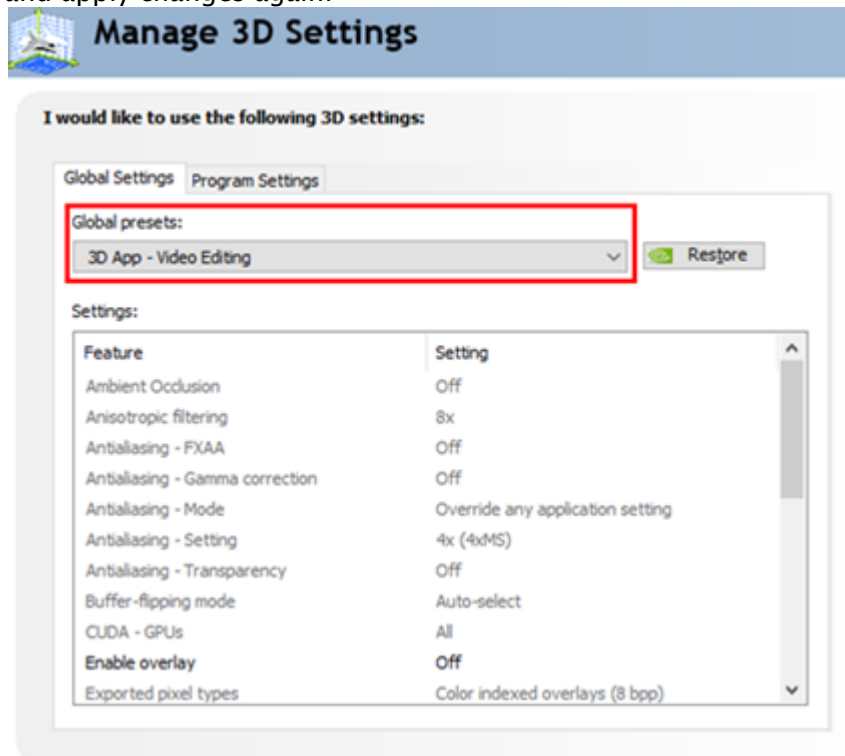

12.3.3 Order of Steps to Set Up NVIDIA Mosaic

Please take a look at the [Troubleshooting](#) section prior to setting up NVIDIA Mosaic for the first time, as it provides solutions for common issues that may arise during Mosaic setup.

IMPORTANT! For 50 Hz setups, make sure that there is no **EDID-file** loaded. Then start the Mosaic configuration, there is no need to perform more steps. For 59.94 Hz, load the EDID-file and make sure it is applied properly by verifying every single monitor in the **View System Topology** panel.

If running with two or more cards, make sure the same outputs are used on each card. For example, if using two DisplayPort outputs and one DVI output on the first card, the same outputs must be used on the second card, etc. Failure to do so may result in Mosaic setup failure, with an error message stating that the configuration is not supported.

1. Enter Mosaic configuration in the NVIDIA control panel and setup Mosaic for the required refresh rate:
 - [NVIDIA Mosaic Configuration for 1080i50](#)
 - [NVIDIA Mosaic Configuration for 1080i60M](#)
2. Synchronize the GPU to the internal house-sync, by configuring the NVIDIA G-Sync device in the **Synchronize displays** panel of the NVIDIA Control Panel:
 - [NVIDIA Quadro Sync](#)

Proceed with adjusting the [Viz Engine Video Wall Configuration Settings](#) to finalize the video wall configuration.

12.3.4 NVIDIA Quadro Sync

The NVIDIA Quadro sync card is used to synchronize the graphics cards with the house clock, and is required for video wall configurations.

V-sync must still be set in the NVIDIA driver to ensure that the OpenGL SwapBuffer operation takes place at the vertical retrace, to avoid tearing between two frames. The Quadro Sync board synchronizes the vertical retrace of all the displays, it does not lock the OpenGL SwapBuffer operation to the vertical retrace.

To Check the Status LEDs of the G-Sync Device

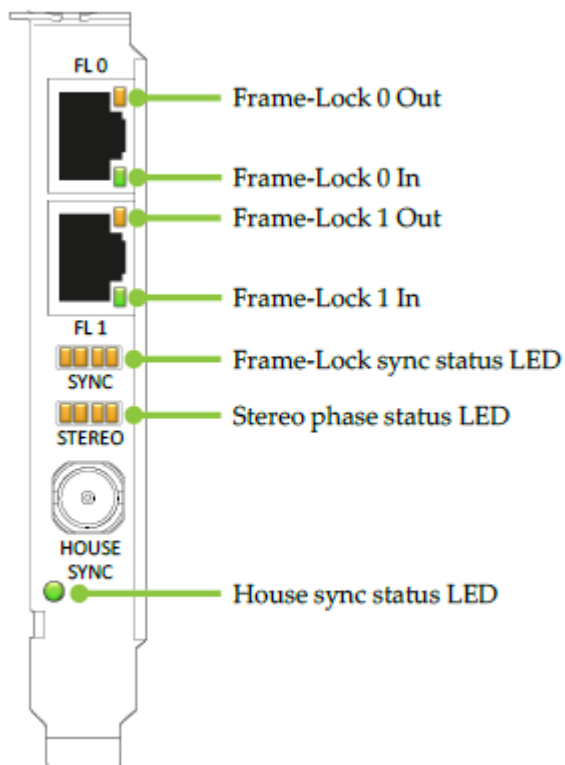

1. Ensure the House sync status LED indicates that a proper sync signal is connected.
2. Ensure that the Frame-Lock sync status LED is shining green. It must not blink or shine orange. When sync is stable, the Stereo phase status LED should also be lit green.

12.3.5 Configuration Using Datapath Devices

This section has some basic information on how to configure a videowall using [Datapath devices](#):

- [Prepare the Layout](#)
- [Prepare the Input](#)
- [Attach the Device\(s\)](#)
- [Troubleshooting](#)

For detailed instructions on how to use these devices, please refer to <https://www.datapath.co.uk/datapath-user-guides>.

A Maxwell or Pascal GPU supports up to 4K (5K Pascal) resolution per head. This allows for a maximum resolution of 16Kx16K on one GPU. As single GPU installations are preferred for performance issues one can utilize a multi display distributor from Datapath to grab the incoming signal and split it up into four individual HD signals. A single head drives four HD outputs, four heads can drive up to 16 HD outputs. The Datapath devices are recognized by the nVidia driver as one single monitor with its full resolution. Additionally, each Datapath device can be synced on a house signal, usually the same sync used for synchronizing the GSync board and the Matrox devices.

Please follow these steps to setup a videowall based on Datapath devices. It is recommended to perform each of the following steps one after the other:

- Prepare the Datapath environment.
- Setup nVidia Mosaic.
- Synchronize your Mosaic.

Bezel correction

A bezel correction needs to be done on Datapath side, as the nVidia driver only sees one big display and is not aware of any bezel information.

Prepare the Layout

Choose your monitor vendor and add the number of screens you want to utilize.

Please make sure the resolution is the correct native resolution of your monitors and the refresh rate matches your final refresh rate (50Hz or 59.94Hz). After that, press **Add Monitors to Wall** button. This represents the physical alignment of your monitors. Perform any modification of your alignment in this screen.

 **Note:** You can also rotate and flip monitors within this view.

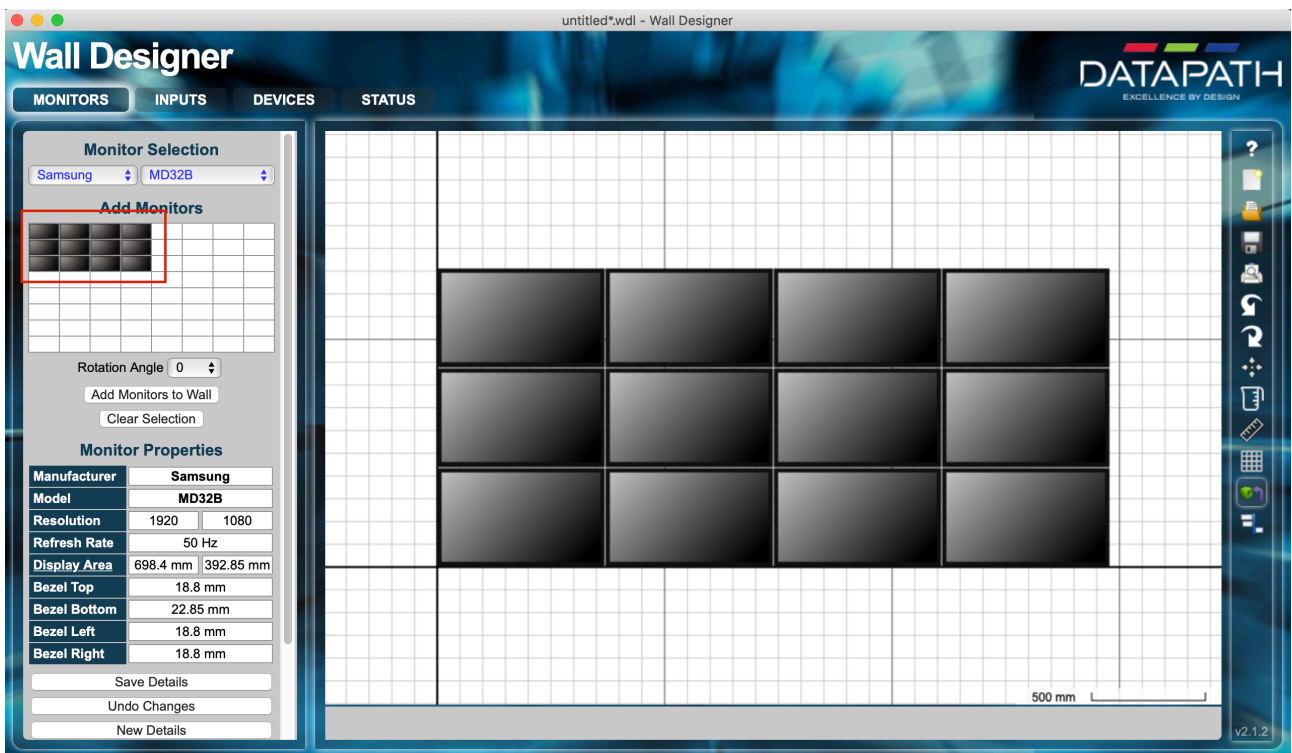

Prepare the Input

In this step, we create a virtual device recognized by the nVidia GPU as monitor(s). Create as many inputs as heads (=Datapath devices) physically connected to your nVidia GPU. In our example, we use three devices, each one of them is driving one row. One input is 4x1920px and 1080 pixels height. The input needs to be configured to be 7680px * 1080px. This is the same resolution as nVidia needs to recognize them.

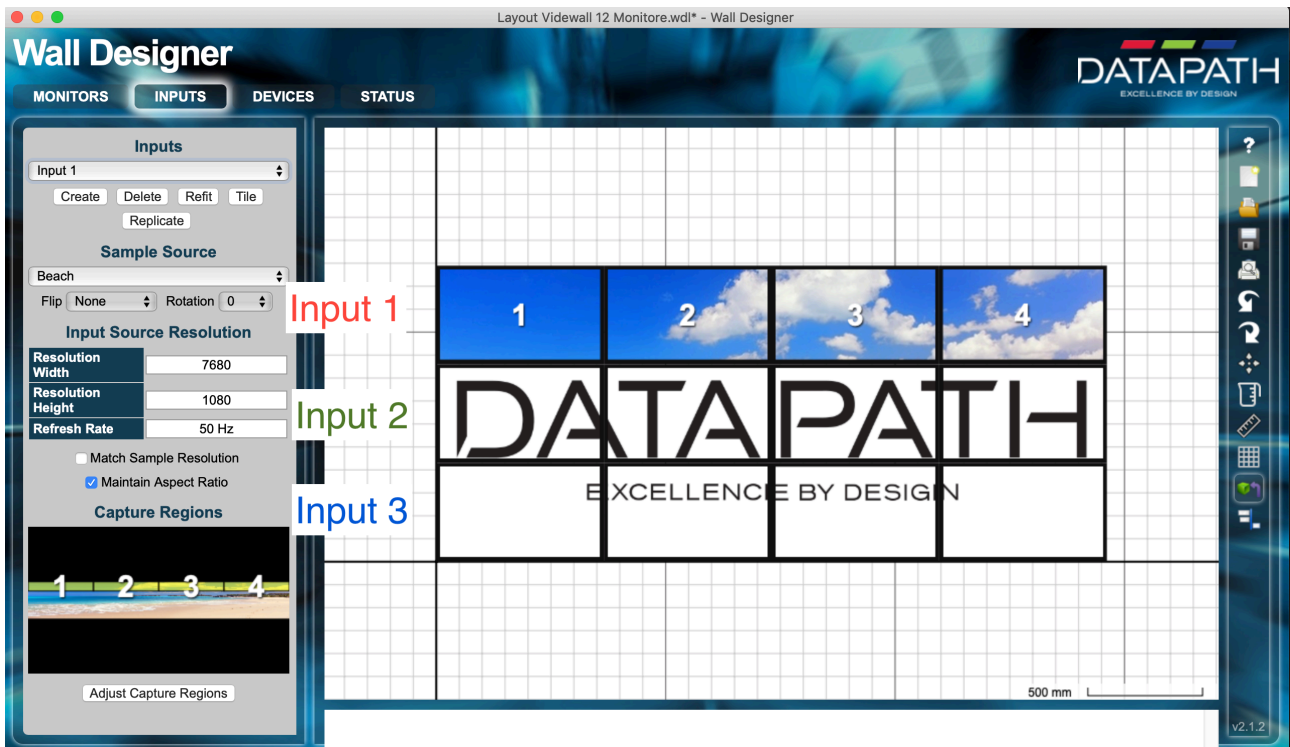

Press **Adjust Capture Regions** if you need to adjust the area the input captured by the various monitors. The alignment of monitors can be fine tuned pixel accurate. Any bezel correction needs also be done here. Make sure the displays align correctly to the configured input.

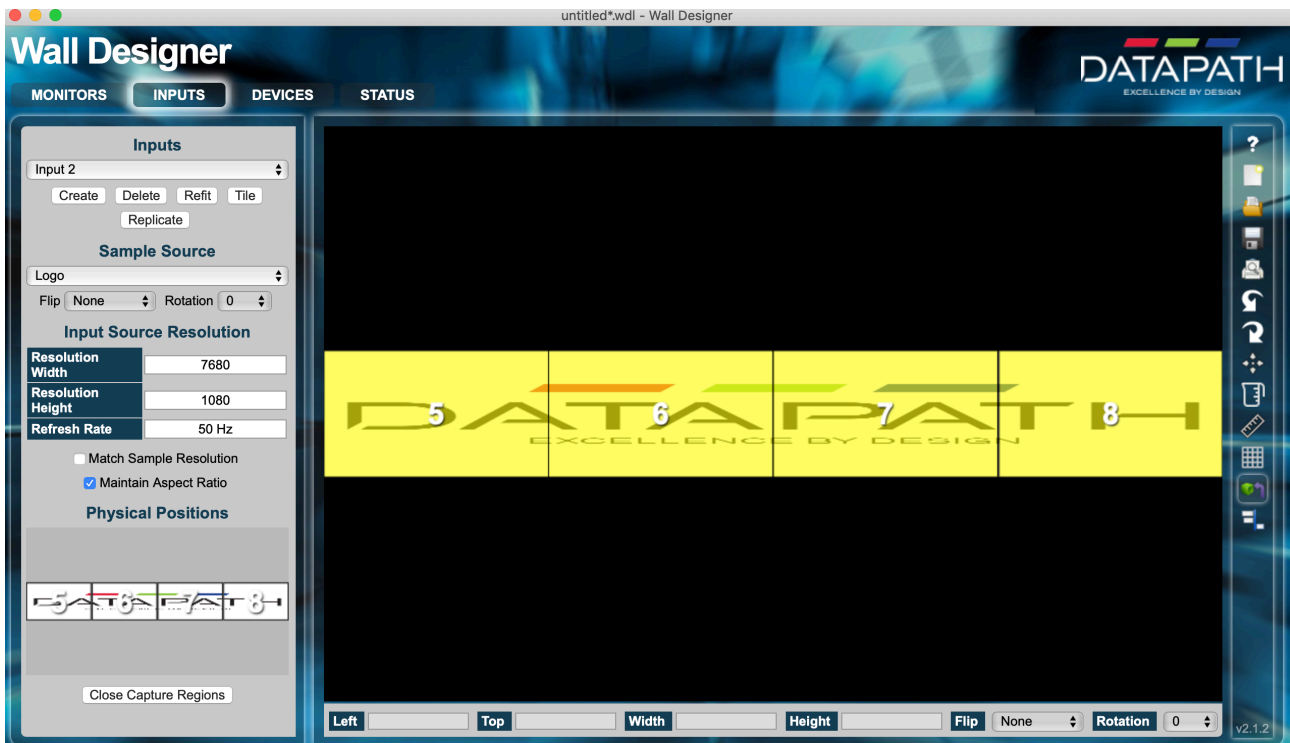

Attach the Device(s)

We need to connect the input to our physical Datapath devices. This is done in the devices section of Wall Designer. If you hit the **Auto Configure Device** on your current device, it generates an input, a Datapath device and the number of monitors. Now, we need to assign the Datapath devices to the one available. Make sure your environment discovered all your Datapath devices either on the network or connected via USB. This can be done in the status page. If no devices are present, they must be added manually.

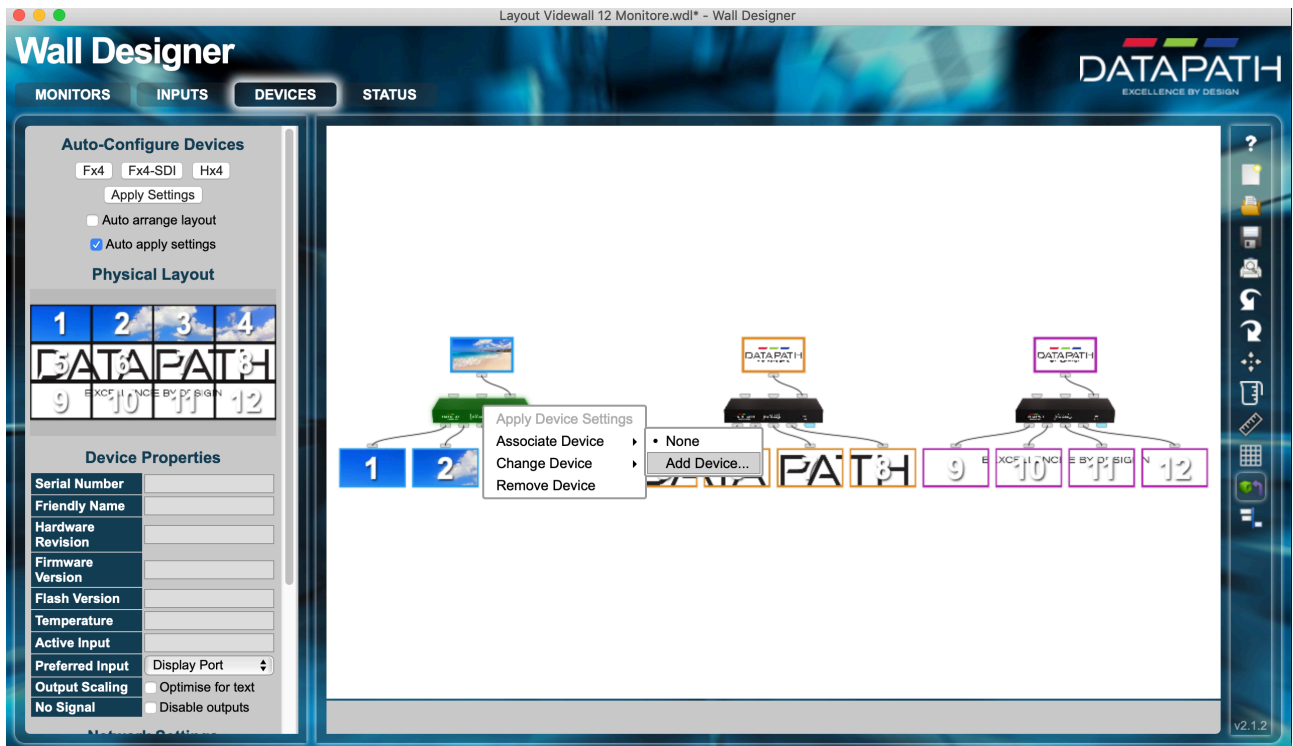

Right click on the **Datapath** and assign the correct one. If it is missing from the list, please manually add the IP number of your device. (This can be obtained by connecting it via USB). Once you click on the **Apply Settings** button, the configuration activates and the nVidia should recognize three virtual monitors with a resolution of 7680x1080 each. Verify the input by clicking on the input image(s). Once this step has been completed, you can continue by creating your nVidia mosaic:

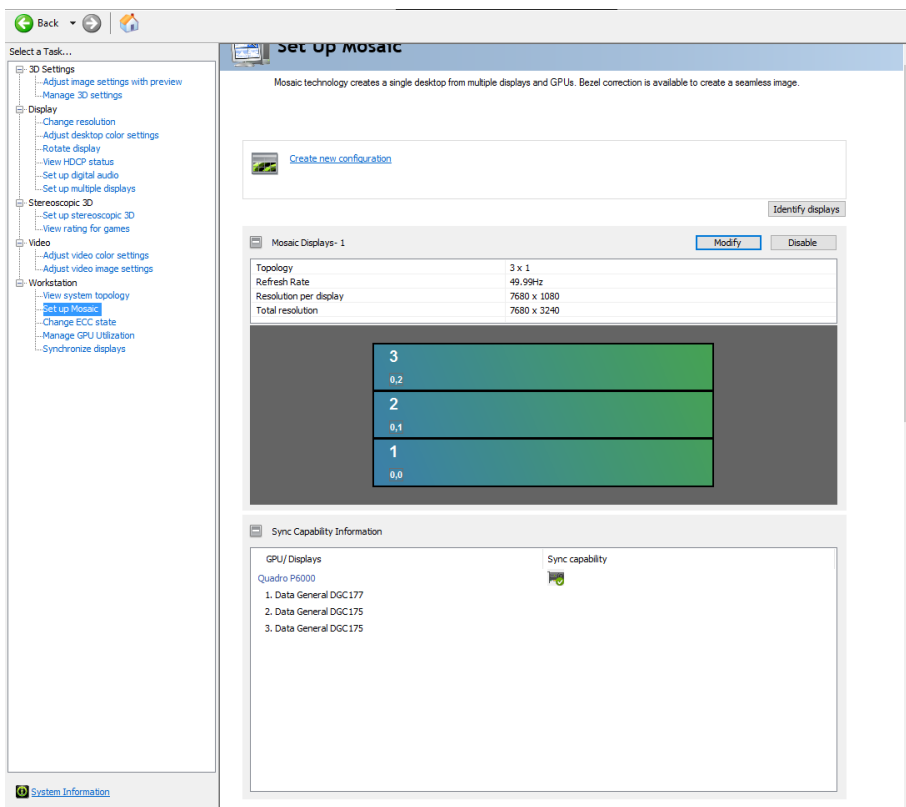

Troubleshooting

Detailed setting of each Datapath device is available by opening its built-in webpage. It allows setting proper name, network settings, correct timing and most important correct sync settings. Open the webpage and verify the correct timing for the sync and the refresh rate for each monitor. It can also display a test pattern instead of the nVidia output, which makes troubleshooting much more easier. If monitors remain black, but give a proper image when using a test pattern, verify in the nVidia control panel by checking the color depth per display. It must be set to eight bits/pixel, not six bits/pixel.

12.3.6 Custom Resolution for 59.94 Hz Refresh Rate

Video-wall displays may not natively support a refresh rate of 59.94 Hz. Such displays *always* require an **EDID-file** to be able to run at that frequency. Contact the display hardware vendor to obtain the correct EDID file for the monitors in use. Furthermore, a number of steps must be carried out before initiating the [NVIDIA Mosaic Configuration for 1080i60M](#).

This section contains information on the following topics:

- [To Load an EDID File](#)
- [To Create a Custom 59.94 Hz Resolution](#)
- [To Change from 59.94 Hz to 50 Hz Refresh Rate](#)

- ⚠ **Caution:** Loading unsupported or corrupted EDID settings for a display may render the source device unable to output any video signal to the display. Please refer to the information supplied by the display hardware vendor for information on the displays capabilities or limitations.

To Load an EDID File

1. In the **NVIDIA Control Panel**, expand the **Workstation** section of the **Select a Task...** menu and click **View system topology**:

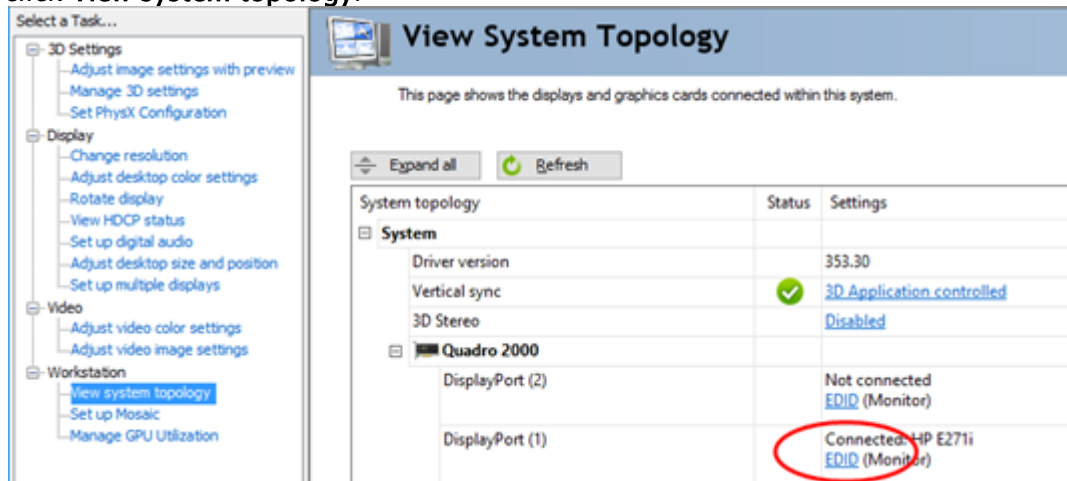

2. Click the **EDID** link on one monitor, and select the **Load** tab.
3. Click the **Browse** button and select the EDID file to be loaded. This file is usually included on the CD or DVD containing drivers, utilities and documentation for the display. If not, please contact the display manufacturer to obtain the required file.

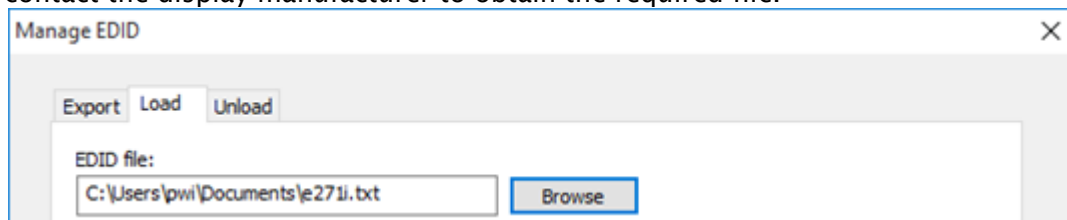

4. In the **Select Connector to force EDID** panel, check all connected displays, then click **Load EDID**.
5. When the EDID file has been applied to all displays, check the properties of every display in the **View System Topology** section. They must all run on 59.94 Hz.
6. Proceed [To Create a Custom 59.94 Hz Resolution](#).

To Create a Custom 59.94 Hz Resolution

1. Enter the **Change resolution** section of the NVIDIA control panel.

2. In the first section, **Select the display you would like to change**, select display number 1 and click the **Customize...** button:

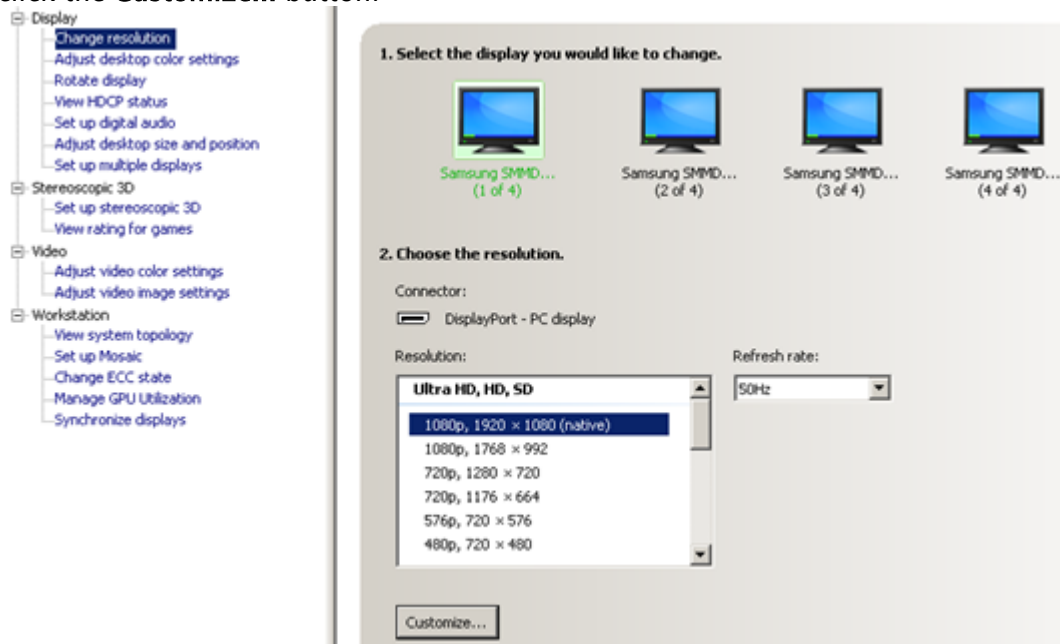

3. In the upcoming dialog, tick the **Enable resolutions not exposed by the display** check box, and click **Create Custom Resolution...**

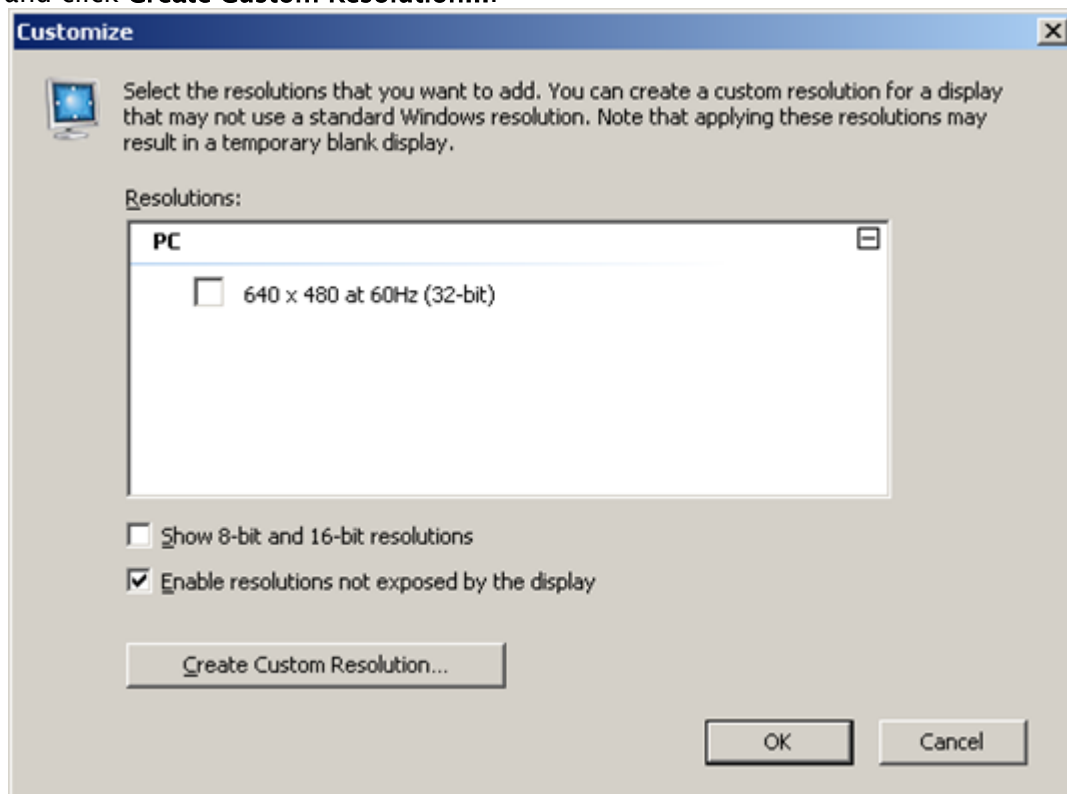

4. Select all displays in the upcoming dialog:

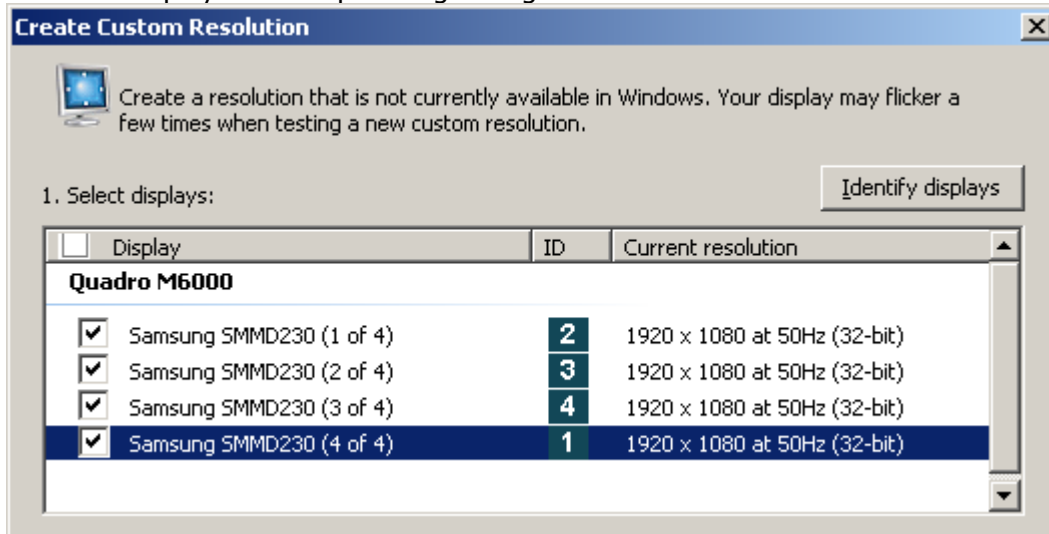

5. Enter a **Refresh rate (Hz)** of 60 Hz and leave all other settings to their default values:

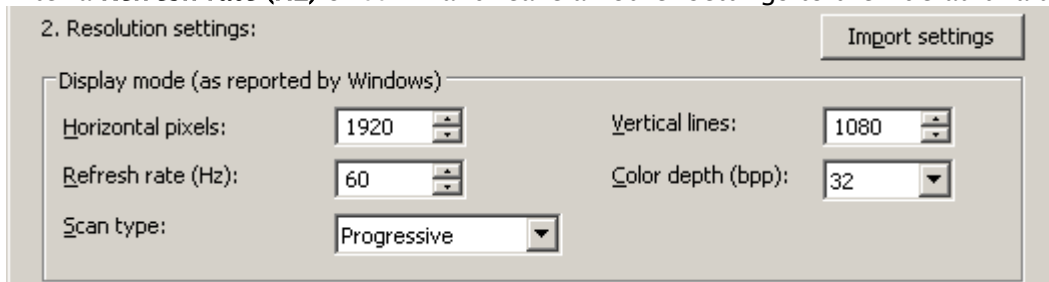

In the Timing panel, select **Manual** timing adjustment from the **Standard** drop-down list. Set the **Refresh rate** to 59.940 Hz, and leave all other settings to their respective default values:

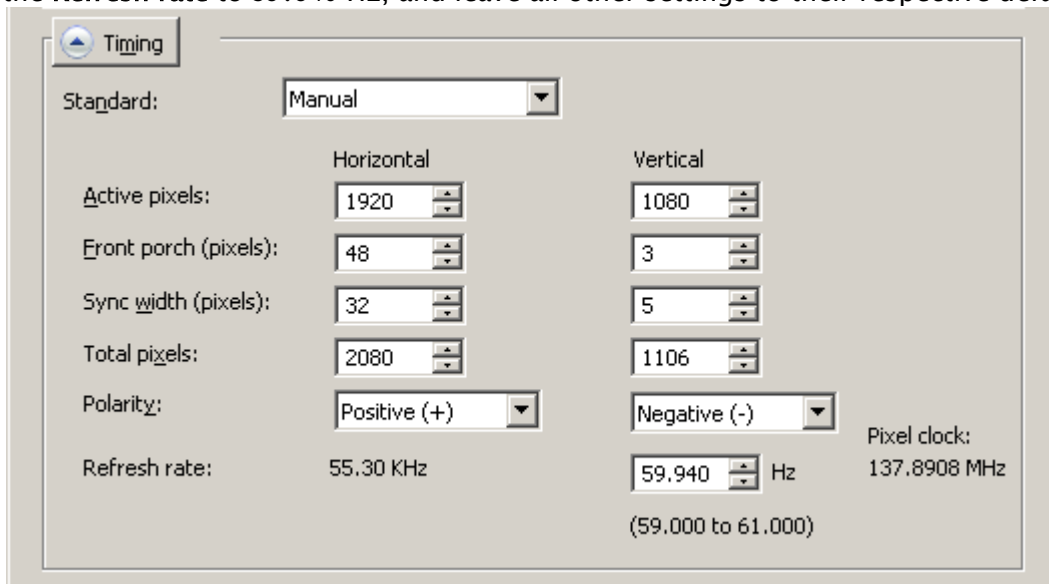

6. Click the **Test** button. The connected monitors might go black for several seconds while adjusting to the new refresh rate. Do not press any key on the keyboard or buttons on the mouse while this goes on. When the screens returns to normal, acknowledge the new settings by pressing **Yes** in the upcoming dialog.

7. The newly created resolution now shows up as illustrated below and has been applied to all displays.

IMPORTANT! Please note that for 59.94 Hz setups, the server refresh rate might report to be 60 Hz when the external house sync is 59.94 Hz. Even though the custom resolution states to be 60 Hz, the correct value under the hood is 59.94 Hz.

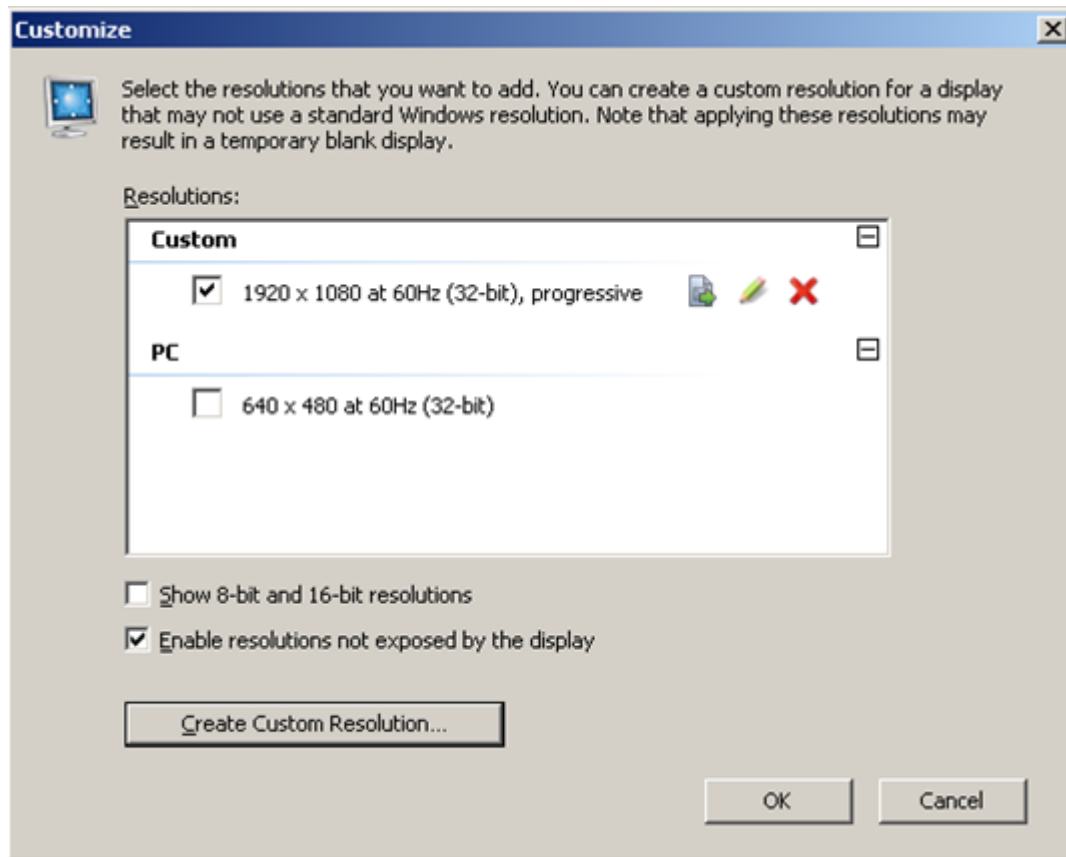

To Change from 59.94 Hz to 50 Hz Refresh Rate

If changing the frequency from 59.94 Hz back to 50 Hz, the EDID file must be unloaded for all connected displays, followed by rebooting the machine. Otherwise, Mosaic can not be applied.

1. In the **NVIDIA Control Panel**, expand the **Workstation** section of the **Select a Task...** menu and click **View system topology**:

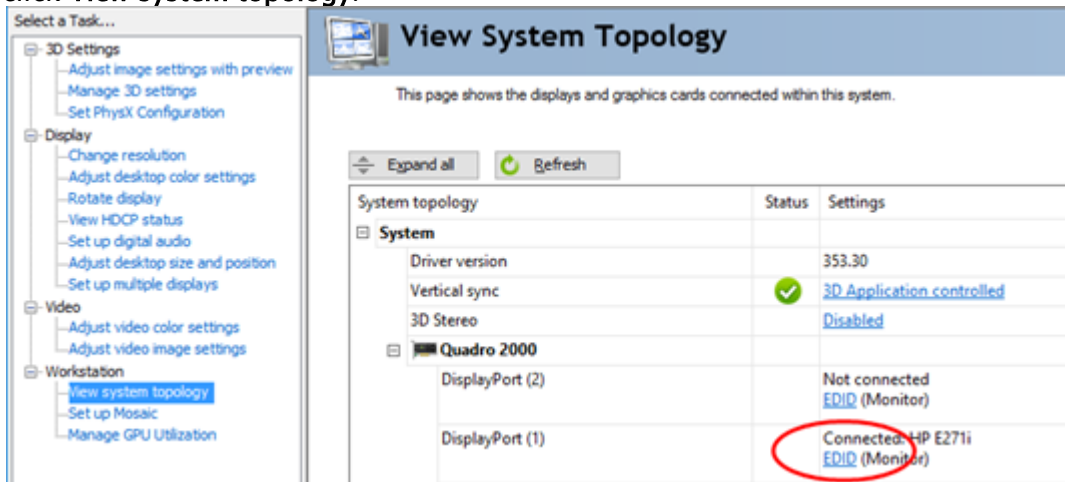

2. Click the **EDID** link on one monitor, and select the **Unload** tab.
3. Select all connected displays and click the **Unload** button.
4. Repeat the step above for all monitors one at a time.
5. Restart the computer and proceed with the [NVIDIA Mosaic Configuration for 1080i50](#).

12.3.7 NVIDIA Mosaic Configuration for 1080i50

The procedure described below assumes that the [NVIDIA Driver Configuration](#) has been completed during initial setup of the computer running Viz Engine. If not, refer to the [Graphics Boards](#) chapter for details on setting up the NVIDIA hardware correctly for use with Viz Engine.

1. Enter NVIDIA Control Panel.
2. Disable synchronization of displays, by selecting **On another system**.

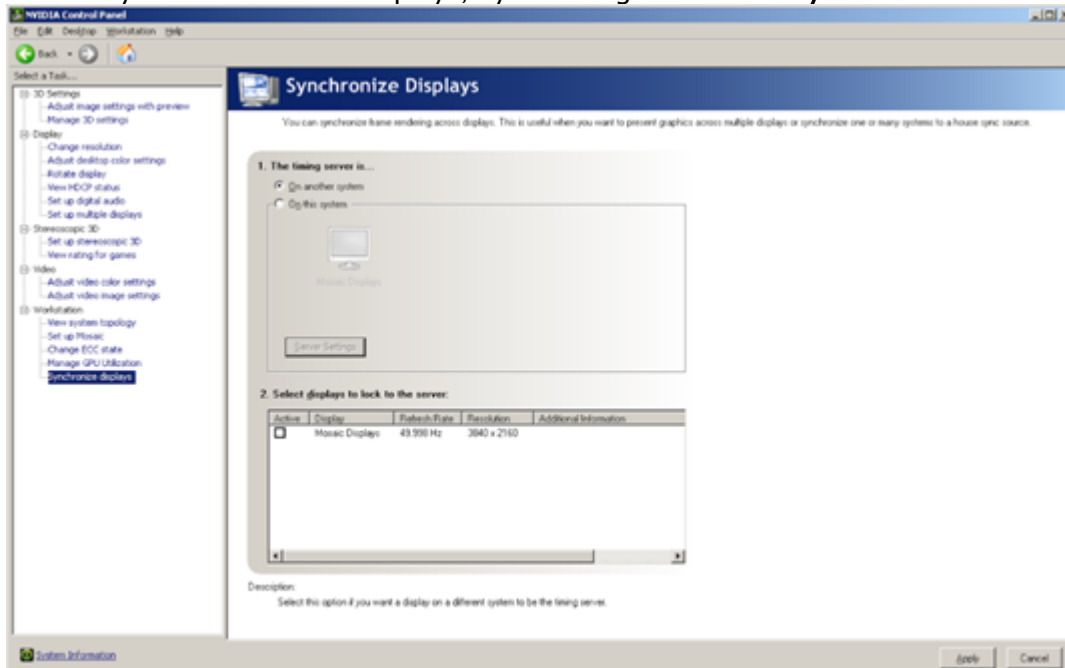

3. Establish a 50Hz Mosaic setup by selecting **Set up Mosaic** from the **Workstation** panel:

- In step 1. **Select topology**, make sure to leave the **I am using recommended connections for the selected topology** check box unchecked.
- In step 2. **Select displays**, select all displays that are to be used for the video wall, for example 1, 2, 3 and 4, and select **50 Hz** as frequency rate.
- In step 3. **Arrange displays**, drag and drop the displays according to the physical arrangement, not by the **On Screen Display** numbering. This can result in the monitors being arranged as 1, 4, 3, and 2, ensuring proper layout.

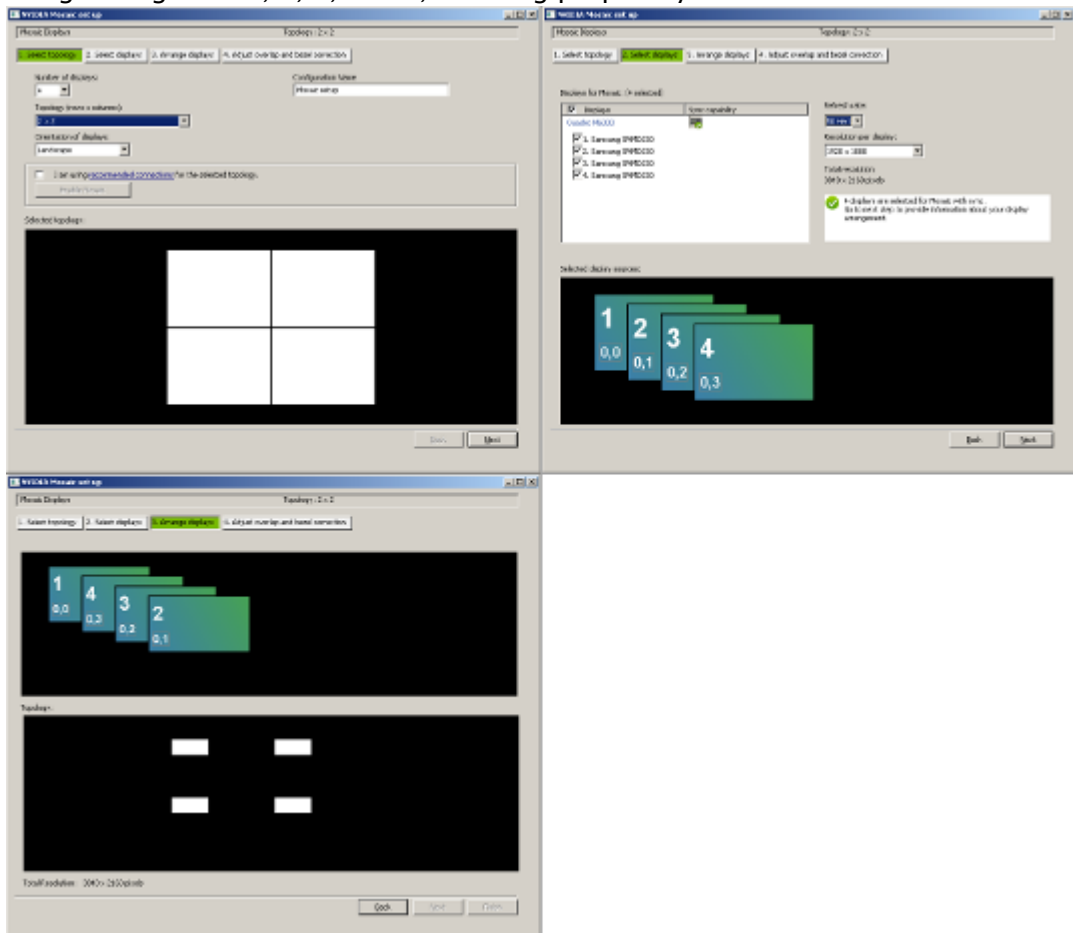

4. Enter section **Synchronize Displays** in the NVIDIA Control Panel and choose **On this system** for the question regarding the timing server, then click the **Server Settings** button.

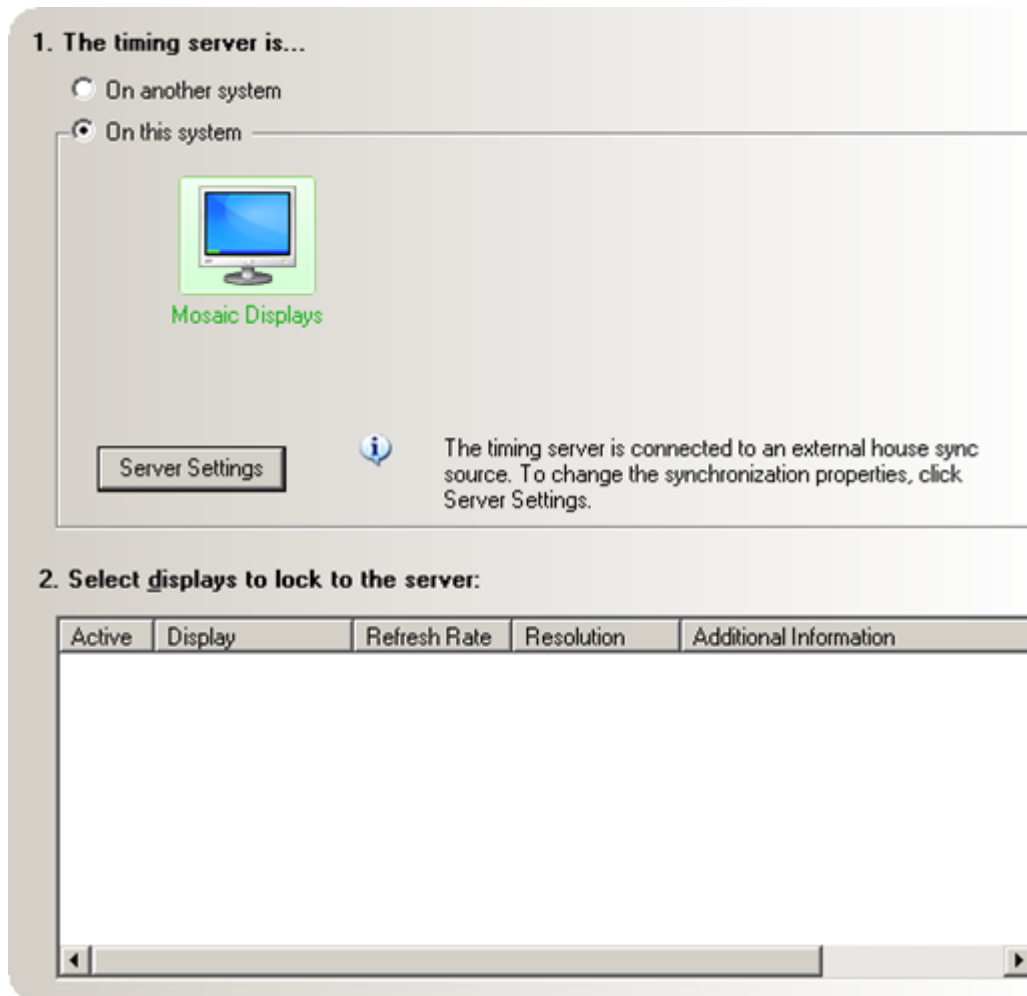

Make sure the presented server refresh rate matches the one of the incoming Genlock signal. Choose **An external house sync signal**. Leave all other settings as they are, and apply

the changes.

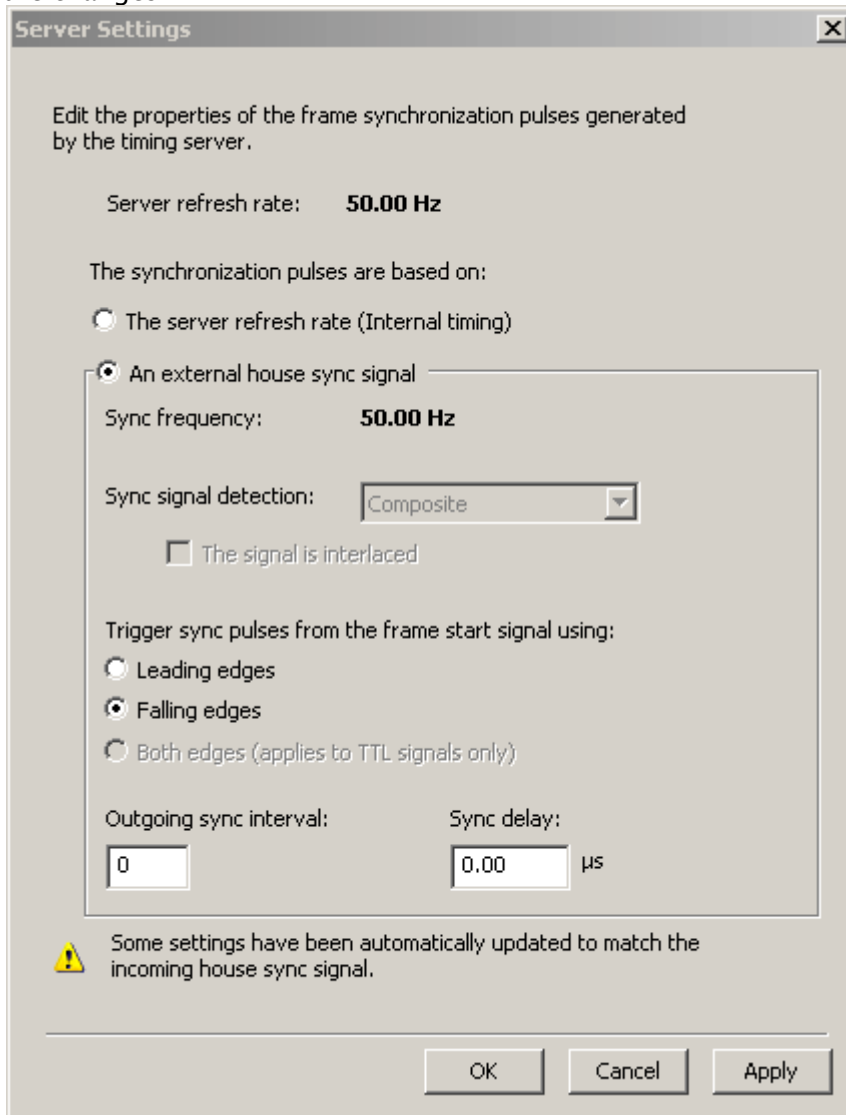

5. Check the **Topology** in the NVIDIA Control Panel:

Mosaic Displays

System topology	Status	Settings
Mosaic Displays		
Configuration		2 x 2 Topology
Resolution, refresh rate		3840 × 2160 pixels, 50.00 Hz
Display Sync State		Quadro Sync Server
Timing		The display is locked to the house sync signal
OS Screen Identifier		2

The **View System Topology** panel reports that **The display is locked to the house sync signal** for one of the connected displays. For the other connected displays, the report states that **The display is locked to the frame lock sync pulse**.

Displays and Graphics Cards

System topology	Status	Settings
System		
Driver version		353.30
Vertical sync		3D Application controlled
3D Stereo		Disabled
Quadro Sync (server)		
Framelock 0		Out
Framelock 1		Out
External sync signal		Present (In use)
Framelock sync pulse		Present
Sync settings		Synchronize Displays
Samsung SMMD230 (1 of 4)		Mosaic Display (2 x 2 topology)
Display state		Server
Resolution, refresh rate , color depth		3840 x 2160 pixels, 49.998 Hz, 32 bpp
Timing		The display is locked to the house sync signal
Samsung SMMD230 (2 of 4)		Mosaic Display (2 x 2 topology)
Display state		Client
Resolution, refresh rate , color depth		3840 x 2160 pixels, 49.998 Hz, 32 bpp
Timing		The display is locked to the frame lock sync pulse

6. Check the LEDs on the [NVIDIA Quadro Sync](#).

7. Configure Bezel/Overlap for Mosaic in the NVIDIA Control Panel:

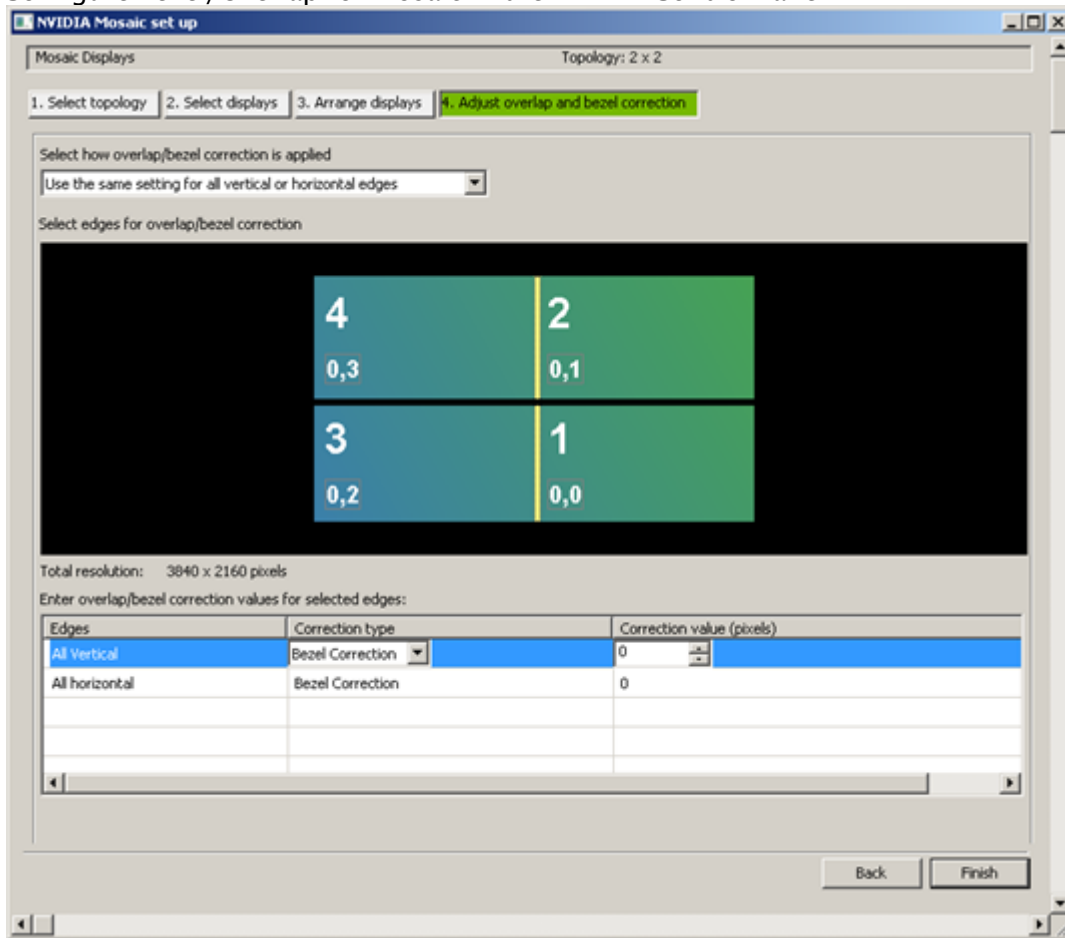

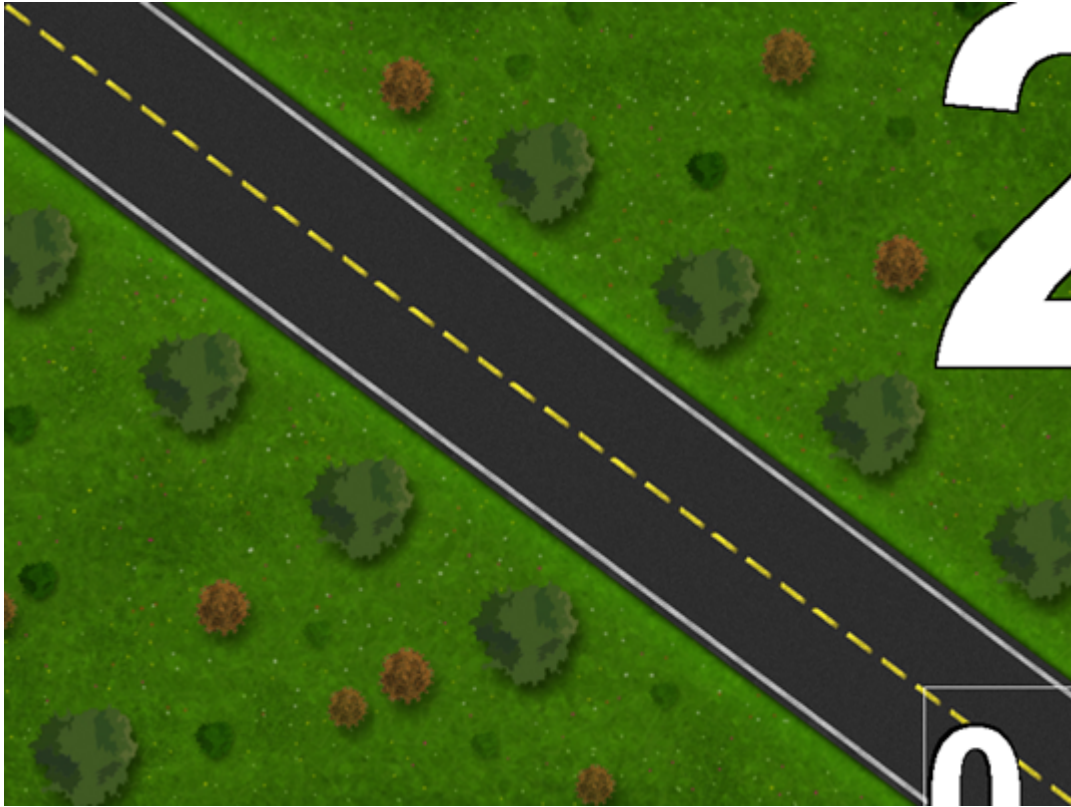

12.3.8 NVIDIA Mosaic Configuration for 1080i60M

In case the video-wall displays in use natively supports a refresh rate of 59.94 Hz, the setup procedure described in [NVIDIA Mosaic Configuration for 1080i50](#) can be followed, only selecting a refresh-rate of 59.94 Hz while creating the Mosaic:

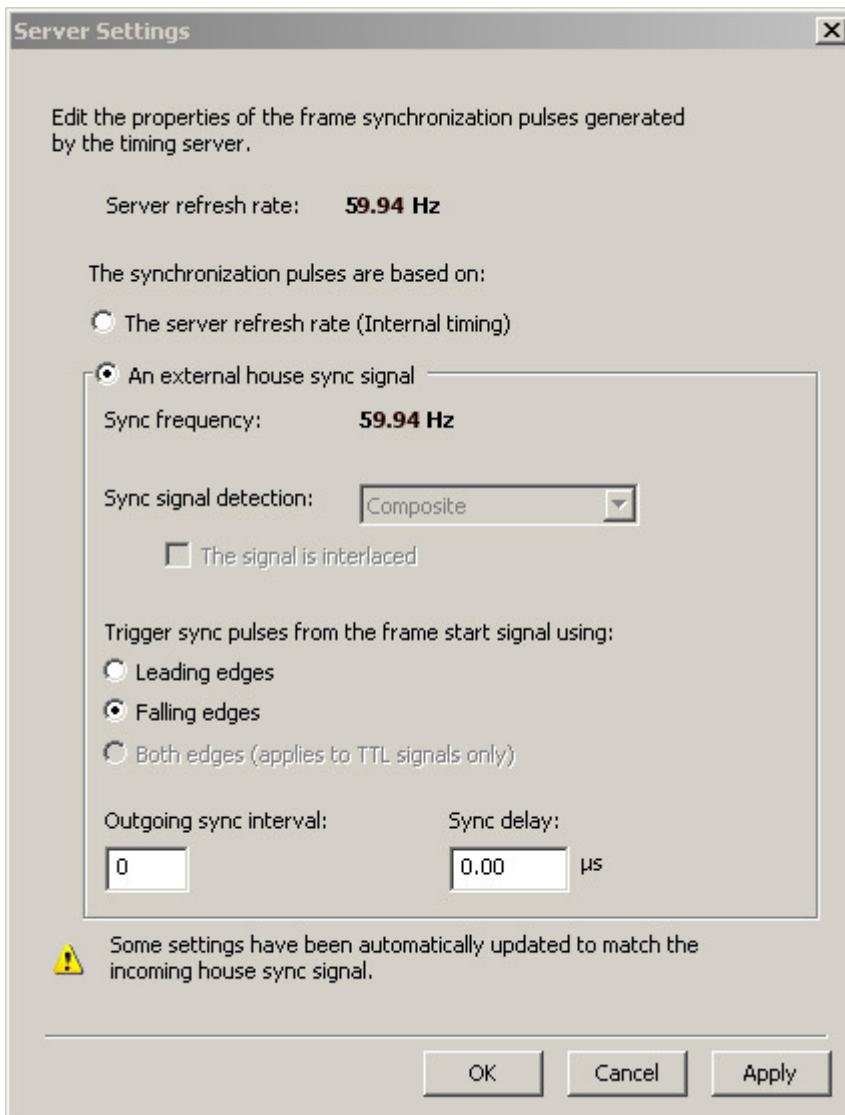

If this is not the case, a number of steps need to be performed in advance, as described in the section [To Create a Custom 59.94 Hz Resolution](#). An **EDID-file** is *always* required to run monitors that do not natively support 59.94 Hz frequency at that frequency. Contact the display hardware vendor to obtain the correct EDID file for the monitors in use.

1. To configure Mosaic for 1080i60M, follow the steps described in the [NVIDIA Mosaic Configuration for 1080i50](#) section. Make sure to select a refresh-rate of 59.94 Hz during step 2 of the Mosaic creation process. Depending on the NVIDIA driver installer, sometimes 59.94 Hz is not available from the **Refresh rate** drop-down list, even if the loaded EDID-file

enables this frequency rate. If this is the case, select 60 Hz:

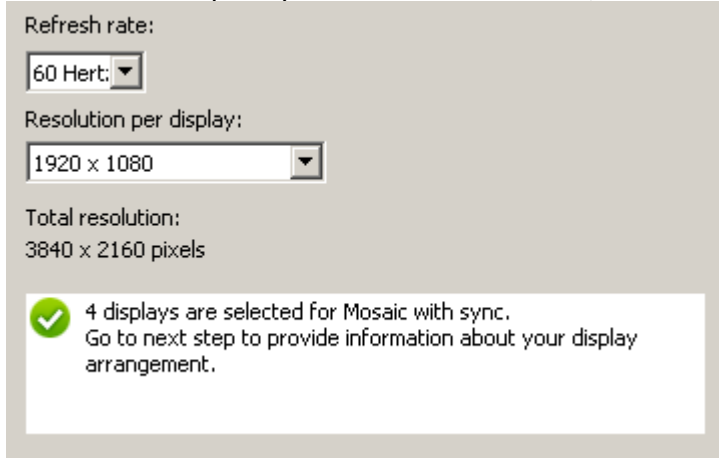

2. Once Mosaic is configured and the G-Sync device has been locked to the house-sync, the topology in the NVIDIA control panel should look as follows, with the report for one of the connected displays stating **The display is locked to the house sync signal**.

Mosaic Displays

System topology	Status	Settings
Mosaic Displays Configuration Resolution, refresh rate Display Sync State Timing OS Screen Identifier		2 x 2 Topology 3840 x 2160 pixels, 59.94 Hz Quadro Sync Server The display is locked to the house sync signal 2

Displays and Graphics Cards

System topology	Status	Settings
System Driver version Vertical sync 3D Stereo		353.30 3D Application controlled Disabled
Quadro Sync (server) Framelock 0 Framelock 1 External sync signal Framelock sync pulse Sync settings		Out Out Present (In use) Present Synchronize Displays
Samsung SMMD230 (2 of 4)		Mosaic Display (2 x 2 topology)
Display state Resolution, refresh rate, color depth Timing		Server 3840 x 2160 pixels, 59.939 Hz, 32 bpp The display is locked to the house sync signal

The report for all other displays should be that **The display is locked to the frame lock sync**

pulse.

  Samsung SMMD230 (3 of 4)	Mosaic Display (2 x 2 topology)
Display state	Client
 Resolution, refresh rate , color depth	3840 x 2160 pixels, 59.939 Hz, 32 bpp
Timing	 The display is locked to the frame lock sync pulse

3. Check the LEDs of the [NVIDIA Quadro Sync](#).

4. Configure Bezel/Overlap for Mosaic in NVIDIA control panel:

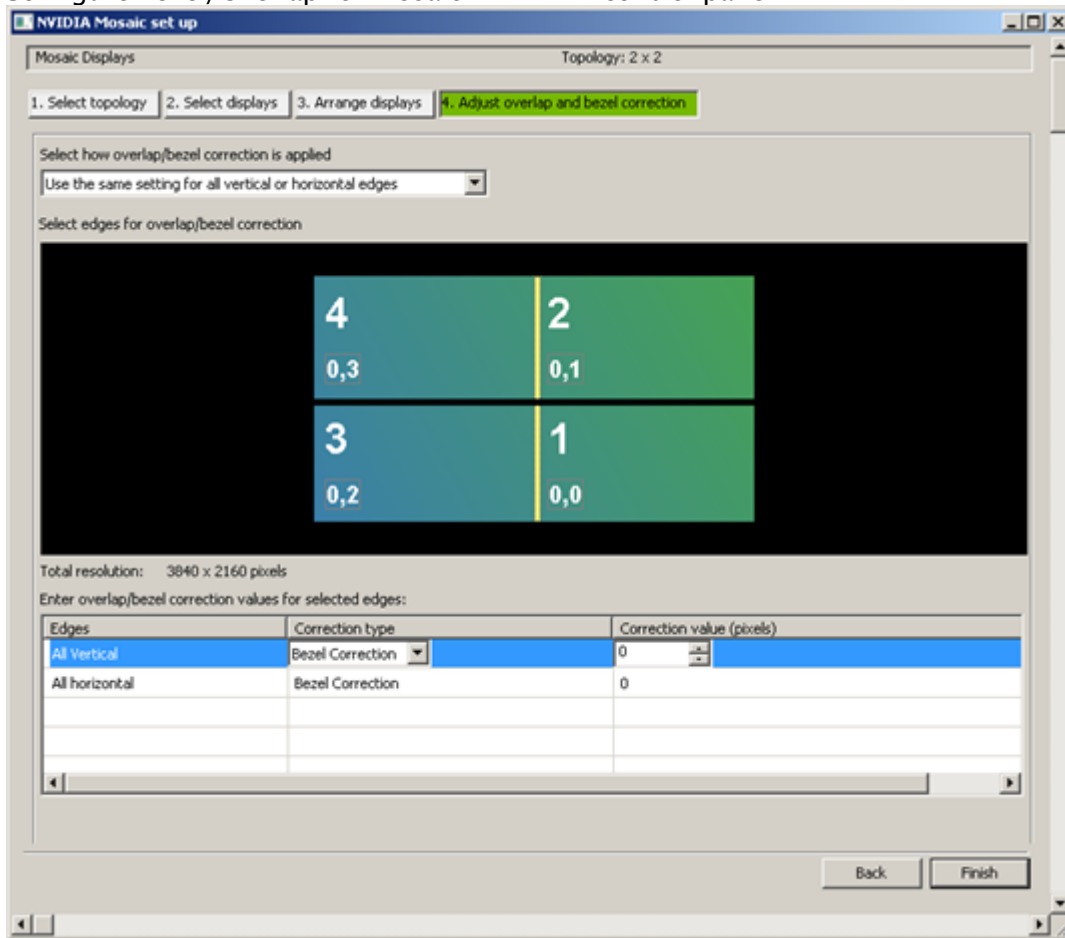

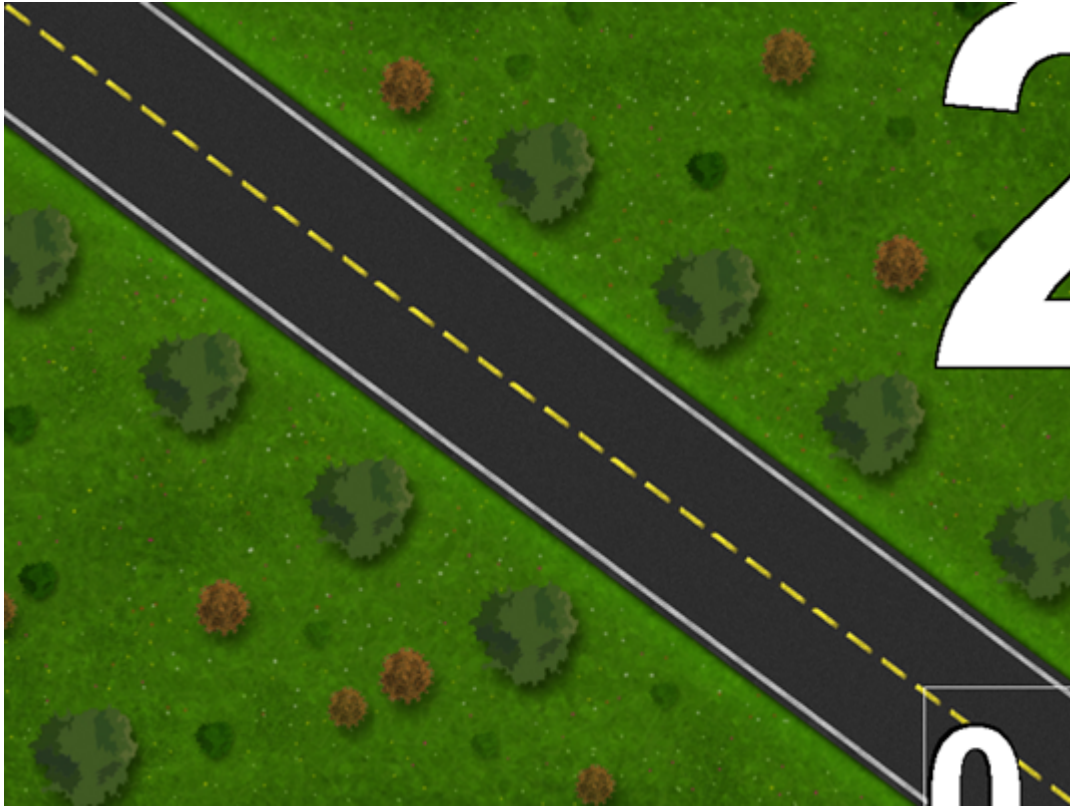

5. Proceed with configuring the required [Viz Engine Video Wall Configuration Settings](#).

12.3.9 Viz Engine Video Wall Configuration Settings

To Configure Viz Engine for Video Wall

1. Open Viz Configuration, and create a backup of the existing configuration settings by saving them to a new file.
2. Import a configuration profile for the desired input format from the selection of [Installed Configuration Profiles](#). These ship with the Engine installation, and are located in the `<viz install folder>\Configuration Profiles` folder. The input format files are named `video-resolution-*.cfg`, where the asterisk represents the frame rate the configuration is suitable for, if it includes audio settings, and which video hardware it is designed for. For example, the audio enabled configuration file for the Matrox X.mio3 video board running in 1080i50 resolution, is called `video-resolution-1080i50-audio-xmio3.cfg`.
3. Next, import a Video wall configuration profile, where the frame rate matches the one loaded for the video hardware in the previous step. As with the input format profiles, these are located in the `<viz install folder>\Configuration Profiles` folder. These configuration files are named `videowall-*.cfg`, where the asterisk represent the frame rate the selected

configuration file is suitable for:

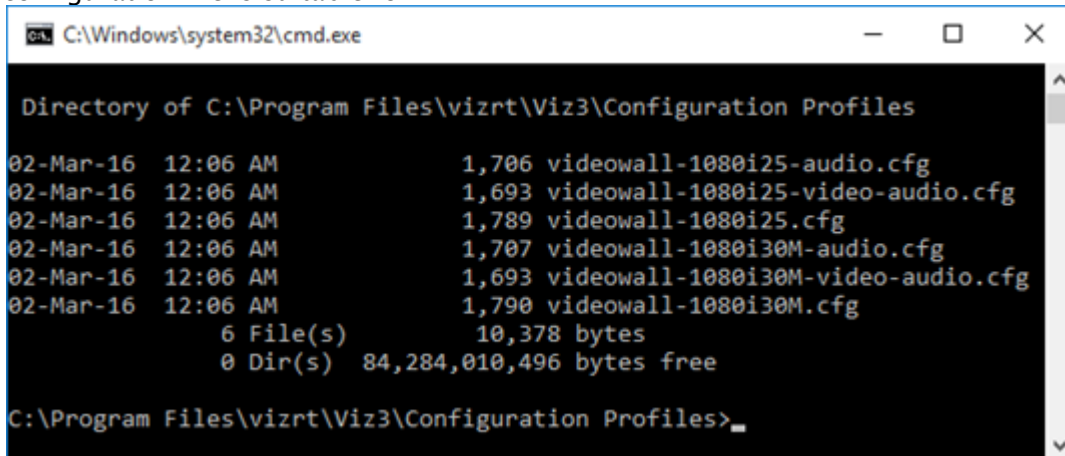

4. Adjust the **Output Format** in Viz Config:

- Verify that **Fullscreen** is the selected format in the output format specification list. The output format **MUST** be "Fullscreen" and not "User Defined". Only **Fullscreen** and **Videowall mode on** forces the engine to go into Videowall Mode.
- The frame rate should have been set when loading the *videowall-*.cfg* configuration profile in step two. Ensure that the correct values are set for the required output. For PAL systems, set the **Frame** value to 50. For NTSC systems, set the **Frame** value to 59.94.
- Set the **Aspect** value to the aspect ratio of the video wall. The aspect ratio decimal value is found by dividing the number of pixels, width by height. This value depends on the actual video wall display layout and needs to be adjusted if changes to the display layout are made.

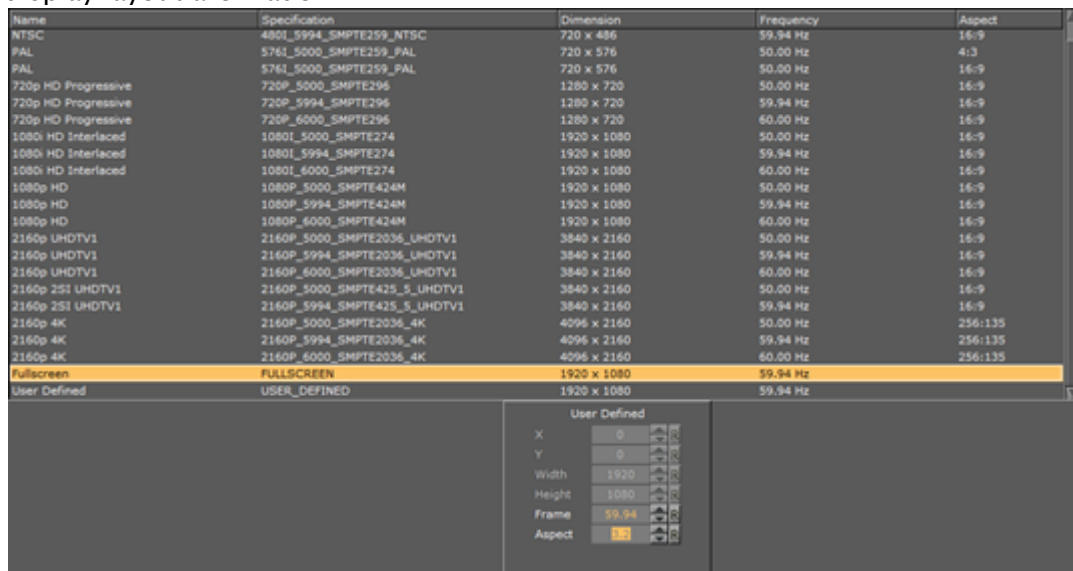

5. Verify the following **Video Output** settings:

- **Video wall/Multi-display** should be set to Active.
- Click the **Show Video Output Config. Editor** button and verify that the required Genlock is set. For configurations with the Matrox X.Mio3 video board, Genlock must be set to **Auto**. Other configurations can be set to **Auto**, **Blackburst** or **Tri-Level**, as

required:

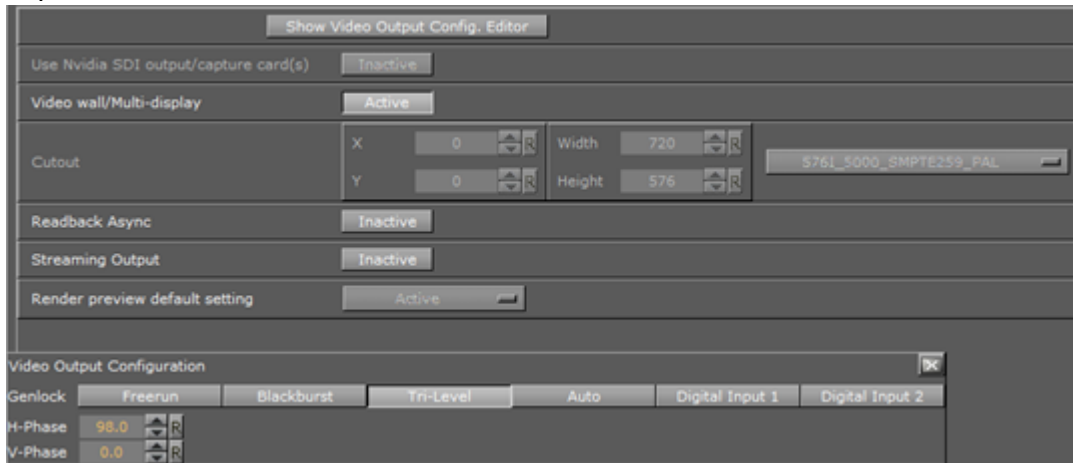

6. Under **Render Options**, disable **On Air Mouse Cursor**.
7. In the **Video Input** section, enable the required number of **Live** and **Clip Channel** sources. Unused live inputs should be deactivated, as activating them could have an impact on performance.

Live 1		Live 2		Live 3		Live 4	
SD i	SD i	SD i	SD i	SD i	SD i	SD i	SD i
HD 720p	HD 720p	HD 720p	HD 720p	HD 720p	HD 720p	HD 720p	HD 720p
HD 1080i	HD 1080i	HD 1080i	HD 1080i	HD 1080i	HD 1080i	HD 1080i	HD 1080i
HD 1080p	HD 1080p	HD 1080p	HD 1080p	HD 1080p	HD 1080p	HD 1080p	HD 1080p
inactive	inactive	inactive	inactive	inactive	inactive	inactive	inactive
Clip Channel 1		Clip Channel 2		Clip Channel 3		Clip Channel 4	
SD i	SD i	SD i	SD i	SD i	SD i	SD i	SD i
HD 720p	HD 720p	HD 720p	HD 720p	HD 720p	HD 720p	HD 720p	HD 720p
HD 1080i	HD 1080i	HD 1080i	HD 1080i	HD 1080i	HD 1080i	HD 1080i	HD 1080i
HD 1080p	HD 1080p	HD 1080p	HD 1080p	HD 1080p	HD 1080p	HD 1080p	HD 1080p
UHD 2160p	UHD 2160p	UHD 2160p	UHD 2160p	UHD 2160p	UHD 2160p	UHD 2160p	UHD 2160p
UHD 2160p 2si	UHD 2160p 2si	UHD 2160p 2si	UHD 2160p 2si	UHD 2160p 2si	UHD 2160p 2si	UHD 2160p 2si	UHD 2160p 2si
4K 2160p	4K 2160p	4K 2160p	4K 2160p	4K 2160p	4K 2160p	4K 2160p	4K 2160p
inactive	inactive	inactive	inactive	inactive	inactive	inactive	inactive
Stream 1		Stream 2		Stream 3		Stream 4	
SD i	SD i	SD i	SD i	SD i	SD i	SD i	SD i
HD 720p	HD 720p	HD 720p	HD 720p	HD 720p	HD 720p	HD 720p	HD 720p
HD 1080i	HD 1080i	HD 1080i	HD 1080i	HD 1080i	HD 1080i	HD 1080i	HD 1080i
HD 1080p	HD 1080p	HD 1080p	HD 1080p	HD 1080p	HD 1080p	HD 1080p	HD 1080p
inactive	inactive	inactive	inactive	inactive	inactive	inactive	inactive

8. Disable GPU-Direct in the **Video Board** section of Viz Configuration.
9. Manually edit the configuration file, and set the flag `use_threaded_io` to 1.
10. In the **Database** section, specify which Viz Graphic Hub to use and provide the login credentials.

11. Start Viz Engine without a User Interface, by executing the following command from the command line: `<viz install folder>\viz.exe -n -w .`

⚠ IMPORTANT! On Windows 10, it might happen that Viz renders at half the speed (25fps) and renders full speed if the focus is on another window. In this case, change the startup parameter to `<viz install folder>\viz.exe -n -y.`

12. Load a scene containing a single live-video or clip source as a texture and scale it up to full screen. If running Viz Artist, switch to [On Air Mode](#). Watch for drops in the video wall output within the first 60 seconds.
13. Verify the configuration of the NVIDIA driver by checking the Topology Inspector, and check the Viz Engine configuration. This is especially important when setting up a 59.94 Hz video-wall, as a wrong refresh-rate of 60 Hz could get applied to the displays by mistake.
14. In general, a proper Mosaic setup is automatically synchronized with Viz Engine. However, it can be necessary to force Viz Engine to synchronize. This is necessary for all setups with multiple graphics cards.

To force synchronization, issue the following command in the Engine Console: `send RENDERER JOIN_SWAPGROUP 1.`

⚠ IMPORTANT! Do not execute this command unless needed, as this may have an impact on performance.

If the computer is rebooted or Viz Engine restarted, the command needs to be sent again. To avoid doing this manually every time the Engine starts, set the `swapgroup` value in the **RENDER_OPTIONS** section of the configuration file to 1. The default value is 0.

✓ Tip: This synchronization can also remedy certain tearing effects. Create a simple scene with a bar running left to right. If any of the connected monitors display tearing effects, try sending the above command.

Audio Output

For performance reasons, in a Video Wall setup the video out channels are usually set to **Unused**. To configure a Video Wall with embedded or AES audio output, the video out channel must be mapped to the selected Matrox channel. Set **Map to Viz Channel** in the [Matrox VideoOut Properties](#) in Viz Configuration.

⚠ Note: When running a Video Wall with audio out, even though the video out channel is mapped, the SDI output is black.

It is highly recommended to not use the audio output of the installed video board. Audio can usually also be grabbed from one of the HDMI/Display Port connectors of the Nvidia board.

Newtek NDI

Please note, that NDI input is currently not supported on videowall setups.

12.4 Troubleshooting Video Wall Configurations

Please take a look at this section prior to configuring a Video Wall for the first time. It provides solutions for common issues which may arise during setup, and covers the following topics:

- [Performance Issues](#)
- [Steps to Recover from Severe NVIDIA Mosaic Driver Related Issues](#)
- [Experiencing BSOD or System Freeze while Setting up Mosaic](#)
- [Only Some Displays of the Video Wall display an Image](#)
- [Missing NVIDIA Control Panel Settings](#)
- [NVIDIA Control Panel Crashes](#)
- [Mosaic Configuration Not Supported Error](#)
- [G-Sync Status LEDs or Topology Reports Indicate a Synchronization Issue](#)
- [Poor Performance when Using GFX Channels as DVE](#)
- [Jittering on HP Z840](#)
- [Artist output appears scaled](#)
- [Other Synchronization Issues](#)

 **Note:** Run Viz Engine in Engine mode and not in Artist mode. The startup should be `viz.exe -n -w`. The Engine is correctly configured only if Viz starts with a full black window with `-w` parameter.

12.4.1 Performance Issues

Create a simple scene with a bar moving from left to right and back in an endless loop, and run this scene on the newly configured Video Wall to spot issues such as jittering, tearing effects, etc. When troubleshooting performance issues, always make sure to check the following before investigating further:

- Make sure that the system meets the [Minimum Hardware Configuration for Video Walls](#).
- Make sure that the [Pre-Requirements for all Setups](#) are met.
- Check that graphics and video devices are on the same CPU bus. The GPUs should always have priority.
- Make sure that the power connector to the graphics device is connected properly. The power connector must be 8-pin or use the 6-to-8-pin adapter included with the graphics device.
- Check that the [HP Z8 G4](#) or **BIOS Settings** are correctly configured.
- Check the [Viz Engine Video Wall Configuration Settings](#).
- [Configure the NVIDIA driver for Video Wall](#).

If performance problems persist, a possible solution may be to increase the **Reactivation Delay** value in Viz Configuration. Please refer to the setting [Video Input: Clip Input](#).

12.4.2 Steps to Recover from Severe NVIDIA Mosaic Driver Related Issues

1. Remove the NVIDIA drivers.
2. Shutdown the system.
3. Ensure that all monitor cables are connected properly to the graphics card.
4. Boot the system.
5. Reinstall the NVIDIA drivers.

12.4.3 Experiencing BSOD or System Freeze while Setting up Mosaic

While operating in Mosaic mode, any changes to the physical setup, such as adding or removing monitors, can cause a system crash resulting in a Blue Screen of Death or complete system freeze. There is a chance to run into follow-up issues (mentioned in this chapter) after the system has rebooted.

12.4.4 Only Some Displays of the Video Wall display an Image

There can be multiple reasons for this. Please ensure that:

- All monitors are connected properly to the graphics device and that they are active.
- Delete and re-create your Mosaic setup in the NVIDIA Control Panel.
- Please refer to section [Steps to recover from severe NVIDIA Mosaic driver related issues](#) in case the issue persists.

12.4.5 Missing NVIDIA Control Panel Settings

Please perform a re-installation of the NVIDIA driver as mentioned in section [Steps to recover from severe NVIDIA Mosaic driver related issues](#). A known cause for this behavior are physical changes to an existing video-wall setup, for instance adding or removing monitors, while operating in Mosaic mode.

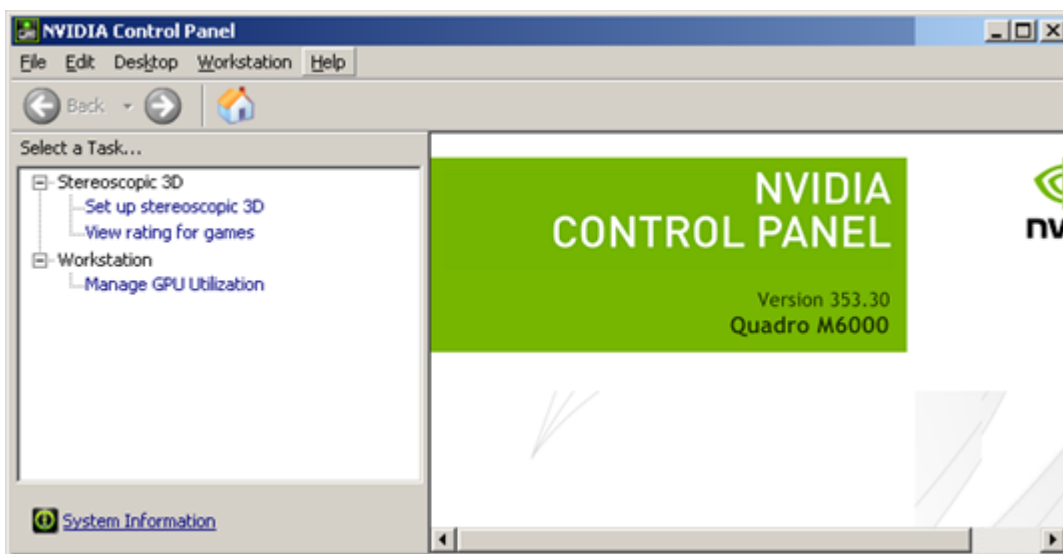

12.4.6 NVIDIA Control Panel Crashes

There is a possibility that the NVIDIA Control Panel crashes during Mosaic configuration, although this is not considered a reliable indicator on whether a driver re-installation is required or not. Sometimes the NVIDIA Control Panel can be restarted manually, and usually rebooting the machine should suffice.





Please refer to section [Steps to recover from severe NVIDIA Mosaic driver related issues](#) if the issue persists.

12.4.7 Mosaic Configuration Not Supported Error

If running with two or more cards, make sure the same outputs are used on each card. For example, if using two DisplayPort outputs and one DVI output on the first card, the same outputs must be used on the second card, etc. Failure to do so may result in Mosaic setup failure, with an error message stating that the configuration is not supported.

12.4.8 G-Sync Status LEDs or Topology Reports Indicate a Synchronization Issue

If the status LEDs on the NVIDIA G-Sync status LEDs indicate an issue, or the topology reports "The display is locked to the house sync signal" for all displays, the topology view may indicate that everything is fine at first sight. However, when taking a closer look at the topology, it reveals that all monitors seem to sync to the **house sync signal** instead of reporting that the display is locked to the **frame lock sync** pulse:

  Samsung SMMD230 (1 of 4)	Mosaic Display (2 x 2 topology)
Display state	Server
 Resolution, refresh rate , color depth	3840 × 2160 pixels, 49.998 Hz, 32 bpp
Timing	 The display is locked to the house sync signal

This indicates that there exists a synchronization issue which needs to be fixed. Solving this may require going through one or several of the following steps:

1. **Re-establish synchronization**
 - a. Disable display synchronization in section **Synchronize Displays**.
 - b. Re-establish synchronization.
See the [NVIDIA Mosaic Configuration for 1080i50](#) or [NVIDIA Mosaic Configuration for 1080i60M](#) sections for more detailed instructions.
2. **Reconnect G-SYNC signal cables**
 - a. Physically disconnect the sync cable from the G-SYNC card.
 - b. Reconnect the sync cable.
 - c. Switch synchronization back on in the NVIDIA Control Panel. Go to **Synchronize Displays** and set the radio button to **An external house sync signal**. See the [NVIDIA Mosaic Configuration for 1080i50](#) or [NVIDIA Mosaic Configuration for 1080i60M](#) sections for more detailed instructions.
 - d. Verify the LEDs on the [NVIDIA Quadro Sync](#), or in the Topology Inspector of the NVIDIA Control Panel.
 - e. If this does not help, try to reboot the machine.

In case this does not fix the issue:

1. Disable display synchronization in section Synchronize Displays.
2. Shutdown the machine.
3. Check cabling and signal sources.
4. Reboot the machine.
5. Re-establish synchronization as mentioned in section Synchronize Displays.

12.4.9 Poor Performance when Using GFX Channels as DVE

On high resolution Video Walls in particular, poor performance may be experienced when using GFX channels as DVEs. This is caused by anti-aliased "blitting". To disable anti-aliasing on GFX channels, open the Viz configuration file, locate the `gfx_channels_antialiased` string, and set the value to 0. The default value is 1.

Example: `gfx_channels_antialiased = 1`

Note: Turning on **GPUDirect** can result in less performance than running without it. There is a workaround for this problem and we recommend to use this setting in video wall setups. Enable the flag **use_threaded_IO** in the configuration file. **Setting:** `use_threaded_IO = 1`

12.4.10 Jittering on HP Z840

Jittering on the HP Z840 is most commonly caused by a missing swapgroup. Make sure to run the `RENDERER_JOIN_SWAPGROUP 1` command to the Engine.

12.4.11 Artist output appears scaled

Although running Artist on a Videowall configuration is not supported, it might happen that the output is only half or quarter of the original size. This is due a scaling factor of windows that might have been set to improve readability on videowall displays. Viz Engine does not support these scaling technology, therefore it must be turned off.

12.4.12 Other Synchronization Issues

When attaching the connector cables between the graphics card and the G-SYNC card, make sure that the red line on all of the connector cables are facing the card's mounting bracket, towards the back of the case. Failure to do so can result in synchronization issues. In rare cases, syncing with only the NVIDIA G-SYNC can result in more stable synchronization. If all else fails, try disconnecting the reference signal from the Matrox board.

13 SNMP Support

13.1 Introduction

SNMP (Simple Network Management Protocol) is a standard, usually UDP based protocol used for collecting information about managed services over IP networks. The device can send notifications (traps) on important state changes.

All values are addressed using a dotted notation string which is represented by a tree structure. Vizrt's registered subtree is 1.3.6.1.4.1.27566. followed by an unique identifier for differend products like Viz Engine (1) or Viz Graphic Hub (2). The subtree for instance one of a Viz Engine would be 1.3.6.1.4.1.27566.1.1. It then splits up into a data part (1) and SNMP compliance mandatory structures (2).

The SNMP Extension is a DLL, an extension for the built-in Windows SNMP service. The agent (one per DLL) provides data to the service which can be retrieved by the SNMP protocol. The agent can also trigger sending SNMP traps (notifications).The service runs as LocalSystem user. The current SNMP version supported is 2c. Version 2c is the most common standard. Version 1 is obsolete, version 3 is not yet, if ever, supported by Microsoft.

13.2 Installation

13.2.1 Prerequisites

Before installing the SNMP Extension, the Windows SNMP service has to be installed and configured. This is usually a part of the workstation or server operating system. It has been tested using Windows 7 and Windows 10.

13.2.2 To install the services

- Open the **Control Panel**.
- Select **Programs and Features** , then **Turn Windows Features On or OFF** list in **Control Panel > Programs and Features**.
- Select the **Simple Network Management Protocol (SNMP)**, the subfeature *WMI SNMP Provider* is not being used.

You'll find it afterwards in **Computer Management > Services**.

- On Tab **Security**
 - Click **Add** to **Accepted community names**.
 - Enter `public` to the **Community** name.
 - Set the Community right to **READ ONLY**.
- On tab **Traps** enter:
 - Community name: `public`.
 - Possible trap destinations `127.0.0.1`.

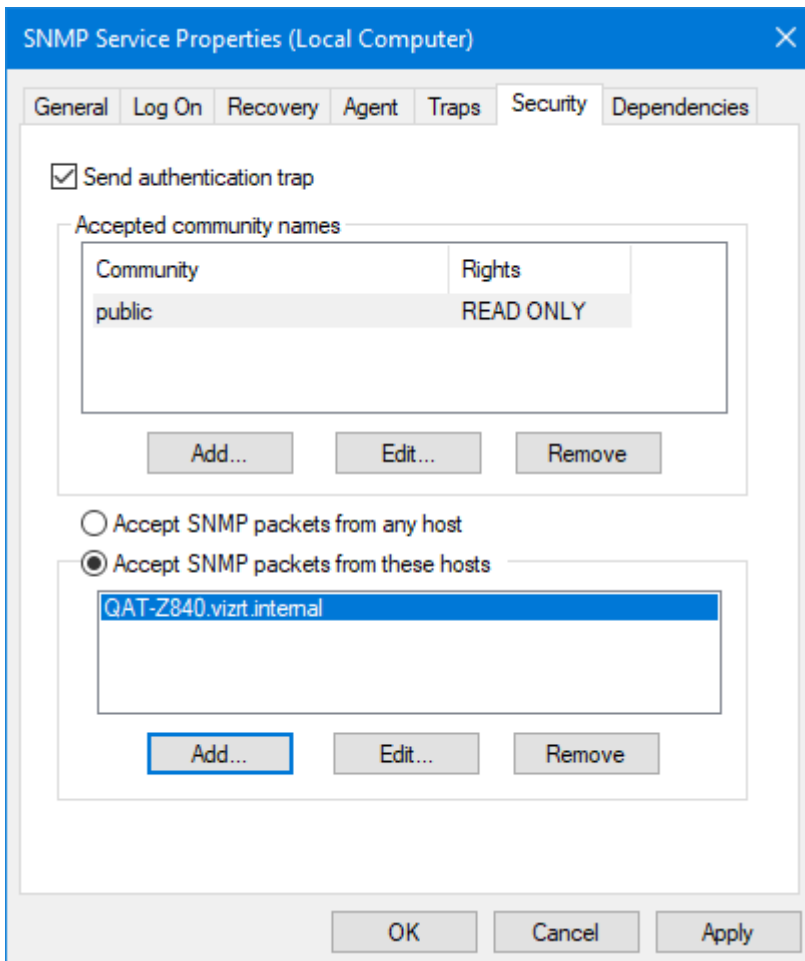

Note: If you want to have active trap notifications, you have to enter the IP destination of your host monitoring system into the trap destinations as the SNMP service forwards the notifications to the monitoring host.

Without the configuration above, the SNMP service appears to be running, but does not send anything and the queries time out.

13.2.3 Installation

Currently there are two DLLs, one for Viz Engine (*VizEngineSnmpExt.dll*) and one for Viz Graphic Hub (*VizGraphicHubSnmpExt.dll*). These files can be copied anywhere to your hard drive, but they need to be registered to the SNMP service. Once the SNMP service recognizes the agents, the DLLs have to be registered in the registry in:

The following registry entries need to be set:

Path	Setting
[HKLM\SYSTEM\CurrentControlSet\Services\SNMP\Parameters\ExtensionAgents]	"9"="SOFTWARE\\vizrt\VizEngineSnmpExt\CurrentVersion"
[HKLM\SOFTWARE\vizrt\VizEngineSnmpExt\CurrentVersion]	"Pathname"="c:\Program Files\vizrt\SnmpExtAgents\VizEngineSnmpExt.dll"

Note: If there are already other services registered, simply increase the index of the new one and add the following to its data value. See above example = "9"

Note: Please remember to restart the SNMP service after applying the settings in the registry.

13.2.4 Configuration

The extension agents were designed to have as few configuration options as possible. The parameters are located in registry and are read when the agent is initialized. The registry location for Viz Engine is *HKLM\SOFTWARE\vizrt\VizEngineSnmpExt*. All parameters are optional. By fulfilling some setup conditions it is possible to install the agents without needing to use the parameters at all.

Registry Key	Default Value	Info
DebugLog	0	Enables debug log level. The log is located at <i>C:\ProgramData\Vizrt\SNMPExtAgents</i> . It should be disabled in production environment.
SampleTime	5000	Sample time in milliseconds for fetching the latest data, from Graphic Hub over REST, for example.
TrapRepeat	36	The agents repeat traps for values in „failed“ condition. The repeat time is $SampleTime * TrapRepeat$. Set to 0 to turn off trap repeating.
TrapHandling	1	Set to 0 to disable sending traps entirely. It is suggested to rather ignore the traps in the monitoring system than disabling them entirely.

Viz Engine specific settings:

Registry Key	Default Value	Info
ChannelCount	(automatic)	By default, the agent determines the maximum viz engine channel count by examining registry at <i>HKLM\SOFTWARE\vizrt\Viz3\PlatformType</i> . You can override this by using 1-4 here.

13.3 SNMP Viz Engine OIDs

This document lists all available OIDs for Viz Engine. *N* represents the current channel, that is *1* is for Viz Engine Channel 1 (first instance).

13.3.1 Viz Engine OIDs

Value OID	Description	Type	Info
27566.1.1.1.N .1	Ready For Connect	TruthValue	Viz Engine is initialized and running (On Air or Off Air).
27566.1.1.1.N .2	On Air	TruthValue	Viz Engine is On Air.
27566.1.1.1.N .3	Connected To Db	TruthValue	Viz Engine is connected to Viz Graphic Hub.
27566.1.1.1.N .4	Post Render Mode	INTEGER normalmode(0), postrendermode(1)	Post render mode active.
27566.1.1.1.N .5	NLE Mode	INTEGER normalmode(0), nlemode(1)	NLE mode active.
27566.1.1.1.N .6	Current Frame Rate	Integer32 (0..10000)	Current frame rate.
27566.1.1.1.N .7	Retrace Counter	Integer32 (0..65536)	Changing number when the engine is rendering.
27566.1.1.1.N .8	Viz Engine Version	OCTET STRING (SIZE (0..128))	Version string.
27566.1.1.1.N .9	System ID	OCTET STRING (SIZE (0..128))	Dongle ID.

Value OID	Description	Type	Info
27566.1.1.1.N .10	Computer Type	INTEGER irix(0), video(1), panasonic(2), pc(3), twc(4), sgipc(5), chyron(6), unknown(7)	
27566.1.1.1.N .11	TCP Port	Integer32 (0..65536)	TCP command port, 6100 or similar.
27566.1.1.1.N .12	Genlock Status	INTEGER ok(0), wrongformat(1), bad(2), droppedframes(3), unknown(4), notavailable(255)	Genlock status.
27566.1.1.1.N .13	Video In 1 Status	INTEGER ok(0), wrongformat(1), bad(2), droppedframes(3), unknown(4), notavailable(255)	Video input status.
27566.1.1.1.N .14	Video In 2 Status	INTEGER ok(0), wrongformat(1), bad(2), droppedframes(3), unknown(4), notavailable(255)	
27566.1.1.1.N .15	Video In 3 Status	INTEGER ok(0), wrongformat(1), bad(2), droppedframes(3), unknown(4), notavailable(255)	
27566.1.1.1.N .16	Video In 4 Status	INTEGER ok(0), wrongformat(1), bad(2), droppedframes(3), unknown(4), notavailable(255)	
27566.1.1.1.N .17	Video In 5 Status	INTEGER ok(0), wrongformat(1), bad(2), droppedframes(3), unknown(4), notavailable(255)	

Value OID	Description	Type	Info
27566.1.1.1.N .18	Video In 6 Status	INTEGER ok(0), wrongformat(1), bad(2), droppedframes(3), unknown(4), notavailable(255)	
27566.1.1.1.N .19	Video In 7 Status	INTEGER ok(0), wrongformat(1), bad(2), droppedframes(3), unknown(4), notavailable(255)	
27566.1.1.1.N .20	Video In 8 Status	INTEGER ok(0), wrongformat(1), bad(2), droppedframes(3), unknown(4), notavailable(255)	
27566.1.1.1.N .21	Clip 1 Status	INTEGER ok(0), wrongformat(1), bad(2), droppedframes(3), unknown(4), notavailable(255)	Clip status.
27566.1.1.1.N .22	Clip 2 Status	INTEGER ok(0), wrongformat(1), bad(2), droppedframes(3), unknown(4), notavailable(255)	
27566.1.1.1.N .23	Clip 3 Status	INTEGER ok(0), wrongformat(1), bad(2), droppedframes(3), unknown(4), notavailable(255)	
27566.1.1.1.N .24	Clip 4 Status	INTEGER ok(0), wrongformat(1), bad(2), droppedframes(3), unknown(4), notavailable(255)	

Value OID	Description	Type	Info
27566.1.1.1.N .25	Clip 5 Status	INTEGER ok(0), wrongformat(1), bad(2), droppedframes(3), unknown(4), notavailable(255)	
27566.1.1.1.N .26	Clip 6 Status	INTEGER ok(0), wrongformat(1), bad(2), droppedframes(3), unknown(4), notavailable(255)	
27566.1.1.1.N .27	Clip 7 Status	INTEGER ok(0), wrongformat(1), bad(2), droppedframes(3), unknown(4), notavailable(255)	
27566.1.1.1.N .28	Clip 8 Status	INTEGER ok(0), wrongformat(1), bad(2), droppedframes(3), unknown(4), notavailable(255)	
27566.1.1.1.N .29	Texture Memory Free	Integer32 (0..2147483647)	Texture memory available in KB.
27566.1.1.1.N .30	Texture Memory Total	Integer32 (0..2147483647)	Total texture memory in KB.
27566.1.1.1.N .31	Texture Memory Used	Integer32 (0..100)	Texture memory used (percentage).
27566.1.1.1.N .32	Renderer Scene Front	OCTET STRING (SIZE (0..1024))	Scene name.
27566.1.1.1.N .33	Renderer Scene Middle	OCTET STRING (SIZE (0..1024))	Scene name.
27566.1.1.1.N .34	Renderer Scene Back	OCTET STRING (SIZE (0..1024))	Scene name.
27566.1.1.1.N .35	Post Scene Front	OCTET STRING (SIZE (0..1024))	Scene name.

Value OID	Description	Type	Info
27566.1.1.1.N.36	Post Scene Middle	OCTET STRING (SIZE (0..1024))	Scene name.
27566.1.1.1.N.37	Post Scene Back	OCTET STRING (SIZE (0..1024))	Scene name.
27566.1.1.1.N.38	Retrace Counter Moving	TruthValue	Computed flag; true if the retrace counter changes. Can be possibly used to detect hanging renderer.

13.3.2 Viz Engine Trap OIDs

On change of some of the important properties a trap (notification) is generated too. This way the monitoring system which is polling the values at regular intervals gets the change immediately. Persisting “failed” values trigger repeated traps.

Trap OID	Description	Value OIDs Included	Info
27566.1.1.1.N.0.1	Ready For Connect Changes	27566.1.1.1.N.1	Sent when state changes or periodically if value is false.
27566.1.1.1.N.0.2	On Air State Changes	27566.1.1.1.N.2	Sent when 27566.1.1.1.N.2 is true and state changes or periodically if value is false.
27566.1.1.1.N.0.3	Db Connection State Changes	27566.1.1.1.N.3	Sent when 27566.1.1.1.N.3 is true and state changes or periodically if value is false.
27566.1.1.1.N.0.4	Genlock State Changes	27566.1.1.1.N.12	Sent when 27566.1.1.1.N.12 is true and state changes or periodically if value is not 0.
27566.1.1.1.N.0.5	Texture Memory Changes	27566.1.1.1.N.29-31	Sent when 27566.1.1.1.N.29-31 is true and state changes or periodically if value is < 10000 KB (hardcoded).
27566.1.1.1.N.0.6	Retrace Counter Changes	27566.1.1.1.N.38	Sent when 27566.1.1.1.N.38 is true and state changes or periodically if value is false.

Trap OID	Description	Value OIDs Included	Info
27566.1.1.1.N.0.7	Renderer Front Scene Changes	27566.1.1.1.N.32	Sent when 27566.1.1.1.N.32 is true and state changes.
27566.1.1.1.N.0.8	Renderer Middle Scene Changes	27566.1.1.1.N.33	Sent when 27566.1.1.1.N.33 is true and state changes.
27566.1.1.1.N.0.9	Renderer Back Scene Changes	27566.1.1.1.N.34	Sent when 27566.1.1.1.N.34 is true and state changes.